

RADIO- TV Experimenter

50 CENTS

Building
or
Servicing **OVER
40
PROJECTS**

- Midget Transistor Sets
- Radio Direction Finder
- Low Cost Speedlight
- Crystal Sets
- Shortwave Receivers
- Radio Telephone Station
- Electronic Detectophone
- Remote Control Fireboat



Hidden Metal Detector



TV Servicing



Electrifying Instruments



**Radio Controlled
Garage Door Opener**



**Get more money!
More security! More out of life!**



**Learn
TELEVISION
• RADIO •
ELECTRONICS**

Get the best!

Get National Schools' SHOP-METHOD HOME TRAINING!

Start now! Why wait around for that raise or promotion that may never come? Get started *now* in high-paying TV-Radio-Electronics! National Schools' SHOP METHOD Home Training prepares you for success in a top-salary job or in your own business. You learn *all three*... Television, Radio, Electronics... in one complete course. Our Shop-Tested lessons and manuals help you master all phases in shortest possible time! Send coupon, find out today!

WHY NATIONAL SCHOOLS LEADS THE FIELD

Located in the "Television Center" of the world, our staff is in close touch with latest developments and opportunities. We give you personalized job placement assistance. We also give you confidential help with both technical and personal problems relating to your training. We show you how to make Part Time Earnings as you progress. Whether you live 30 miles away, or 3,000, you will always be pleased with our prompt, friendly service!

DRAFT AGE? Our home training helps you achieve specialized ratings and higher pay grades if you go in service.

We send you this precision-tested Multitester! Plus parts to build Oscillators, Receivers, Signal Generator, Continuity Checker, Combination Short Wave and Standard



Broadcast Superhet Receiver. All this equipment is part of your National Schools course. **NO EXTRA CHARGES!** Send coupon for free books!

NATIONAL SCHOOLS, world-famous technical trade school. Now entering our 50th year!



**NATIONAL SCHOOLS
TECHNICAL TRADE TRAINING SINCE 1905**

LOS ANGELES 37, CALIFORNIA
In Canada: 811 W. Hastings St., Vancouver, B. C.

- APPROVED FOR C. I. TRAINING
- BOTH HOME STUDY AND RESIDENT COURSES OFFERED

30 MILLION TV SETS

need regular repair! Color TV means more sets than ever before. NOW is the golden opportunity to cash in on this multi-billion-dollar industry. Or "write your own ticket" in broadcasting, manufacturing, and other specialized phases!

**YOUR AGE
IS NO
OBSTACLE!**



**Send for
FREE LESSON!**
FREE BOOK & SAMPLE LESSON
will convince you!
SEND COUPON TODAY!

MAIL NOW TO OFFICE NEAREST YOU!

(mail in envelope or paste on postal card)

NATIONAL SCHOOLS, DEPT. RKK-35

4000 SOUTH FIGUEROA STREET OR 323 WEST POLK STREET
LOS ANGELES 37, CALIFORNIA CHICAGO 7, ILLINOIS

Please rush **FREE BOOK**, "My Future in Radio-Television-Electronics," and **FREE LESSON** at once. I understand there is no obligation, and no salesman will call.

NAME _____ BIRTHDAY _____ 19 _____

ADDRESS _____

CITY _____ ZONE _____ STATE _____

Check if interested **ONLY** in Resident Training at Los Angeles.

VETERANS: Give date of discharge _____

Let me send you this amazing- ELECTRONIC KIT!

OWN THIS ELECTRONIC KIT



\$\$\$

ASSURE YOURSELF OF FINANCIAL SECURITY—INDEPENDENCE

Imagine being able to fix anything electrical from the tiniest home electric shaver to large industrial motors! Having a training that makes you command a better job with higher wages or a business of your own. You do not need previous special schooling. Just the ability to read and be mechanically inclined. We furnish you with everything! One of the kits sent to you is our famous ELECTRONIC KIT, an all-purpose trouble detector which shows you where the trouble lies. Training kits whose assembly will give you practical shop training at home during your spare time!



You learn practical electricity by using your hands. Best of all, these kits are yours to keep and use forever!



REPAIR ELECTRICAL EQUIPMENT!

ILLUSTRATED COURSE SHOWS EVERYTHING

R. S. FRAZER

The Christy maintenance and repair course is written in simple, easy-to-understand language. Each section is profusely illustrated by photographs and drawings and shows you what troubles to look for and then how to correct them. In addition, our course shows you how to build power tools at low cost. Also teaches you welding, nickel plating, general repairing (saw filing, bicycle and gas stove repairing, etc.). Should complicated technical problems arise or the need for a special repair part, simply call on us. We offer YOU our FREE Advisory Service for LIFE! We teach you how to solicit business get repeat orders and what to charge. The Christy Course plus our home shop training kits make a combination that will go a long way toward ASSURING YOUR SUCCESS.

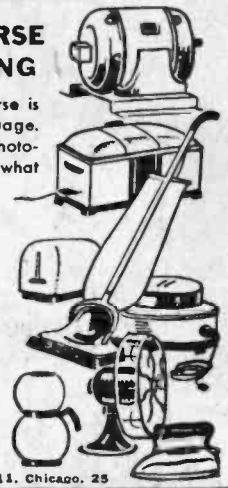

3 EASY STEPS TO SUCCESS

- 1 WE SEND YOU AN ELECTRIC KIT
- 2 WE TEACH YOU ELECTRICAL APPLIANCE REPAIRING
- 3 WE GIVE YOU LIFE-TIME ADVISORY SERVICE

Rush name for FREE book and pay later. Form Christy Trades School, 4804 N. Kedzie Ave., Dept. D-211, Chicago, 25

RUSH THIS COUPON TODAY!

**CHRISTY TRADES SCHOOL, Dept. D-211
4804 N. Kedzie Ave., Chicago 25, Ill.**

Please send me your FREE book on Electric Equipment Servicing and instructions for paying later from EARNINGS WHILE LEARNING!

Name..... Age.....

Address.....

City..... Zone..... State.....

RADIO-TV Experimenter

VOLUME THREE

CONTENTS

| | | | |
|-----------------------------------------------------|----|-----------------------------------------|-----|
| Hidden Metal Detector..... | 9 | Pocket-Size Tube Checker..... | 86 |
| Wireless Electronic Detectophone..... | 13 | Amateur Radiotelephone Station..... | 88 |
| Fountain Pen Radio..... | 16 | Novel Uses for Old Radio Parts..... | 95 |
| Small-Fry Television Silencer..... | 17 | TV Antenna Coupler..... | 96 |
| Twin Speakers Improve Fidelity..... | 18 | Solder Clipped to Iron Cord..... | 97 |
| Repairing TV Sets..... | 19 | Pint-Sized Loudspeaker Radio Receiver.. | 98 |
| Electronify Your Musical Instruments.... | 32 | Holder for Soldering Gun..... | 100 |
| Remote TV-Radio Sound Silencer..... | 35 | Secret Switch for Table Radio..... | 100 |
| Transistor Pocket Radio..... | 36 | Versatile TV Stand..... | 101 |
| Building a Low-Cost Speedlight..... | 38 | One-Tube Cigar-Box Amplifier..... | 104 |
| Radio Direction Finder for \$2..... | 42 | Shortwave Adapter..... | 106 |
| Emergency Twin-Crystal Radio Receiver.. | 45 | Cutting Screws to Length..... | 108 |
| Pocket Power Pack..... | 47 | Combination Bed Lamp and Crystal Set.. | 109 |
| AM-FM-TV Wireless Record Player..... | 49 | General Purpose AC Amplifier..... | 113 |
| Mite-Size Radio..... | 52 | Clip Holder Keeps Service Manual Open | 116 |
| TV-Audio Timer..... | 54 | Pocket Signal Tracer..... | 117 |
| You Can Fix That Ailing Radio..... | 56 | Signal-Booster for Loop..... | 119 |
| Mounting Coil Forms on Chassis..... | 61 | Trapping TV Interference..... | 120 |
| Converting Your TV to Receive UHF.... | 62 | Putting 'Electric Eyes' to Work..... | 122 |
| Telephone Amplifier..... | 67 | Little Squirt..... | 126 |
| Winding Small Coils..... | 70 | Popular Multi-Com..... | 137 |
| Pipe Cleaner File..... | 71 | S&M Data Sheet—Radio Symbols..... | 140 |
| Hi-Fi Boost for Your Table-Size Radio or TV..... | 72 | Useful Tables and Formulas..... | 141 |
| Remote Speaker for Your Car Radio.... | 75 | Precision Electronic Timer..... | 144 |
| Handy Counter From Radio Dial..... | 76 | Portable Short-Wave Receiver..... | 148 |
| Uke-Atron..... | 77 | Short-Wave Converter..... | 151 |
| Giant Loop Crystal Set..... | 80 | Homemade TV Antenna..... | 154 |
| Movie Reels Store Wire or Cord..... | 81 | Transistor Code Practice Set..... | 156 |
| Line Voltage Corrector for Your TV Receiver..... | 82 | Fire Alarm..... | 158 |
| Ventilate Your TV Set..... | 85 | Noise Filter for Record Playing..... | 167 |
| | | What to Look for in Buying Hi-Fi..... | 168 |
| | | Remote Control Garage Door Opener.. | 176 |

Published and Copyrighted 1955 by

**SCIENCE AND MECHANICS
PUBLISHING COMPANY**

450 East Ohio Street, Chicago 11, Illinois

The Radio-TV Experimenter is a selected group of popular articles, most of which appeared in SCIENCE AND MECHANICS magazine. The Editors have brought together in one handy volume a series of projects for those who want to build or repair radios or television sets, who want to do experimental work in these lines and those who want to try other interesting projects.

V. D. ANGERMAN
Editor and Publisher

DON DINWIDDIE
Managing Editor

ART YOUNGQUIST
Home Workshop Editor

P. D. URBAIN
Associate Editor

L. G. ANDERSEN
Associate Editor

F. M. EISENZOPH
Art Director

Cover by Arthur C. Bade

Now IN YOUR OWN HOME Learn

**TELEVISION
RADIO
ELECTRONICS**

the Amazingly Effective

D. T. I. WAY

**—with the aid of BOTH
HOME EQUIPMENT
and HOME MOVIES**

NO PREVIOUS EXPERIENCE NEEDED
NOW... get

**EVERYTHING
YOU NEED**

for real Laboratory-
type training
AT HOME

What will mailing the coupon below do for YOU? Just this! You'll find out about one of today's most remarkable... practical ways to prepare to get into America's amazing billion dollar opportunity field of TELEVISION-RADIO-ELECTRONICS. You'll see how to get into fascinating work that pays well... that offers one of America's most promising futures... that enables you to start your own business almost "on a shoe string," if you prefer this to a job opportunity.

And above all, you'll get some GOOD NEWS especially welcomed by men anxious to earn REAL MONEY in this thrilling field. For you'll see that NOW you can get the kind of practical, laboratory-type training so desirable for making real progress in Television-Radio-Electronics AND WITHOUT LEAVING HOME.

You'll see that DeVry Technical Institute sends everything needed to set up your own HOME LABORATORY.

You get and keep the same type of basic electronic equipment used in our modern Chicago Training Laboratories. You get home training that includes the knowledge and experience gained from training thousands of students first hand in Chicago.

And to top it all, you use DTI's amazingly effective and exclusive home training aid—INSTRUCTIVE MOVIES. But why not get the complete story? Mail coupon today for information-packed literature.

MODERN LABORATORIES

If you prefer, get all your preparation in our new Chicago Training Laboratories—one of the finest of its kind. Ample instructors, modern equipment. Write for details!

MILITARY SERVICE!

If you're subject to military service, the information we have for you should prove very helpful. Mail coupon today.

Above:
Work over
300
fascinating
experiments
with this
equipment

1. Build over 300 fascinating experiments from 16 BIG SHIPMENTS of Electronic-Radio parts which you KEEP.
2. Build valuable commercial-type test equipment—as shown to the left—which you KEEP. This includes a quality 5 INCH oscilloscope and jewel bearing Multi-Meter—both highly useful for Television work.
3. Build and keep a big 21 INCH TV Set. (D.T.I. offers another home training in Television-Radio-Electronics, but without the TV set.)
4. Use a 16 mm. movie projector and new series of highly instructive movies—a wonderful aid to help you grasp important fundamentals faster... easier... better.
5. Enjoy well-illustrated, easy-to-read lessons with handy FOLD-OUT diagrams.
6. Get an honest-to-goodness EMPLOYMENT SERVICE to help you get a good job after graduating—or assistance in starting your OWN SALES AND SERVICE BUSINESS. Mail coupon today for the complete details.

D.T.I.'s Training is available in Canada

Get this
information-
packed
publication
FREE!

Mail Coupon Today



Oscilloscope



Multi-Meter



Build and keep this BIG DTI Engineered TV set—easily converted to U.H.F. (DTI offers another home training, but without the TV set.)

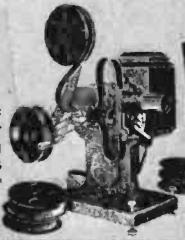

89 WAYS TO EARN MONEY IN TELEVISION RADIO ELECTRONICS

"ONE OF AMERICA'S FOREMOST TELEVISION TRAINING CENTERS"

DEVRY TECHNICAL INSTITUTE
AFFILIATED WITH
DzFOREST'S TRAINING, INC.
CHICAGO 41, ILLINOIS

**DEVRY TECHNICAL INSTITUTE Dept. RTV-3-L
4141 BELMONT AVE., CHICAGO 41, ILL.**

I would like your valuable information-packed publication showing how I can get started toward a good job or my own business in Television-Radio-Electronics.

Name.....Age.....
Street.....Apt.....
City.....Zone.....State.....

VETERANS! — NON-VETERANS!

WANTED
-200,000 TV
SERVICE MEN!



GET IN ON THIS
2 BILLION DOLLAR PLUM!

200,000 — That's how many service men will be needed to handle radio-television-electronics industry requirements in the next few years. That's the figure given in a recent speech by Harold J. Schulman, director of product service for CBS-Columbia — a man in a position to know.

2.7 billion dollars being spent just for service and installation of TV sets in American homes by 1957!

That's the figure given in another speech recently by one of the top men in the entire industry — Frank M. Folsom, president of the Radio Corporation of America.



I. C. Lane, B.S., M.A.
 President, Radio-Television Training Association.
 Executive Director, Pierce School of Radio & Television.

THINK
WHAT THIS CAN
MEAN FOR YOU!

Here is a field still in its infancy — New jobs with top pay and a secure future are being created everyday — Here is a chance for you to get into an ever-expanding field with unlimited opportunity for advancement — Here is your chance to set up your own business and be your own boss — Here is your opportunity to get in on a 2 billion dollar plum by becoming a Television Technician.

TRAINED MEN
GET THE
TOP JOBS!

Top-paying jobs go to the men who prepare themselves. You can prepare yourself without giving up your present job or interfering with your social life. My lessons are especially prepared for you to study at home — even if you have absolutely no experience in this field. All you need is a grammar school education or its equivalent — and the sincere desire to prepare yourself for a better future and a chance to make more money.

VETERANS!

My school fully approved to train Veterans under new Korean G.I. Bill. Write discharge date on coupon.

I CAN DO FOR YOU WHAT I DID FOR THESE MEN:

AIRCRAFT INSPECTOR AT GOOD PAY

"With RTTA training and through repairing radios and televisions for the right people at the right price, I was able to make the right contacts. I am now an Inspector for Douglas Aircraft at about \$125 a week."



Hugh Maddox,
 Los Angeles, Calif.

MANAGES TWO SHOPS

"I manage two radio and television shops, one here and one in Pompano Beach. RTTA training increased my knowledge of TV circuits and showed me new, quicker methods of repairing. Lessons as presented are very concise and clear."



William Phillips,
 Fort Lauderdale, Fla.

\$60 A WEEK IN SPARE TIME

"I have the skill and know-how to do the work I love best and to enjoy better things in life, thanks to RTTA. I am working at TV servicing and making \$60 a week spare-time."



Harold Gimlen,
 Flint, Michigan

RADIO-TELEVISION TRAINING ASSOCIATION—52 E. 19th Street, New York 3, N. Y.

← CHOOSE FROM
THREE COMPLETE COURSES

My courses cover all phases of Radio, FM and TV

1. Radio, FM and Television Technician Course— No previous experience necessary.

You learn by practicing with the professional equipment I send you. Many of my graduates now hold top-paying technician jobs with such firms as RCA, NBC-TV, CBS-TV, Dumont TV and other TV studios and plants.

2. FM-TV Technician Course — previous training or experience in radio required.

You can save months of time if you have previous Armed Forces or civilian radio experience! Train at home with kits of parts, plus equipment to build **BIG SCREEN TV RECEIVER**. ALL FURNISHED AT NO EXTRA COST!

3. TV Cameraman and Studio Technician Course—advanced training for men with Radio or TV training or experience.

I train you at home for an exciting top pay job as the man behind the TV camera. Work with TV stars in TV studios or "on location" at remote pick-ups!

An optional 30-hour, one week course of practical work on TV studio equipment at Pierce School is offered upon completion of Course 3.

FREE FCC COACHING COURSE

Important for **BETTER-PAY JOBS** requiring FCC License. You get this training AT NO EXTRA COST! Top TV jobs go to FCC-licensed technicians.

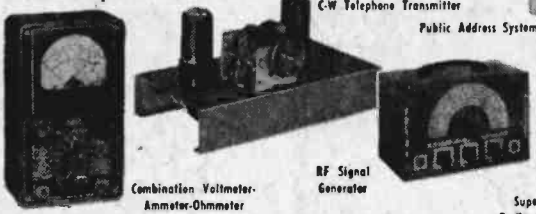

LEARN BY DOING

As part of your training, I give you the equipment you need to set up your own home laboratory and prepare for a **BETTER PAY TV JOB**. You build and keep a professional **GIANT SCREEN TV RECEIVER** complete with big picture tube (designed and engineered to take any size up to 21-inch) . . . also a Super-Hot Radio Receiver, RF Signal Generator, Combination Voltmeter-Ammeter-Ohmmeter, C-W Telephone Transmitter, Public Address System, AC-DC Power Supply. Everything supplied, including all tubes.

EARN WHILE YOU LEARN!

Almost from the very start you can earn extra money while learning by repairing Radio-TV sets for friends and neighbors. Many of my students earn up to \$25 a week . . . pay for their entire training from spare time earning . . . start their own profitable service business.

FREE!

I'LL SEND YOU MY NEW BOOK, "HOW TO MAKE MONEY IN TELEVISION, RADIO, ELECTRONICS," A FREE SAMPLE LESSON, AND OTHER LITERATURE SHOWING HOW AND WHERE YOU CAN GET A BETTER PAY JOB IN TELEVISION.

HAS OWN BUSINESS

"I have a shop at home and have been working on radio and TV after working hours of my regular job. I average \$50 a week for this part time work. RTTA training helped me in making extra money and giving me experience in the electronic field."



Richard Hennis, Little Rock, Ark.



**MAIL THIS 'COUPON TODAY!
NO SALESMAN WILL CALL!**

Mr. Leonard C. Lane, President
RADIO-TELEVISION TRAINING ASSOCIATION
Dept. M-2, 52 East 19th Street, New York 3, New York
Dear Mr. Lane: Mail me your NEW FREE BOOK, FREE SAMPLE LESSON, and FREE aids that will show me how I can make BIG MONEY IN TELEVISION. I understand I am under no obligation and no salesman will call.

(PLEASE PRINT PLAINLY)

Name _____ Age _____

Address _____

City _____ Zone _____ State _____

I AM INTERESTED IN:

Radio-FM-TV Technician Course

FM-TV Technician Course

TV Cameraman & Studio Technician Course

VETERANS!
Write discharge date



Which of these How-to-Do-It Books Do You Want for Only 50¢?

8 Big Illustrated Books • Every One a Gold Mine of Ideas for Making and Repairing Things

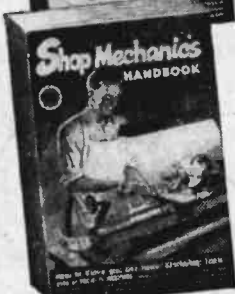
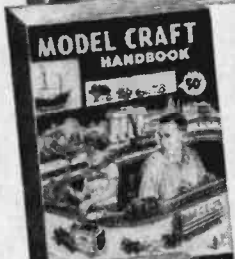
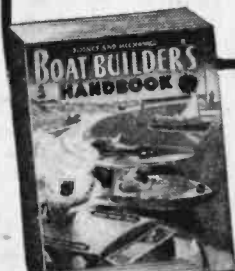

Here's a whale of a bargain! 8 big books that show you exactly "how-to-do-it" and get professional results every time! Every one is jam-packed with pictures and simple step-by-step directions. Only 50¢ each. (Or even better, you can have all eight for only \$3.) Just pick the ones you want—rush coupon below while present supply lasts! Money back if not delighted.

11 SPORTS CRAFT HANDBOOK

How to build, use, repair outdoor sports equipment. Covers outdoor motors; guns, boats, fishing tackle, archery, golf, etc. How to restring tennis rackets, tie flies, make spinning rods, build swimming pool, overhaul canoe, build cruiser, sailboat, folding sled, reloading ammunition, and much more. 160 pages.

12 PHOTO CRAFTSMAN

Over 90 fascinating projects! Complete basic course in photo developing. How to make and use: flash-gun, enlarger, movie titler, speed-light, strobograph, electrical timer, boom light, copying stand, rotary print washer, projector, print flattener, camera bellows, coldlight enlarger, etc. Plus complete plans for apartment darkroom. 160 pages.

14 DO-IT-YOURSELF HANDBOOK

Big home-owner's treasury shows HOW TO: finish wood floors, install ventilating fans, plaster rooms, tile floors, install Thermopane windows, build furniture, make lamp shades, patch plywood, service appliances, plus 34 pages of home furnishing accessory ideas—all with step-by-step photos, plans and diagrams. 160 pages.

4 CRAFTSMAN'S HANDBOOK

Over 60 useful things to make—Tables, Cabinets, Captain's Chair, Early American Furniture, Simple Upholstery, Dressing Table-Desk, Toys, Sailing Dinghy, Wall Bracket, How to do Veneering, Wall Safe, Pantograph, Functional Furniture, and much, much more. 192 illustrated pages.

5 BOAT BUILDER'S HANDBOOK

33 boats you can build yourself. Everything from sailing dinghy to cabin cruiser. Duck boats, hydroplane racer, kayak-canoe, motor sailer, sea sled, rowboat, runabout, folding boat, scow sailer, all-purpose sloop. How to take care of your boat, tips on care of outboard motor. How to recondition your boat, make full-size boat plans, etc., etc. 192 pages.

6 CRAFTWORK

Fascinating projects using simple tools. Decorative Candle-making, Chipcarving, picture framing, floral jewelry, hooked rugs, ceramic mold making, silversmithing, wire bending, pewter platters, wood carving, making molds, hand-made tie clips, sandals, and many other projects, plus a complete course in leathercrafting. 192 pages.

7 MODEL CRAFT HANDBOOK

A prize collection of 44 model projects—Model Railroad and Circus, Working Jet Engine, Famous Guns, Airplanes, Antique Autos, Gas and Steam Engines, Tallyho Coach, Model Racing Yacht, Remote Radio Controlled Cabin Cruiser, 1812 Cannon, 1850 Station Wagon, etc., etc. 192 big pages, many pictures.

8 SHOP MECHANIC'S HANDBOOK

Everything you want to know about building and using home workshop tools. Lathe, Bench Grinder, etc. Treasure of ideas. 192 pages.

SPECIAL
All 8
FOR ONLY
\$3.00

SAVE MONEY!

If you order 2 or more books, you save 10¢ on each book! On 2 books, you deduct 20¢; on 3 books 30¢, etc. All 8 for only \$3.00.

—RUSH THIS ORDER FORM—

Science & Mechanics Magazine, Dept. R255
450 East Ohio Street, Chicago 11, Illinois

Enclosed is \$_____ Please send the books whose numbers I have encircled below. (Numbers correspond with descriptions above.)

or CHECK BOX TO GET ALL 8 BOOKS (\$4.00 VALUE) **\$3.00**

4 5 6 7 8 11 12 14

NAME _____

ADDRESS _____

CITY, ZONE & STATE _____

NOW... Start Fixing TV and Radio Sets RIGHT AWAY

TRY IT
FREE
FOR 10 DAYS IN
YOUR OWN HOME

TELEVISION
AND RADIO
REPAIRING

McGraw-Hill's Amazing New Low-Cost Instruction Manual Skips "Theories" and "Formulas", Tells How-to-do-it in PLAIN ENGLISH!



Prove It on Your Own Set

Save up to \$50 a year just by installing, repairing, and servicing your own TV set. Book tells which controls to adjust or tubes to replace if picture is entirely dark — blurred — split — distorted — off center — tilted — wiggles and weaves — too pale — too black — jitters — snows — drifts — etc., etc.

PARTIAL CONTENTS

Tools Needed • How TV and Radio Sets Work • How to Remove and Replace Tubes • Testing Tubes without a Tester • Using a Tube Tester • Power-Supply Troubles • How to Test Switches, Condensers, Coils, Transformers • Tuning Devices • Loudspeakers • Phono Pickups and Needles • How to Install and Repair Antennas • MUCH MORE . . . and

TELLS HOW TO "Cash In" ON THE BIG DEMAND FOR RADIO-TV REPAIRMEN

Over 25 million TV sets . . . over 100 million radios in this country! Shortage of skilled repairmen! You can make nice extra money just fixing sets for friends and neighbors in your spare time . . . or start your own full-time repair business with steady profits. Book tells exactly how to get started; how to plan your workshop; which tubes to stock; where to get information; how to make a service call. You can start fixing sets and making money before you're halfway through the book. Author tells how tough jobs can be done so you STILL make money.



... even if you have never fixed a LAMP or DOOR BELL before!

"Why hasn't somebody done this BEFORE?" That's what you'll say the minute you start browsing through this amazing new and complete one-volume instruction-manual in radio and TV repairs.

For here at last a well-known EXPERT has found a way to tell you in PLAIN ENGLISH how to fix almost ANY radio or television set. (And he even tells you where you can go to have the extra-tough jobs done FOR you . . . at professional rates.) Right from the very first chapters you can start doing simple repairs . . . and before you're HALF way through the book, you can fix HALF the television and radio sets that you encounter. Surprisingly quickly you can fix your own and friends' sets . . . get a service shop job . . . even start your own money-making business right in your own home.

Why It's So EASY to Understand

No electronic formulas . . . no algebra . . . no laboratory experiments. Instead you deal ONLY with the things that go wrong in sets—how to recognize and spot the trouble—and what to do about it. "Easy as A-B-C" directions and 700 clear photos, diagrams, and drawings show you exactly WHAT and HOW to fix, step-by-step.

The author is Associate Editor of *Electronics Magazine*. He's a long-recognized expert—not only on radio and TV—but also on making technical subjects easily understood by the average reader. He has spent FOUR years making this one-volume instruction manual so practical and easy-to-understand that even a man who never fixed a door bell before will have no trouble.

Here's everything you need to know about where and how to buy tubes and parts, where and how to get a circuit diagram for any receiver; how to choose and use basic tools; how to test tubes WITHOUT a tube tester; how to adjust 58 common TV controls; how to "diagnose" and "cure" common radio and TV troubles; how to fix or replace loudspeakers, phono pickups; how to install and check antennas; and much, much more.

SEND NO MONEY

Examine this big 556-page book for 10 days BEFORE you decide if you wish to own it. Try it out FREE on your own set. See how easy it makes your handling of repairs. Take 10 days to prove it PAYS FOR ITSELF, or don't keep it. Just mail coupon to: McGraw-Hill Book Co., Inc., Dept. SM-3, 327 West 41st St., New York 36, N. Y.

FREE 10-DAY TRIAL COUPON

McGraw-Hill Book Co., Inc., Dept. SM-3, 327 West 41st St., New York 36, N. Y.

Please send me, for 10 days' FREE EXAMINATION, your one-volume "Television and Radio Repairing," by John Markus. If not delighted with it, I may return book, pay nothing. Otherwise, I will keep book and send only \$1.95 plus postage; followed by 3 monthly installments of \$2.00 each.

Name

Address

City.....ZoneState.....

SAVE MONEY. Check here if enclosing full price of \$7.95 WITH coupon. Then WE will pay delivery. Same 10-day return privilege—full refund.

Trouble-Shooting Chart Tells Where to Look for Bad Tube If:

No picture; no raster; no sound.
No picture; raster OK; no sound.
No picture; no raster; sound OK.
No picture; raster OK; sound OK.
Picture wiggles and weaves, lacks blacks, or is very black; raster OK; sound OK.
Picture jittery, double image; raster OK; sound OK.
Snow on all channels; raster OK; sound weak.

Snow on all channels, raster OK; sound OK.
Picture and raster do not fill screen; sound OK.
Picture drifts up and down but not sideways; raster OK; sound OK.
Picture muddy and gray; raster OK; sound OK.
PLUS 29 OTHER COMMON TV TROUBLES.

**SCIENCE and
MECHANICS'
DO-IT-YOURSELF
LIBRARY**

Boat Builder's Handbook
Build It Yourself
Car Owner's Handbook
Craftsman's Handbook
Craftwork
Do-It-Yourself Handbook
Handyman's Electrical Guide
Home Owner's Handbook
Home Workshop Handbook
Model Craft Handbook
Photo Craftsman
Shop Mechanic's Handbook
Sports Craft Handbook
Toys and Games
You Can Make

Copyright 1955 by
SCIENCE AND MECHANICS
Publishing Company
450 East Ohio Street
Chicago 11, Illinois

RADIO-TV Experimenter

Hidden Metal Detector

This electronic locator tracks down electric cables, plumbing and other concealed metal objects around the home. Although it won't find gold for you, it will save much more than you'd probably ever find

By THOMAS A. BLANCHARD

Radio-TV Editor

SINCE none of us possess X-Ray vision, locating concealed electrical wiring and plumbing often results in undue damage to walls, when repairs or alterations are made around the home. With this simple metal locator, you can trace the route of BX cable, conduit, water and steam pipes (Fig. 2). When the device is correctly adjusted, you can even locate pipe unions, tees and other hidden fittings.

Outdoors, the metal locator will spot buried fuel oil tanks, and shallow buried cables or pipes (Fig. 1). With the modern cold-process asphalt paving over chucked concrete and brick streets, utility street shut-off valves and manhole covers are frequently "lost." This device will find them in a hurry without tearing up the street in half a dozen places.

A simple, and compact version of the so-called *treasure finder*, this locator consists of two integrated circuits: A Hartley oscillator and a super-regenerative receptor (Figs. 3 and 5). The oscillator transmits a constant-tone signal which is received by the super-regenerative detector circuit when the former's coil approaches a metal object. When the tone signal reaches its maximum volume, the oscillator's exploring coil or probe will be directly over a small metal object. Larger objects produce a broader effect, but there is a pronounced falling off of signal strength as the probe reaches the edges of the concealed mass.

The metal locator is assembled on a small chassis fashioned from aluminum, copper or steel (Figs. 4, 6 and 7). All components are regular radio variety, mounted and wired as shown in Figs. 5, 6 and 7. The receptor coil is a ferrite slug-tuned antenna coil mounted between the two 7-pin miniature tube sockets. The oscillator coil is homemade and plugs into the chassis by means of a 3-pin midget Amphenol plug and socket.

While the chassis could have been mounted in a smaller housing, a cigar box provides enough room for stowing the probe and handle when not in use (Figs. 8 and 9). The exploring coil was wound on a 5/8-in. thick piece of 5 1/4 x 7 1/4-in. kiln-dried pine. (Fig.



Fig. 1. Utility shut-off valves, tanks and shallow cables buried under asphalt, concrete or soil are located by whistle in headphones. Fig. 2. Using locator to trace route of electrical wiring or plumbing concealed in walls or floors, prior to making home repairs or alterations requiring cutting into walls.

10.) Cut a $\frac{3}{8}$ -in. wide, $\frac{1}{2}$ -in. deep groove all the way around the edges of this board with a saw. This groove or recess holds the coil winding securely. Drill holes through this recess for the three wire leads that come up and over to the 3 lug tie strip (Figs. 2 and 10).

In winding the exploring coil, you don't have to count the turns, or have them in a neat row. So long as the winding is tight, the coil can be scramble-wound. Measure off two lengths of No. 24 enameled or double cotton-covered (DCC) magnet wire, each 23 ft. long, or a total of 46 ft. of wire. Secure a 3-lug tie strip to the board and solder one end of the magnet wire to an outside lug. Now wind on 23 ft. of wire and solder its end to the center lug.

Take up the remaining 23 ft. length of wire, solder it to the center lug and wind this in the slot, terminating the end on the other outside tie strip lug. *Make sure you wind both coils in the same direction!* If the first winding is clockwise, be sure the second is also. Note, too, that you may have some wire left at the last turn of each winding which is not enough for another go 'round. Simply terminate coils as near the end of the wire as possible and clip off the excess.

A length of broomstick handle inserts in a $\frac{7}{8}$ or 1-in. hole drilled in the center of the probe. A strip of plastic electrical tape around the end

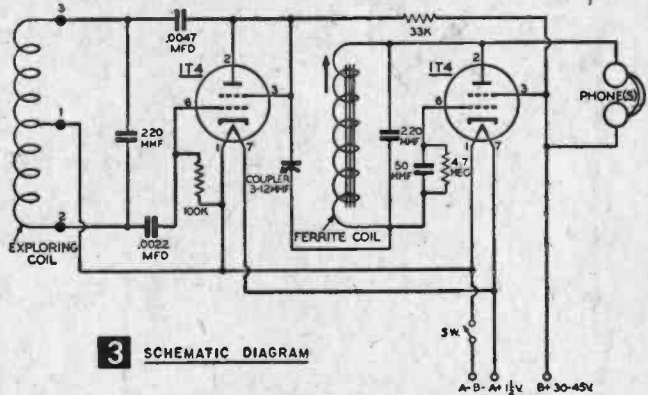

3 SCHEMATIC DIAGRAM

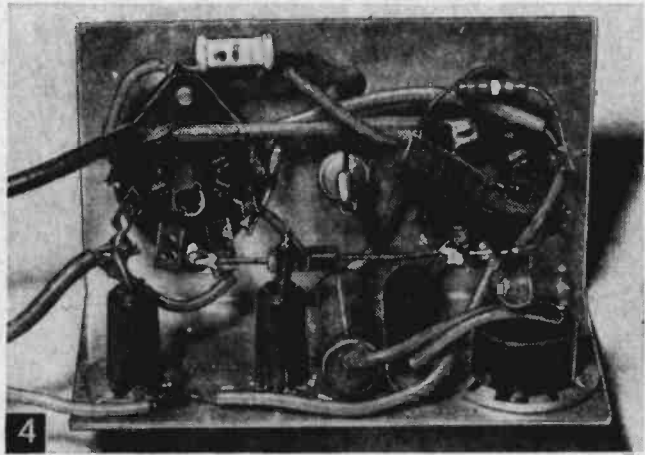

Unobstructed space in center of chassis permits free access to tuning slug of antenna coil. Paper capacitors are midget molded types.

MATERIALS LIST—HIDDEN METAL DETECTOR

- 1 piece light metal for chassis, 3 x $3\frac{1}{4}$ "
- 1 ferrite slug-tuned radio antenna coil*
- 1 spool #24 enameled or DDC magnet wire
- 1 SPST Toggle Switch
- 2 7-pin miniature tube sockets (wafer or molded)
- 2 phone tip jacks (Bakelite)
- 1 3-pin battery cable plug and socket-Amphenol 71-3S and 78-53S
- 2 IT4 tubes
- 1 B Battery, Eveready #413 or #413E (see text)
- 1 A Battery, single flashlight cell, Size C or D
- 1 1000 ohm Alnico headpiece

CAPACITORS

- 1 50 mfd fixed ceramic
- 2 220 mfd fixed ceramic
- 1 .0022 (or .002) mfd molded paper, 200 w.v. midget type
- 1 .0047 (or .005) mfd molded paper, 200 w.v. midget type
- 1 3.3 mfd fixed ceramic or (better) Erie variable Ceramicon #557, 3-12 mfd

RESISTORS

- 1 33K (13,000) ohm $\frac{1}{2}$ watt composition resistor
- 1 100K (100,000) ohm $\frac{1}{2}$ watt composition resistor
- 1 4.7 megohm $\frac{1}{2}$ watt composition resistor

MISCELLANEOUS

- Cigar box, one $\frac{5}{8}$ x $5\frac{1}{4}$ x $7\frac{1}{4}$ piece pine, broomstick, hook-up wire and cable.

*Available for \$1 pp. from Electromite, Box 636, Springdale, Conn.

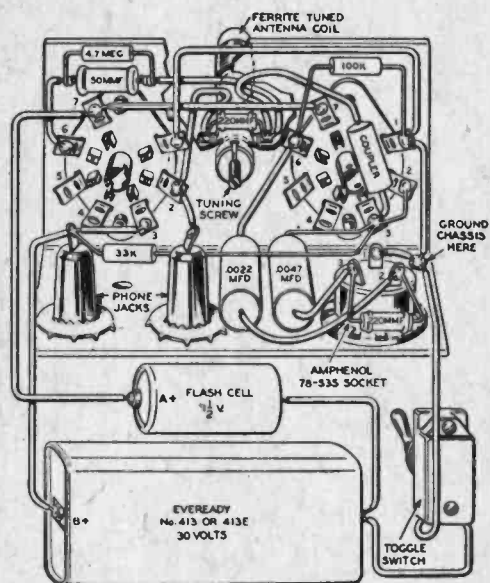

5 PICTORIAL DIAGRAM

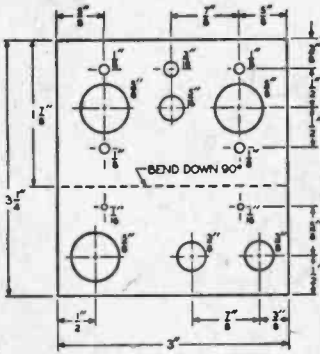

6 CHASSIS LAYOUT
(LIGHT ALUMINUM,
COPPER OR STEEL)

Tiny chassis is of light metal. Chassis apron carries 3-pin socket and phone tip jacks.

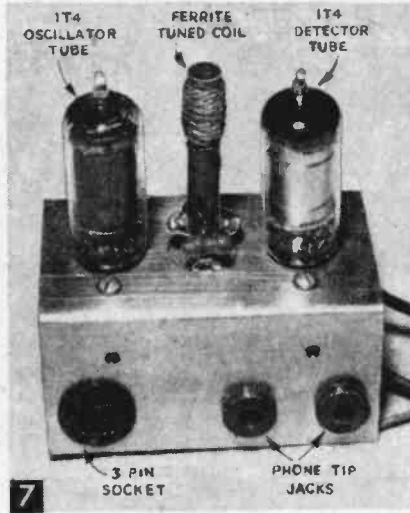

tery. The A battery is an ordinary 1½ volt size C or D flashlight cell. You can mount batteries inside the box cover with a stout rubber band which hooks to two plastic dime store garment buttons (Figs. 8 and 9). Two 3/16-in. holes in the box cover clear the button hooks.

The success of this handy instrument depends upon it being precisely adjusted. With probe plugged in and toggle switch in on position, open the box lid and slowly turn the slug screw on the ferrite-tuned antenna coil until

of the handle (Figs. 8 and 9) will insure a good friction fit if the hole proves oversized.

While this circuit proved very stable, don't use any metal brackets or swivels to secure the handle. A 3-wire cable about two feet long is fitted with an Amphenol #71-3S plug. The other end of the cable terminates on the tie strip. Be sure the cable leads are connected as shown in Fig. 10. Cable shouldn't exceed 2 ft. because its added capacitance may tune oscillator beyond receptor's range. In that case, the 220 fixed ceramic capacitor across the exploring coil would have to be reduced to some lower value.

Lacking a regular 3-wire cable, plastic hookup wire may be taped or laced together for the purpose. Originally, we operated the locator with a loop built into the back of the cigar box. However, much greater sensitivity resulted when the exploring coil was removed from the metallic influence of the chassis and batteries.

The metal locator operates on a 30 volt Eveready No. 413 or 413E radio or hearing aid B bat-

tery. This indicates the device is working and there is nothing wrong with your wiring, assuming the tubes are okay and battery has full voltage.

Now take a metal object such as a pie tin and approach the exploring coil. This should cause a distinct change in the tone heard in the headphone. With the tin about 4 in. from the coil, adjust the ferrite coil again for a loud signal. This time the signal should drop off as the metal is backed off from the exploring coil. Continue to move the tin farther away from the coil, again adjusting the ferrite slug screw. When correctly adjusted, the tone heard in the headphone should be quite faint, increasing to a shrill whistle as a metallic object is brought toward the exploring coil.

There remains one more adjustment that is shown as a fixed value in this unit, but which was predetermined with a variable capacitor. The optimum value of the coupling capacitor between the oscillator and detector circuit will

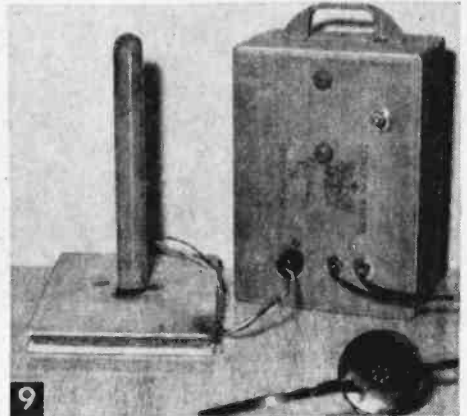
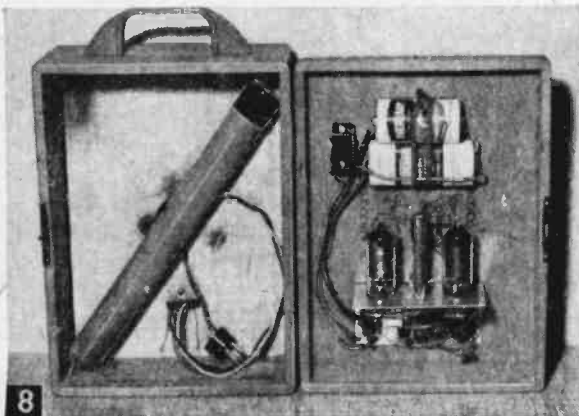

Electronic chassis and batteries mount on lid of non-metallic cigar box for easy adjustment. Note how metal locator, exploring coil and earphone store inside cigar box (Fig. 8). Carrying handle is dime store plastic drawer pull.

IT'S NEW! IT'S FREE!
1955 Walter Ashe Catalog
of Radio, Electronics and TV



The Treasure Chest of Values!

Features all the leading brands of Communication Equipment, Test Instruments, Build-it-Yourself Kits, Hi-fi, Sound and Recording Equipment, Radio, Electronics and TV Parts and Supplies for every conceivable need... In stock—ready for immediate delivery. A "must" for experimenters, amateurs, servicemen, engineers, builders and "hi-fiers."

Walter Ashe
RADIO CO.
 1125 PINE ST. • ST. LOUIS 1, MO.

Send for your **FREE Copy**

MAIL COUPON TODAY!

WALTER ASHE RADIO CO. RE-55
 1125 Pine St., St. Louis 1, Mo.

Rush FREE Copy of New 1955 Catalog.

Name _____
 Address _____
 City _____ Zone _____ State _____

RADIO CONTROL EQUIPMENT

RADIO CONTROL FOR GARAGE DOOR

FROM YOUR CAR—NO FCC LICENSE REQUIRED

TRANSMITTER KIT: Incl. 6 V. Dynamotor, 27 1/2 Mc Crystal, Tube, Cab., Wound Coil, Switch, Resistors, Condensers, Instructions **\$16.95**

RECEIVER KIT: 27 1/2 Mc. AC/DC sens., Relay, Tubes, Wound Coils, Drilled Chassis, Resistors, Condensers, Instructions **10.95**

3,000 VOLT MULTITESTER

AC: 0-15, 150, 750, 3000 volts.
 DC: 0-15, 75, 300, 750, 3000 volts.
 DC MA: 0-15, 150, 750 ma.
 Resistance: 0-10,000, 100,000 ohms.
 Complete with battery, test leads. Only 2 1/2" x 4 1/4" x 1 3/4". Brand new.

Only **\$9.95**



TRANSMITTER & RECEIVER KIT—27.255 Mc. Band. License Free. For Model Planes, Boats, Cars, Toys. All parts & diagrams (less tubes & crystal) to build 5 Watt Transmitter Unit & 2-Tube Lightweight Receiver, including SIGMA 10,000 ohm Relay. **\$9.95**

SIGMA 4F RELAY, 8,000 ohm. 1 Ma. 4.95-3000 ohm. \$8.95

STORAGE BATTERIES—2 Volt. 3"x4"x1 1/2"—27 A. Hr. 2.75

MINIATURE 6 Volt-Willard NT6—2 1/2"x1 3/4"x3 1/2" 2.45

1 1/2 VOLT TINY MOTOR, 6,000 RPM with double shaft. 1.95

ABOVE MOTOR with VARIABLE SPEED GEARBOX. 3.95

GEARBOX, 800/1, 2 1/2"x2", 5,000 RPM. 1.48

TOY ELECTRIC MOTOR KIT. Special 1.30

GROUND PLANE ANTENNAS, 10-20-40 Meters: easily made with our painted copper-plated WHEES—threaded tapered sections: 16 ft. \$3.95; 32 ft. \$6.95

METERS: 2": 0-1 Ma. \$3.75; 0-3 Ma. 2.95

MULTIMETER KIT: Basic parts to build (less case) 3 Ma. 0, 60, 600 Volts & Continuity. Includes meter. 3.15

RF PROBE KIT: For Scope, Sig. Tracer, VTVM. 2.45

G.E. BLNKY CONTR. UNIT—switch sens. 10,000 ohm relay. 1.25

6 VOLT DYNAMOTOR—300 V. @ 100 Ma. 9.50

New! 6 V. VIBRATOR SUPPLY, only 3 1/2" x 1 3/4" x 4 1/4", delivers 135 V. @ 30 Ma.; 1 1/2 V. @ 300 Ma. operates from NT8 Battery. NOT A KIT **\$5.95**

Clockwork ELECTRIC TIMER: 1/2 to 24 min. \$1.00

GENERATOR: 12-24V DC, 13 amps. Requires 1/8 h.p. or larger motor with pulleys. \$5.25

TOY TRAIN TRANSF: 18V 2A \$1.65; 4A \$4.95

RECTIFIERS: 18V 1A \$1.40; 2A \$2.10; 4A 3.75

2 V. VIBRATOR SUPPLY KIT: 180 V./35 Ma. \$6.95

2 V. BATTERY CHARGER KIT: \$4.95; wired \$6.95

ALL MATERIAL GUARANTEED—FREE CATALOG "B"

GYRO ELECTRONICS 325 Canal Street
 WORTH 6-1290 New York 13, New York

be somewhere between 3 and 7 mmf. The exact value depends upon circuit physical conditions of the individual chassis layout.

Our model contains a fixed 3.3 mmf. ceramic coupler, but the constructor is urged to use a Erie NPO Ceramicon Trimmer #557 with a variable capacity of 3 to 12 mmf. Adjust both the screw of the coupler and ferrite tuning coil slug with a plastic blade screwdriver, or one whittled from a hardwood dowel.

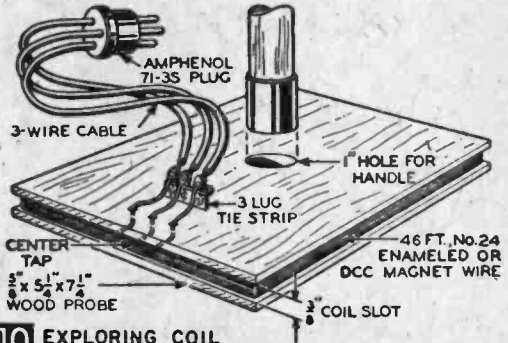

10 EXPLORING COIL

You may spend an hour or so adjusting your metal locator, but once it is adjusted to maximum sensitivity it will require no further attention. Note that the exploring coil is sensitive only to metal. Many devices of this type "act up" when the bare hand is passed across the coil. On this one, however, there is practically no body capacity effect unless you actually grasp the edge of the coil or chassis with the hands.

A single 1000 ohm Alnico magnet headphone provides ample volume. Both oscillator and receptor tubes are 1T4 pentodes. Once in a while a 1T4 may not oscillate at full efficiency. Try switching the tubes around once the locator is working for a stronger and more sensitive signal. Finally, a word about the B voltage. The receptor portion of the circuit performs very well on just 22 1/2 volts. However, the oscillator requires more voltage. If the device does not oscillate on 30 volts, add a 15 volt Eveready No. 411 or 411E in series with the 30 volt battery to raise the plate voltage to 45. Two 22 1/2 volt 412 or 412E cells also may be wired in series to provide 45 volts if required.—END

Speaker Repair Hint

• Distortion in an old speaker may be due to an off-center voice coil that could be reset. Turn receiver on and volume up to cause distortion. Press lightly on rear of speaker cone in several spots and note if condition is remedied where you press. By applying speaker cement to a suitable thickness of sponge rubber (obtainable from inside of an old vibrator) between speaker cone and bracket of speaker frame in spot where distortion is cleared up by pressure, you may make a suitable repair.—WM. MUESSIG, JR.

Fig. 1. Multi-purpose detectophone, shown here on duty as a baby tender and night light, is housed in a replacement type radio cabinet. Original dial opening is fitted with colorful decal, illuminated by 7-watt, 155-volt Mazda lamp (see Fig. 2).

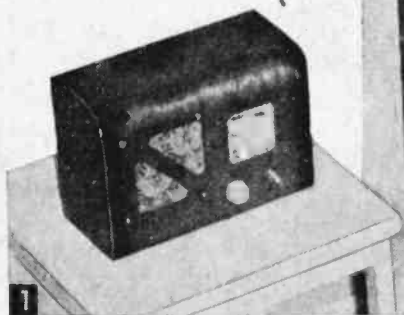

Wireless Electronic Detectophone

It looks like a radio, but this novel gadget is a "private ear" which picks up and broadcasts remote conversations through any conventional home receiver

By THOMAS A. BLANCHARD

USED with any radio receiver, this detectophone performs as home broadcaster for parties, an intercom and a remote baby-tender (as in Fig. 1). It also serves as a novel nursery night light.

The circuit consists of a stage of pre-amplification feeding a grid-modulated Hartley type

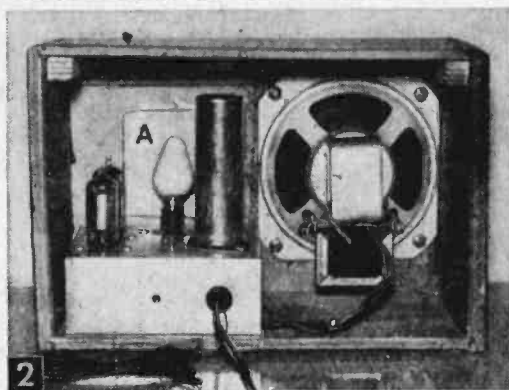
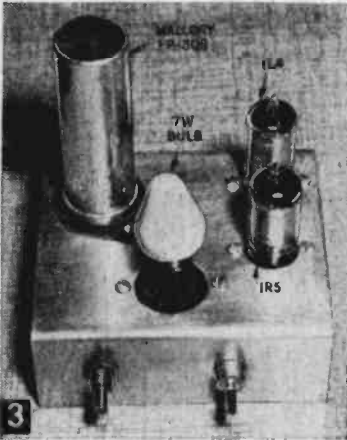

Fig. 2. Half of the cabinet is occupied by chassis, while the remaining space provides for mounting a 5-in. PM radio speaker which functions as a very sensitive dynamic mike. Dial opening at A has been covered by decal through which bulb shines as night light.

oscillator (Fig. 5). An ordinary radio PM speaker is used as a dynamic mike; it is not only cheaper, but more sensitive than many much more expensive crystal mikes, because of the larger diaphragm of the speaker.

The interesting circuit arrangement provides a power consumption of only about 10 watts and unlike other power-line operated devices, you need no warm-up period for the tubes. While the detectophone operates from the 115-volt power line, it employs miniature battery type tubes. The A-voltage for their filaments is provided by the same selenium-rectified power



3 This chassis was formed from #14 aluminum to measure 4 x 3½ x 1½ in. but you vary design and size to suit.

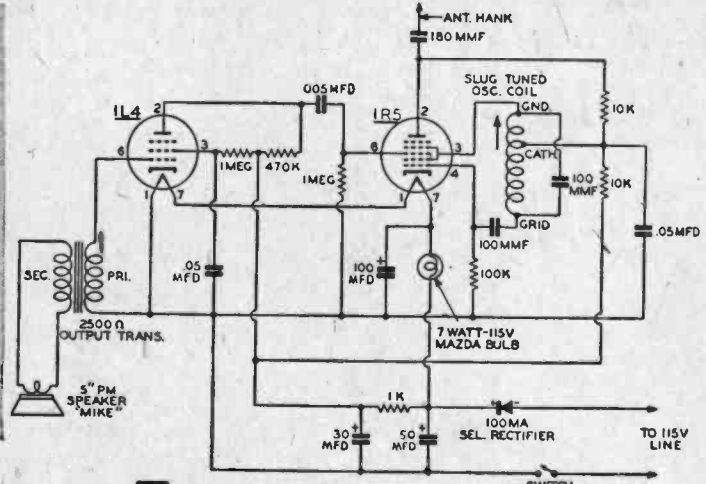

4 SCHEMATIC DIAGRAM

supply as is used to furnish the unit's B-voltages.

To drop the rectified line voltage to 3 volts as required for the series wired 1L4 and 1R5 7-pin miniature tubes, a Mazda #C-7 115 v. indoor Christmas tree lamp is used as a voltage drop resistor. These candelabra-base bulbs are also used in plug-in night lights and they are available at hardware and variety stores. You can use a colored lamp (instead of a white or clear) if the light is too bright.

The original chassis we used was bent from a piece of #14 gage aluminum measuring 6½ by 4 in. The ends of the panel were bent 1½ in. from each end to form a C-shaped 4 x 3½ x 1½-in. design on which the components are mounted. This size fits a small replacement cabinet supply 5-in. PM speaker, obtained from a radio supply house. Drill two ⅝-*dia.* holes in the chassis for mounting the miniature tube sockets, a 1⅝-*dia.* hole for mounting the electrolytic capacitor, and another hole sized to match the miniature Mazda lamp socket.

Although we mounted a candelabra socket shell on a wafer salvaged from an octal base tube socket, there are regular cleat sockets available from electrical supply houses. Or a socket from a discarded tree lighting string may be force-fitted into a suitable hole drilled in the chassis.

On the front apron of the chassis, drill a ⅜-*in.* hole and ⅛-*in.* hole for mounting a rotary line switch and snap-in Hartley type radio oscillator coil. On the rear apron drill a ⅜-*in.* hole in the chassis for passing the line cord and short antenna lead. Fit this cord hole with a ⅜-*in.* rubber grommet to protect line cord from damage.

Now mount the various components that screw down, including the 100 MA selenium rectifier, which is secured to the rear chassis apron with a 1-*in.* 4-40 *rh* screw.

If you follow the general layout shown, very

MATERIALS LIST—DETECTOPHONE

- 1 piece #14 aluminum for chassis, 6½ x 4 in.
- 1 midget radio replacement cabinet (or homemade case)
- 1 100 MA selenium rectifier
- 1 5 in. PM speaker
- 1 audio output transformer for above (Stancor #A-3849 or 50L6 type)
- 2 7-pin miniature wafer or molded tube sockets
- 1 1L4 battery radio tube
- 1 1R5 battery radio tube
- 1 Hartley-type radio oscillator coil with tuning slug (Stanwyck #212 (or similar), Stanwyck Winding Co., Newburgh, N. Y.)
- 1 GE Mazda #C-7 115 v. bulb. (In areas where line voltage runs high or is poorly regulated use a 6 watt clear lamp GE #C-6 sold by electrical supply houses)
- 1 candelabra socket for above
- 1 rotary type line switch
- 1 line cord and plug

CAPACITORS

- 2 .05 mfd. molded paper capacitors, 200 or higher working volts
- 1 .005 mfd. molded paper capacitors, 200 or higher working volts
- 2 100 mfd. mica or ceramic fixed capacitors
- 1 180 mfd. mica or ceramic fixed capacitors
- 1 triple section electrolytic capacitor (Mallory #FP-309) with 50 and 30 mfd. sections at 150 DC working volts, and 100 mfd. section at 25 DC working volts

RESISTORS

- 1 1K (1000) ohm 1-watt resistor
- 1 100K (100,000) ½-watt resistor
- 2 10K (10,000) ohm, ½-watt
- 1 470K (470,000) ½-watt
- 2 1 meg., ½-watt

little hook-up wire will be required since leads on components can be connected directly to their circuit terminations. However, it's wise to slip spaghetti insulation over bare capacitor and resistor pigtailed to prevent short circuits. The triple section Mallory #FP-309 electrolytic capacitor is mounted on the plastic insulating wafer supplied by the manufacturer. The chassis is completely isolated from the ground side of the circuit making it shockproof. However, a protective paper sleeve should cover the electrolytic can (if not included with your capacitor) since the can is common to the ground.



Built into a pen case, this little self-powered radio requires no outside antenna. Stations are received by attaching clip lead to telephone dial screen, or other metal.

A DISCARDED ball point pen barrel holds this radio that not only makes a conversation piece, but really works—and works well! A tuning knob in the cap selects various local stations.

A crystal set, it uses a germanium diode detector and requires no operating power. A flexible clip lead attached to a phone dial finger stop, or other handy metallic object becomes an antenna for picking up local stations. X-type antennas may increase the set's range to 50 miles.

The pointed plastic tip of a dime store pen carrying the ball point and capillary ink tube is discarded, leaving an open barrel. Drill $\frac{1}{8}$ -in. hole in the bottom of the barrel for the phone cord and flexible antenna lead.

Drill a $\frac{3}{32}$ -in. hole in the top of the pen cap to complete preparation of the pen barrel. The tuning coil is the next job. The coil shown in Fig. 2 consists of 12 ft Litz coil wire lattice-wound on a paper-base Bakelite tube $\frac{1}{4}$ in. I.D. x 1 in. long. Leave coil leads long enough to be connected to the other components.

Duco or similar cement is applied to the outside of the coil before inserting it into the pen

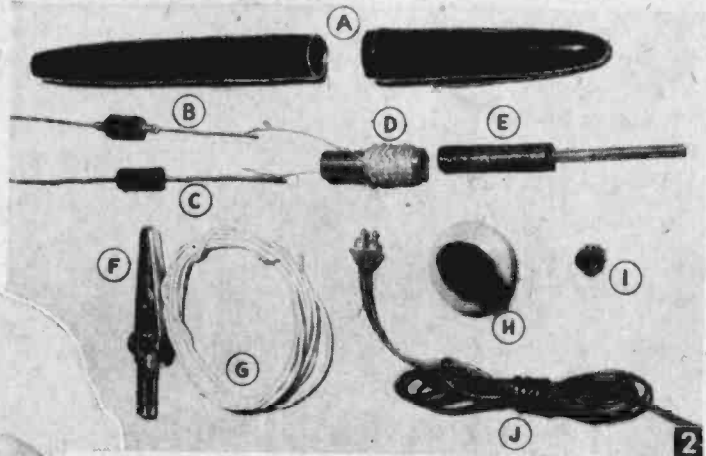

Component layout—A. Pen cap and barrel. B. Diode detector. C. Ceramic fixed capacitor. D. Coil. E. Tuning slug and screw. F. Small alligator clip. G. Antenna lead. H. Earphone. I. Tuner knob. J. Earphone Cord.

Fountain Pen Radio

This "air-powered" set built in a pen case will receive stations up to as far as 50 miles away

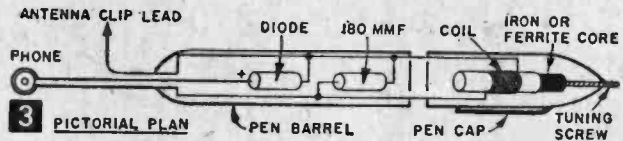

3 PICTORIAL PLAN

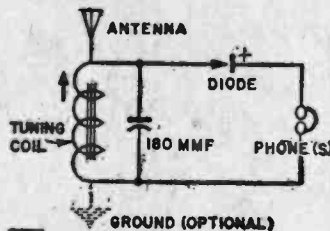

4 SCHEMATIC PLAN

cap. The tuning slug is received a suitable slug and coil form to wind the Litz wire on. Or you can purchase a ferrite-tuned radio antenna coil and strip off its outer cardboard cover and trim the lugs to get it into the pen barrel.

Many inexpensive and surplus radio or TV I.F. transformers will yield a suitable slug and coil form to wind the Litz wire on. Or you can purchase a ferrite-tuned radio antenna coil and strip off its outer cardboard cover and trim the lugs to get it into the pen barrel.

The 180-mmf fixed ceramic capacitor and diode detector will fit nicely into the pen barrel when arranged as shown in Fig. 3. Be sure "pigtail" leads are covered with radio spaghetti or plastic Scotch tape so that leads do not short when inserted in pen.

The total cost of this novel radio is about \$3, less the button type hearing aid receiver. A high resistance magnetic unit of this type costs about

MATERIALS LIST—FOUNTAIN PEN RADIO

- 1 cheapest grade ball point pen, or discarded fountain pen
- 1 tuning coil (available from Electro-Mite, Box 636, Springdale, Conn. for \$1, or a complete kit except earphones for \$3, postpaid)
- 1 small spool Litz wire (for homemade coil only)
- 1 short length insulated antenna lead wire (plastic stranded)
- 1 alligator clip (small)
- 1 germanium diode detector (CK705, 1N48 or 1N34)
- 1 high resistance hearing aid receiver, or standard size Alnico radio headphone (1000, 1500 or 2000 ohms)
- 1 180 mmf fixed ceramic capacitor for local stations between 1400 and 660 kc. Beyond 660 use 250 mmf, below 1400 kc use 75 mmf.

\$8. However, a standard radio type Alnico headphone costs a fraction of this figure. Except for its size, it far outperforms a hearing aid receiver

in volume. In either case, headphone leads and flexible antenna wire are fished through the 1/8-in. hole and soldered in place, along with the two flexible coil leads. The pen barrel is now slid up the cord to enclose the components and engage the cap.

The cap makes a tight friction fit over the barrel. While there is little danger of the radio pulling apart, a drop of cement may be applied inside the cap to permanently secure it to barrel.

Turning the #4-40 screw on the tuning core proved a little rough on the fingertips, so I squirted a generous amount of Duco cement into the plastic cap salvaged from a discarded lighter fluid can and attached it to the screw, allowing screw and knob to dry overnight.

Small-Fry Television Silencer

THE small-fry TV programs need not be an annoyance to adults, if a simple provision is made for plugging in a headset. A youngster can watch and listen to the sound through headphones without bothering others in the room. The only materials required are a pair of magnetic (wire-wound) headphones and a closed circuit phone jack for most TV sets.

With only two wires connecting to a permanent magnet (PM) type speaker, follow the diagram in Fig. 2. Disconnect one of the two leads near the speaker and connect an additional length of wire to the speaker terminal. The remaining ends of these two wires connect to phone jack. If the jack is correctly connected, the television set should function normally if the phones are not connected. Plugging in the headphones should silence the speaker and the signal should be heard in the headphones.

Although it will work either way, if you prefer that the phones not be in series with the speaker, use the alternate hookup shown in Fig. 2A.

Some TV sets in use today have four wires connecting to the speaker. On these sets one side of the power line cord is usually connected to the chassis and a shock hazard will exist if one side of the speaker voice coil is connected to the chassis. For this type of set connect the phone jack as shown in Fig. 3.

If there is any doubt about how your TV set's speaker is wired use the diagram shown in Fig. 3. It is absolutely safe regardless of the type of speaker. The jack can be fitted into a 3/8" hole in the TV cabinet, or secured to the back with a small angle bracket. The connections and the rear of the phone jack should be covered or else the jack installed so

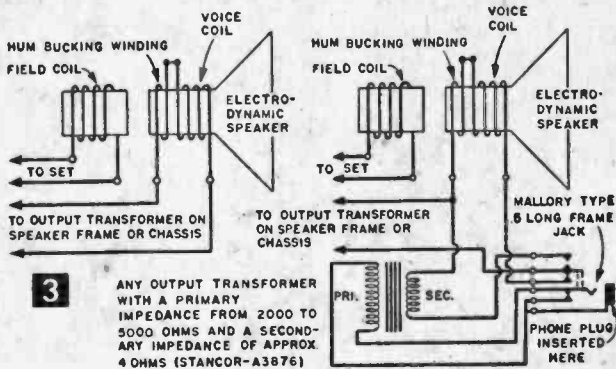
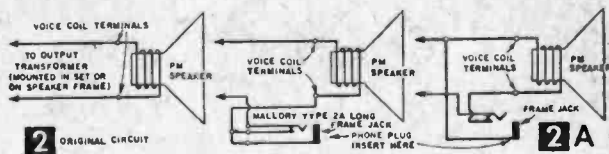
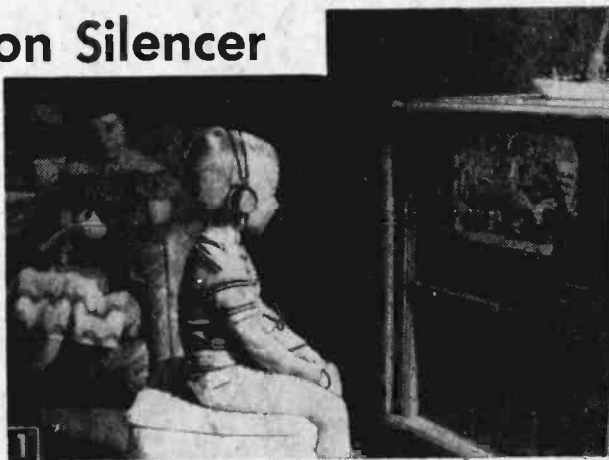

the back of the jack is not exposed.

Voltages involved are entirely harmless, so Junior can do his own plugging in without danger to himself or the set. All switching is accomplished automatically.—ELBERT ROBBERTSON.

Twin Speakers Improve Fidelity

IF YOU have twin 6' or 8 in. P.M. type speakers, it's an easy job to connect them in series at their voice coils, and their combined performance will sound very much like one expensive speaker of twice the diameter. The two-speaker combination will, in fact, reproduce any audio signal with less distortion. Costwise, the two small 6 in. P.M. speakers cost about the same as one large 12 in. speaker.

To connect the small speakers in series, first mount them on a single baffle of suitable size (preferably of $\frac{1}{2}$ in. insulating board).

The important thing to consider when connecting the voice coils is their correct polarity with respect to the operation of the cones. They must work in phase, that is, both cones must be pulled in and pushed out together, on each impulse of the signal, or vibrate together, rather than have one pull in and the other push out. To do this, use a flashlight cell and 2 clip leads to test the operation of each cone (Fig. 1). With the positive, (top of cell) connected to a certain voice coil terminal, the cone will be pulled in. If you reverse the battery polarity, the cone will be pushed out. Mark the terminal used when the cone is pulled in with positive polarity on that terminal. Do the same thing to the other speaker. It is now a simple job to connect the two voice coils in series (Figs. 2 and 3), connecting a positive to a negative. Solder on long leads for connection to the output transformer. Then double-check by attaching the battery to the long leads, and make sure that both cones pull in and push out together, with a reversal of the battery leads. The two speakers will now operate as a single unit, each taking half the power output, which doubles the capacity of a single speaker of the same size.

For good bass reception, speakers should have a rather flexible cone mounting, since bass is at the lower frequencies where the maximum cone movement is evident. Many speakers will be found with very stiff working cones, easily determined by gently pushing in at the center with a finger. Such speakers work all right at the higher frequencies, but may lack good bass re-

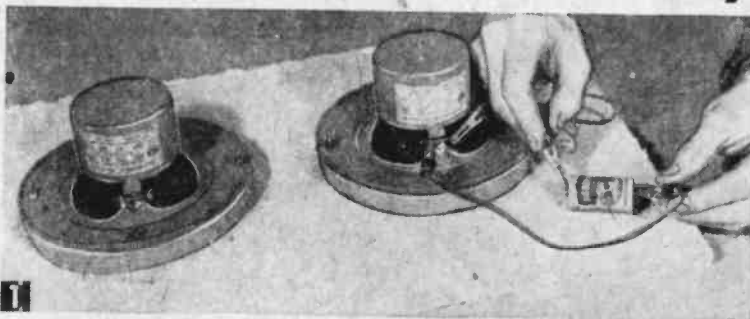

1

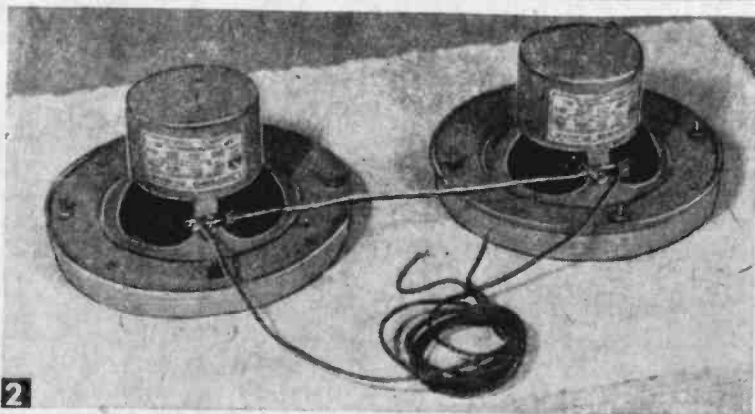

2

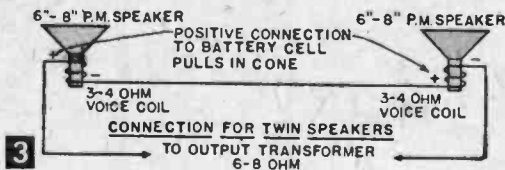

3

sponse. In the past, speakers were made with a flexible leather mounting ring at the edges of the cone to improve the bass. The two shown in Figs. 1 and 2 have bellows-like construction at the edge, rather than the usual direct mounting to the frame, to provide a more flexible operation of the cones.

For good fidelity choose a good quality output transformer of generous size, since a cheap, small transformer will often fail to cover the wide frequency band of the signals delivered to it, if the full range of the musical scale is desired. The transformer must also match the rated load resistance of the amplifier output tube or tubes in the circuit, to the voice coil impedance. For example, a 6V6 with 250 volts on the plate requires 5000 ohms load resistance. Using the twin speakers, each with a 3-4 ohm voice coil, this becomes 6-8 ohms in series. Thus, you must match 5000 ohms to 6-8 ohms on the secondary of the transformer.—HAROLD P. STRAND.

Simplifying Television Repairs

By THOMAS A. BLANCHARD



Fig. 1. Occasionally, adjustment of tuner oscillator coil slugs will restore picture sharpness. To reach slugs, pull off station and fine tuning knobs. Fig. 1A. Coil boards on turret tuners may be snapped out of drum for replacing with a UHF channel. Clean silver buttons with Carbona occasionally to remove leakage paths caused by dust and minute metal particles.

SOME troubles that plague TV sets call for complex test equipment and special knowledge that only a professional serviceman can afford. But anyone with a good working knowledge of radio can remedy many simple ailments that develop within his TV set—if he has the necessary information on his set, and follows the trouble guide we are about to present.

A trouble guide, alone, is like a man who buys a safe but doesn't get the combination to open it. TV sets purchased from a mail-order house usually include technical data and chassis tube arrangement packed with the set. But many sets are sold that seldom contain anything more than a small operating booklet and the chassis tube layout glued or tacked inside the cabinet or on the bottom.

To tackle any servicing, you will need to have handy: (1) The schematic and

chassis arrangement diagram, plus all the service data for your set. (2) A complete replacement set of tubes for your set to be kept on hand for the time when one or more tubes are needed. (3) A radio tube manual.

Even when you are unable to cure the ailment in your TV set, or when you don't even want to tackle the work, being able to advise the serviceman where the trouble seems to be can save you real money. Also having complete service data on your set will save the serviceman a trip to his shop to get the circuit dope he needs to restore your set to operating condition.

How to Get Technical Data. Complete technical data with chassis photos (top and bottom views), schematic diagram, tube locations and function, and alignment data are sometimes available free from small TV set makers and mail-order merchandisers. Otherwise, you can obtain these technical data on just about any TV set ever made from either of two respected technical publishers listed below. These data are complete and were compiled by experts working with the engineering departments of the TV manufacturers. The

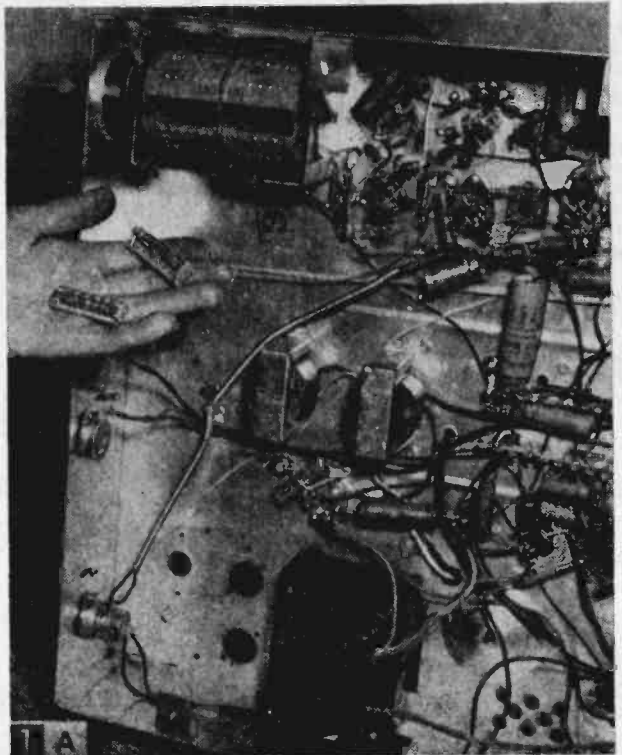

data for each make and model come in a separate packet modestly priced.

Before buying data for your set, obtain their free index and price list. Hundreds of sets of folders, trademarked "Photofact", are published by Howard W. Sams & Co., Inc., and are available through more than 1000 distributors of radio and TV parts in the U. S. and Canada or by mail from radio and TV parts suppliers. Another

series of folders, "Tek-File", is available from John F. Rider, Publisher, Inc., 480-B Canal St., New York 13, N. Y. Check your TV set's name-plate for model and serial number against the listing in the free index to be sure of getting the correct packet.

Before going ahead with servicing instructions using this TV trouble guide, you should remember these safety rules—(1) Do not touch or re-

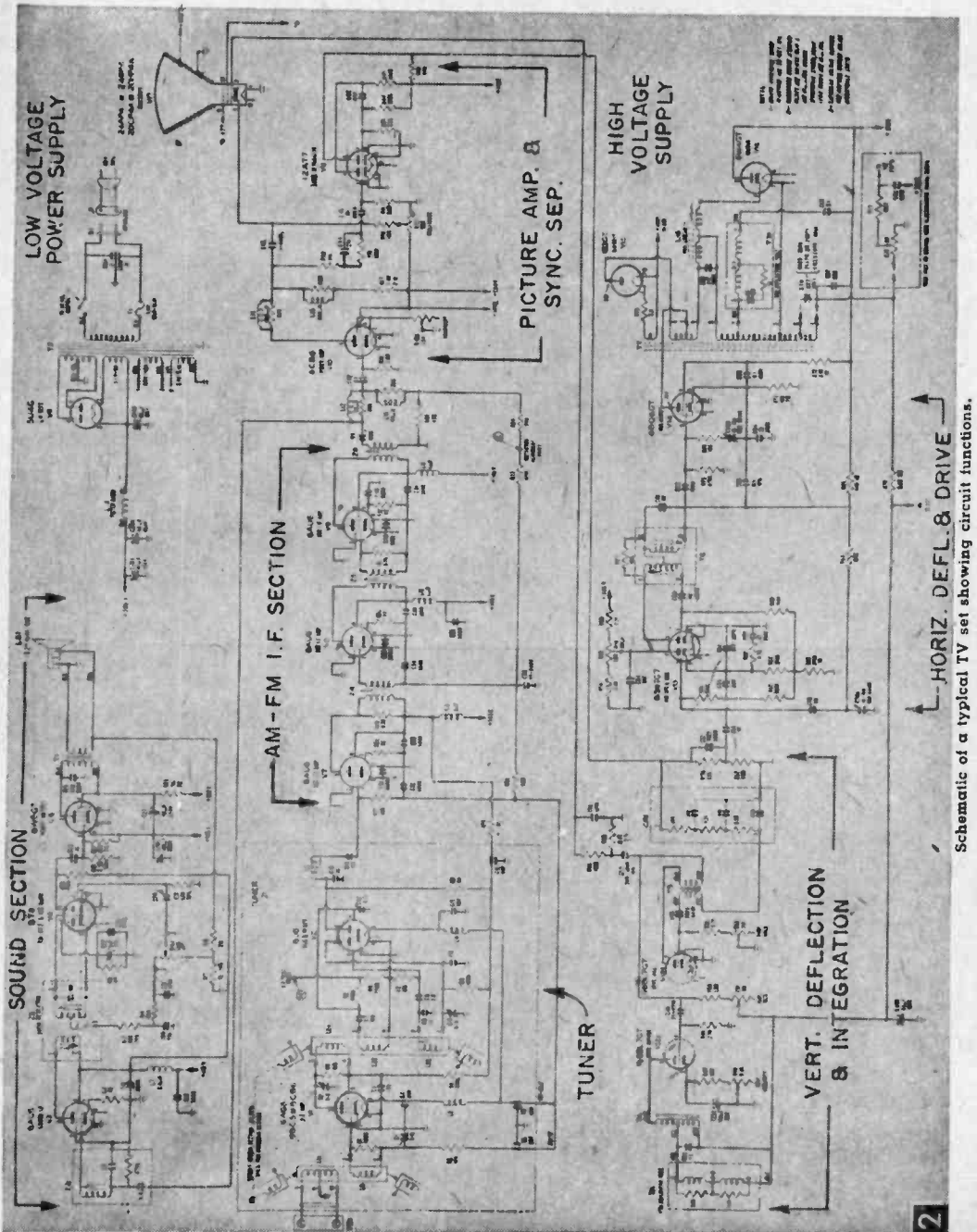

Schematic of a typical TV set showing circuit functions.

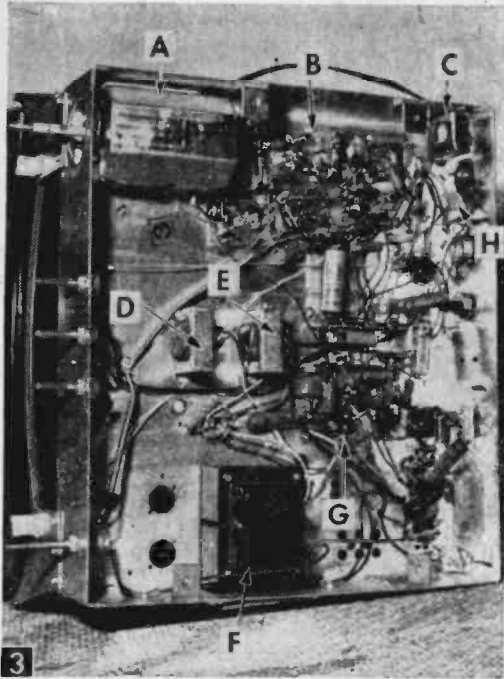

Bottom of typical TV chassis: (A) Turret Tuner. (B) Printed or Unit Type I.F. Strip. (C) Audio Output Transformer. (D) Low Voltage Filter Choke. (E) Vertical Output Transformer. (F) Low Voltage Power and Filament Transformer. (G) Low Voltage Filter Section. (H) Centralab PC-100 or 101 Printed Circuit Vertical Integrator Couplute.

move the high-tension cable at the side of picture tube when power is on. Before touching anything inside the high voltage cage, discharge the unit by grounding the caps of the H. V. rectifier and horizontal output tubes with an *insulated* screwdriver by touching the screwdriver blade from the tube caps to the chassis. (2) Do not use a "cheater" cord in order to operate set when the cover of H. V. cage is removed. This interlock was designed for your safety, nothing else! (3) Do not handle picture tubes by the neck and do not drop pliers or heavy tools on the picture tube. These tubes are exhausted of all air and external air pressure on the glass is terrific! When working on a chassis removed from the cabinet, wear safety glasses or cover tube with a light blanket to thwart damage of flying glass if it should break. (4) Never tamper with the slug screws on I. F. transformers (these are located atop the small aluminum cans near the I. F. tubes, or flush with chassis between I. F. tubes).

The best way to familiarize yourself with a TV set is to study the functions of each of its various circuits before trouble develops (Figs. 2 through 4). If you feel you need to review some of the basic elements of TV reception, study over the separate copy on "How a Television Set Works" accompanying this article. Also study carefully both the block diagram and chassis signal path charts you obtain for your set.

While the tube location chart pasted inside the cabinet indicates the type of tube in each of the various sockets, few charts specify the tube's circuit function. But you can observe with your eyes and ears and learn much about what happens when various tubes are removed from the chassis, and write these observations down for reference when the set actually develops some ailment.

Removal of any one tube from the R. F. amplifier in the tuner through to the video amplifier will result in loss of both sound and picture. However, the screen will remain illuminated. On the other hand, removal of tubes in the high voltage cage (Fig. 4) will cause the screen to darken, though the sound will remain normal.

Between these extreme ends of the TV circuit, we have the FM sound circuit, and the picture Synchro circuits (Fig. 2). Tube failure in the sound circuit will not affect your picture. Failure of the Synchro Separator, vertical output-oscillator, or horizontal AFC-oscillator tubes will darken the screen or produce a thin horizontal or vertical line of great brilliance on the screen.

To reduce the number of tubes in a given circuit, most set manufacturers employ several tubes with dual elements. These are known as twin triodes. The FM detector and 1st audio amplifier are often combined, as is the vertical output and oscillator, and horizontal AFC and output. The oscillator and mixer in the TV tuner is usually a twin triode. Thus a set that might appear to be an 18-tube receiver is actually a 22-tube set.

Here a word about voltage is important. The TV set requires B voltages of 145 d-c in the tuner, I. F. and FM sound circuits. Operation of the picture circuits requires 250 to 300 d-c volts. These voltages are no higher than those applied in high quality radio and hi-fi systems. However, in order to make the TV screen fluoresce, voltages from 10,000 to 20,000 are generated by a radio frequency oscillator signal, which is amplified and fed through the horizontal output transformer to the horizontal deflection coils on the neck of the picture tube. At the same time, part of this a-c signal is passed through a half-wave rectifier and simple filter circuit, to provide the high potential d-c for the cathode ray tube's second anode (the button connection on the side of the picture tube).

The purpose of the perforated metal cage (E in Fig. 4) to enclose the horizontal output tube, high voltage rectifier tube, and horizontal output transformer (or flyback as it is often called) is twofold: First, the cover shields the oscillator so as to prevent as much as possible its signals from radiating. Second, both the tube caps of the oscillator and rectifier tubes carry voltages that are dangerous.

While it is amperage and not voltage that is lethal, and since the high TV potential is only a few microamperes, the danger is in human reflex action. The sudden jolt could stop an ailing

heart, or cause a hale and hearty fellow to crash a pair of pliers through the picture tube with the resulting implosion and flying glass causing serious lacerations and even loss of sight (Fig. 5).

Always remember that if the TV screen is illuminated, there is no need to remove the cover from the high voltage compartment. And when the set is under power with the cover off, you can look, but don't touch—anything.

Since the voltage on the picture tube is so high that it cannot be measured with conventional instruments, servicemen sometimes use a simple neon indicator probe. This is nothing but a tiny NE-2 glow lamp with pigtail leads in lieu of a base. Tape the lamp to the end of a plastic knitting needle, or force it into the end of a piece of plastic tubing (B in Fig. 6) and you have an excellent probe.

As the probe is moved toward the caps of the horizontal output tube (Fig. 7) high voltage rectifier, and flyback transformer, the neon lamp will glow brightly, though not connected in any way to the circuit. If the lamp glows when held near the cap of the oscillator tube, but yields only a faint glow when placed near the wire leading to the button on the side of the picture tube, the indication is that the high voltage rectifier tube is defective.

While all other TV tubes (except metal types) glow, a perfectly good high voltage rectifier may appear to be out. Sometimes a pale cherry-red glow will be noted near the base of the tube when viewed in semi-darkness. Ordinarily, you

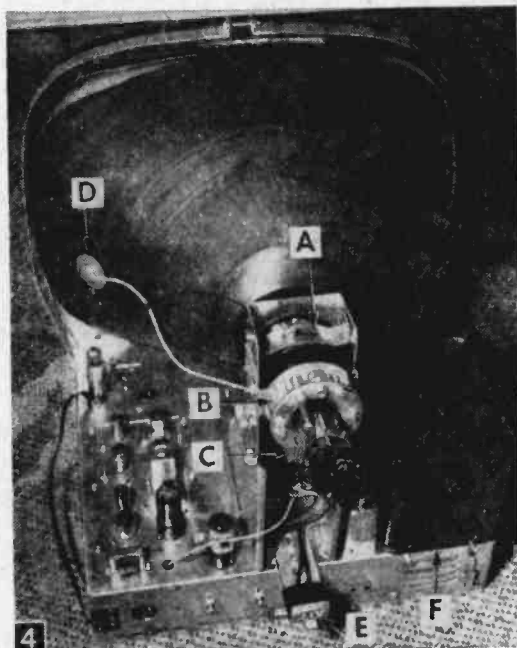

Chassis layout of modern TV set: (A) Horizontal and Vertical Deflection Yoke. (B) Focus Coil or Magnet (not on all sets). (C) Ion Trap Magnet. (D) High Voltage 2nd Anode Button. (E) Line Interlock Receptacle. (F) High Voltage Cage.

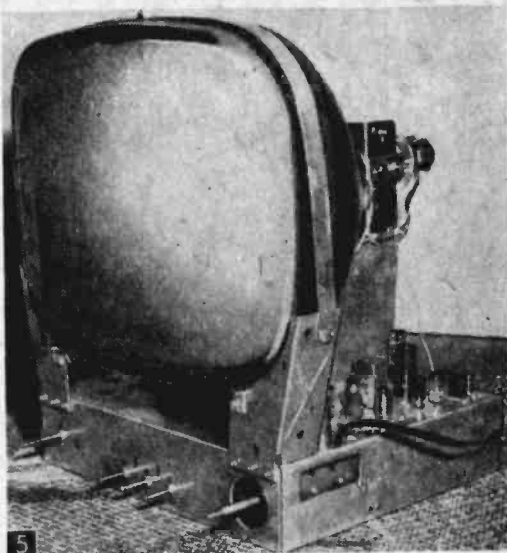

Modern TV chassis is amazingly light compared to earlier counterparts. Wear safety goggles when removing from cabinet, and avoid scratching tube face or dropping carelessly handled tools by covering with a small folded blanket.

will not notice the filament glow.

In some instances the flyback transformer will break down. When horizontal oscillator, output, H. V. rectifier and damper tubes are known to be good, but the neon glow lamp is not influenced when held near the transformer coil, it may be open or shorted.

Older TV sets were wired with a small fuse in series with the cathode of the damper tube. In some instances this fuse was clipped into a fuseholder. In other instances, it had pigtail leads for soldering directly into the circuit. Modern sets seldom use a damper fuse, although many contain a power line fuse. Both these fuses are similar in appearance to auto fuses. Failure of the damper fuse usually means a shorted tube in the high voltage cage, or defective flyback transformer. Sometimes the fuse itself may be faulty. Constant blowing of a power line fuse indicates a short most anywhere in the TV circuit.

The short may exist in the primary or secondary winding of the low voltage power transformer, shorted plates in the low voltage rectifier tube, or defects in other tubes. A shorted paper or electrolytic capacitor will also blow the line fuse in many instances.

Faulty tubes can be located by test. Defective capacitors of the paper type are usually oozing wax. A shorted metal-encased electrolytic capacitor will be warm to hot, or show a bulge when set is operated momentarily by shorting the fuse holder. Note the capacity and voltage rating printed on the defective component and replace with a new unit.

Poor Picture Reception. Let us assume that the TV set works, but poorly. In most instances, the

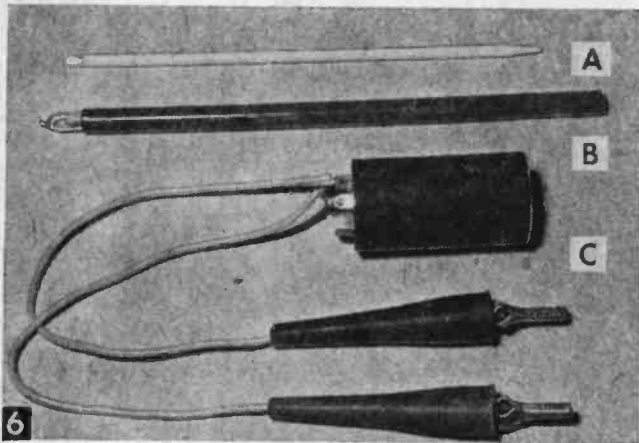

Simple TV repair tools: (A) Plastic alignment screwdriver fashioned by filing flat blade on a $\frac{3}{16}$ -in. dia. plastic knitting-crochet needle. (B) High voltage indicator is simply a NE-2 neon glow lamp fitted into end of 7-in. length of plastic tubing. (C) 40 mfd., 450-w.v. electrolytic capacitor fitted with insulated leads and test clips quickly locates open sections of filter capacitors in 145-300 low voltage power supply.

FM sound signal will pass through the tuner and I.F. strip and still be fairly good. The picture signals going through the same circuits will be virtually lost. Taking first things first, have you checked your antenna lately? Wind and sleet frequently cause one of the lead-in wires to break off. This may not greatly affect the sound, but it can result in a 50% loss in your picture.

The lead-in, itself, loses its efficiency after several years and may be attenuating the signals. Lead-in wire costs only a few cents a foot, a small investment for good reception.

A frequent cause of poor pictures and interference patterns can be remedied in seconds by realigning the oscillator slugs in the tuner (Fig. 1). This simple adjustment will also eliminate a-c buzz in many instances. Simply pull off the station selector knob as well as the "fine tuning" knob behind it (unless your set does not have one). Next, rotate the outer tuning shaft until a $\frac{1}{4}$ -in. hole is visible near the upper right-hand corner, on the front apron of the tuner chassis. The opening in your set cabinet is amply large for you to see this hole, using a penlite.

Beyond the hole you will note a large slotted brass screw of the headless type. There is a similar screw for each of the 12 channels on the turret tuner drum, each coming into view as the dial is rotated from 2 to 13. Some TV sets may employ selector switch tuners, in which case all 12 oscillator screws are visible at one time.

Starting with Channel 2 (or the lowest channel number in your area) turn the tuner to each station, and carefully turn the oscillator screw a trifle left or right with a plastic blade screwdriver until the picture is sharp and the buzz, if any, at a minimum. *Warning*—Oscillator screws are on a single thread spring wire feed. Turning the screw too far to the right will cause it to disengage from the spring. If this happens, the

coil board for that particular channel must be removed from the tuner drum in order to retrieve the tuning slug. To prevent this unnecessary labor, always turn slug screws first to the left and observe picture. If it gets worse then turn screw slowly to the right until sharpness results.

A metal screwdriver is useless when making adjustments in the tuner. You can easily make a plastic tool by filing a blade on the end of a dime store knitting or crochet needle (A in Fig. 6). The plastic blade will not chip or break because the tuning slugs turn without effort.

Having made the tuner adjustments, keep in mind that whenever you replace the oscillator-mixer tube it is often necessary to readjust the slugs, because of the slight variations in the internal capacitances within the tube.

Other common ailments are distorted, partially blacked or streaked pictures. Having had all tubes checked and found okay, do you hear any excessive hum coming from the loudspeaker when the volume is low? If so, one or more electrolytic capacitor sections may be open in the low voltage power supply.

Obtain a 40 mfd (or higher) single unit capacitor rated at 450 working volts. Solder insulated clip leads to its terminals so that it can be connected to the can (or common) lug of the electrolytic with the positive clip attached in turn to each of the positive lugs of the particular set capacitor being checked. Each aluminum can will contain 2, 3 or even 4 filter sections.

As the test capacitor is bridged across a section, note your picture. If the condition is corrected at one point, double check by removing the test capacitor. If the trouble comes back, then you know you have located the open section. Now simply solder a new single capacitor across the lugs of the defective multiple section unit. You don't need to replace the entire capacitor.

A more frequent capacitor failure occurs in the 100 mfd 200-w.v. unit filtering the low B voltage (145 approx.) which is usually taken off the cathode of the audio output tube. The screen grid of the audio output tube is fed by the full 280 or so volts that the power supply delivers. The audio output tube thus functions as an amplifier and voltage dropper without using power-consuming resistors. In some instances, poor pictures disappear when this seemingly unrelated audio tube is replaced with a new one.

Always allow a test capacitor to discharge through a 10,000-ohm resistor between each test. Capacitors hold their charge quite awhile and can produce a mule kick even though not connected into a circuit. More important, a capacitor just tested on a 280-volt circuit, then shunted across a capacitor on a low voltage circuit of 50 volts

might blow what had been a good capacitor.

Not all electrolytic capacitors in a TV set are of the aluminum can, multiple-unit type. High capacity, low voltage units are usually individual tubular pigtail types. It is best to disconnect one side of these units from the circuit before clipping in the test unit if the unit is marked 50 w.v. or less.

While it would be utterly impossible to single out all TV ills and give suitable remedies, rolling pictures combined with horizontal sliding of the picture are common in newer sets. Whereas the older vertical integrator had been individual resistors and capacitors, it is now a small ceramic plate about the size of a long special issue postal stamp and $\frac{1}{16}$ in. thick (H in Fig. 3).

This printed circuit unit will be found under the chassis near the socket of the vertical output-oscillator tube. Note the number printed on it and obtain a replacement from your parts dealer. Do not clip out the old unit until a new one is ready to be soldered in place, since the three pigtail leads must be soldered to the correctly numbered points.

Germanium diodes (Fig. 8) are great little gadgets, having made possible the elimination of a vacuum tube video detector in all sets of recent manufacture. However, they can be little stinkers and frequently are. Remember that both picture and sound signals must pass through this unit although hidden away under the chassis.

The germanium diode will be found between the last I.F. tube and the video amp., or sound I.F. tubes. Replace with a 1N60 or any other number listed as a video detector diode. Hold a wad of damp cotton on the pigtails when soldering in the new unit so that heat is not transmitted inside the unit to the germanium wafer and its catwhisker contact. Also observe polarity. The cathode end of the unit is indicated as K, Cathode, or a black or white bar or band.

Sets with a bad diode video detector yield a very weak and snowy picture along with weak ragged sound much like a set when the antenna is disconnected or broken off. A loss of picture brightness can be expected after the set has been in use steadily for a year or so. However, there are other reasons for loss of brightness. When removing or replacing the cabinet back on the set, the spring-held magnet on the neck of the picture tube is the ion trap or beam bender. If not positioned by forward-back and left-right rotation to yield the brightest picture, an ion burn will develop on the face of the picture tube.

If your screen shows a dark spot near its center, the ion trap is or was out of adjustment at some time. There is nothing to do about the spot now, but you can prevent it from getting darker. First, if your set has a manual focus adjustment, always readjust the ion trap after sharpening the focus. Or check the position of the trap now to ascertain if it is correctly positioned. In all cases, turn down the brightness control as dimly as possible, then move the trap to yield the brightest picture. Once set at max-

imum brilliance, the brightness control may be turned up to its normal position.

Other causes of dim and shrunken pictures may be simply due to the low voltage rectifier having seen its day. There are now available heavy duty substitutes for the 5U4G employed in many TV sets. Another hard-pressed TV tube in newer sets is the 6BQ6GT horizontal output, and the 6SN7GT horizontal AFC and oscillator. These tubes have been given an additional suffix, or completely new number by the various tube makers. Regardless of the individual manufacturer's number, all of them interchange with the earlier types, so it is only necessary to ask your dealer for the long-life version of the old tube.

Because larger and brighter pictures have been the order of the day, the high voltage applied to picture tubes has jumped from the 7,000 of a few years ago to as much as 20,000 volts for black and white receivers and 26,000 for color sets. If the black and white picture tends to dim off at times, or reveal erratic streaks, this may indicate a breakdown of the wax insulation on the flyback transformer coils.

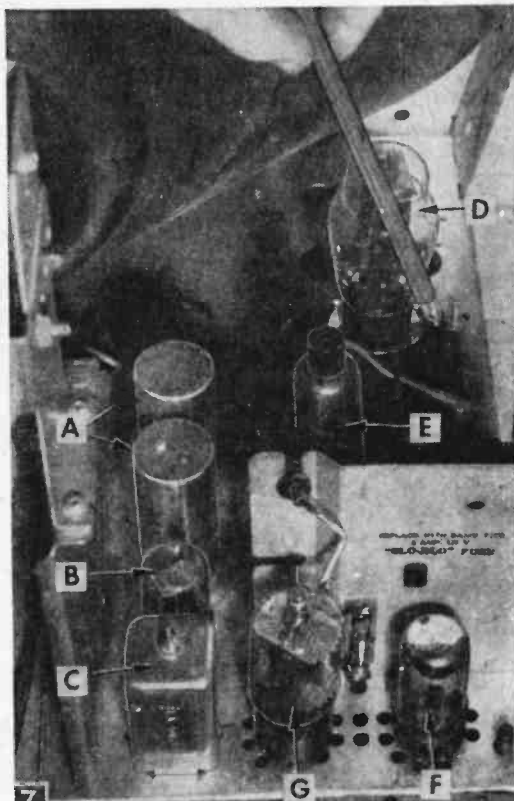

A—Filter Caps. B—Horiz. Osc. C—Osc. Coil. D—Low Volt Rect. E—Hi. Volt Rectifier. F—Damper. G—Hor. Output.

Low and high voltage circuits are usually grouped together. Determine if high voltage circuit is operating by holding glow lamp near H.V. trans. and caps of H.V. rectifier and horizontal output tubes. Never touch any component inside cage when, as here, cover has been removed.

Disconnect the set, remove the high voltage cage, apply power and allow the set to warm up. Observed in a darkened or dimly lighted room, insulation breakdowns will reveal miniature blue streaks of electricity dancing or jumping off the flyback coil. If this corona display takes place in your set, note down the points where it exists, but do not touch anything while the power is on. Disconnect the set. Special insulating waxes are available to seal off this arcing, but we have found that ordinary tailor's beeswax works fine. Dime store notions counters sell it at 10¢ a pack. Melt the wax with a soldering iron, allowing it to flow on the spots where arcing existed when set was on. Do not apply the iron to the wax already on the flyback coil; this could make the arcing worse.

One last word on the high voltage. Any TV tube with a top cap, whether or not it is in the high voltage cage, is dangerous. Some recent sets have the 1B3GT high voltage rectifier exposed, though fitted with a plastic insulated connector. Sets having bare metal clips on rectifier or horizontal output tube caps, should be made safe, after turning off the power, by touching the blade of a plastic handle screwdriver from tube caps to chassis so as to discharge the high voltage capacitor fully before removing either tube from set.

While it is generally safe to switch tubes in the tuner and I.F. sections while the power is turned on, damage can result when attempted in other parts of the circuit, not to mention burned fingers. Therefore, disconnect power, short caps of high voltage tubes to ground, and wear gloves to pull suspicious tubes. Some TV sets are ac-dc wired like small table radios. Filament failure in one tube causes several tubes to go out. All dark tubes must be tested in order to find the dud.

Picture Control Adjustments. Since all set manufacturers supply an instruction pamphlet describing the function of the various set controls, we will consider here only solutions to their erratic actions.

Volume and contrast controls receive hard useage as does the brightness control, except where it has been concealed behind the nameplate along with the horizontal and vertical hold controls. Except for variations in resistance, all TV controls are mechanically alike, even though they may have a ¼-in. long, short, knurled or slotted end. These potentiometers contain a plastic horseshoe on which has been deposited a carbon coating. A soldering lug riveted at each end of the horseshoe allows connection to the overall resistance. The shaft operates a metal slider which connects to the center lug on the control. As the shaft is rotated, the

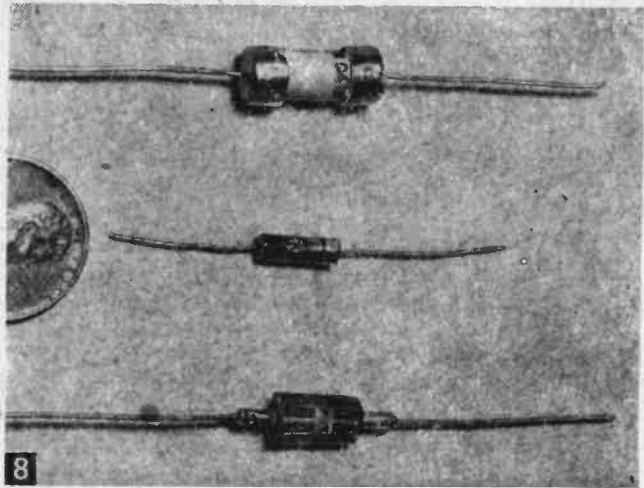

Partial or complete loss of pictures and sound when all tubes test good may be traced to defective germanium diode employed as video detector. Although they vary in size and shape, 1N60, CK706 and others marked "video det." are interchangeable.

slider wipes over the carbon surface providing a variable voltage divider.

Continuous use of the control wears down the carbon surface, resulting both in poor contact between slider and carbon element, as well as a change in the controls end-to-end resistance. In the case of the TV volume control, static-like sounds result when it is rotated. Once adjusted, the volume may fluctuate, and create the static sounds with each fluctuation.

A defective contrast control (Fig. 9) will cause horizontal picture streaks each time it is turned. If severely worn, these streaks may appear even when the control is stationary. In some instances speaker vibration is sufficient to jiggle the slider so that the lines will appear to rise and fall with a speaker's voice, or musical beat.

It is not uncommon to find a defective control in a circuit that is rarely adjusted. Pictures that flop over on their side and require frequent setting of the horizontal hold control may be corrected when the control is replaced. However, first check the adjustment of the slug screw on the horizontal oscillator coil. This coil may be mounted flush with the chassis or in a rectangular aluminum can. It will always be found near the horizontal AFC-oscillator tube or high voltage cage. Turning this screw slightly to the left or right may correct the flop-over.

When the TV picture shows over-all expansion or shrinkage on the screen, the cause is due to a defective tube or component in the high voltage supply. However, when there is only vertical expansion or contraction, creating people with egg heads or melon heads, either the vertical size or vertical linearity controls may be at fault. Since both controls interact, one must be adjusted against the other until a round target is obtained. If one control causes a rapid or erratic change in picture height with a mere

fractional movement of control shaft, it is most likely defective.

Your parts supplier has Mallory replacement controls to fit any make or model TV set. Dual controls are supplied unassembled so that any stacked unit with or without a line switch can be duplicated by the experimenter.

Focus controls of the potentiometer type are usually wire wound. This control rarely develops trouble, but where a carbon control is used, treat it with suspicion if it acts up.

While newer sets have the picture width fixed, some sets have a slug-tuned coil in the high voltage cage for this adjustment. Horizontal linearity is also a slug-tuned unit while a mica trimmer provides variable capacitance for horizontal drive and/or range. Except for infrequent adjustment of horizontal linearity, the other rear chassis apron controls should be left as they are.

Some of us are prone to turn anything that can be twisted with a screwdriver. Many set makers apply a dab of sealing wax or glyptol cement to the brass screws that adjust the I.F. transformers. These coils may be individually mounted in small aluminum cans, or flush mounted with just the brass screw visible on the chassis (Fig. 10). Never under any circumstances turn any I.F. screw, or any other screw dabbed with a securing agent. And cemented or not, do not turn any screw found near the I.F. stages unless you know its function.

Poor Sound Reception. Distortion and buzz in the FM sound circuit can be usually corrected by turning the recessed or exposed slug screw (Fig. 10) on top of the sound I.F. transformer (labeled either Ratio Detector or Discriminator). A slight turn to left or right will do the trick. The screw on this unit is not cemented.

Early TV sets employed separate I.F. strips for both picture and sound. In these sets, it is necessary to check tubes from 1st I.F. through to the audio output tube. In modern sets, you need look for audio trouble only from the sound take-off behind the video detector to the audio

output tube.

The most common cause of sound trouble is a defective tube. One of the little big things we overlook is that a tube that is lit can be just as much a dud as one that has burned out. In fact, the leading tube failure is the cathode-filament (heater) short, and such a shorted tube often tests okay when cool. In some instances the short will not develop until the tube has been in operation 15 minutes or more. In fact, it may be very intermittent, working normally for several hours, then quitting and coming back after a cooling cycle.

The purchase of a complete spare set of tubes to replace those now in your set should be done before trouble develops. If your set contains a number of tubes of the same type, you might purchase only half of this particular type, but buy two each of the hard-pressed types: low voltage rectifier, horizontal oscillator, and horizontal output.

Many mail-order parts suppliers offer name-brand tubes at very attractive prices, both on an individual and complete tube kit basis. Test the new tubes immediately by switching tubes one by one. Only if a new tube shows a great improvement over the old should it be left in the set. Save your new tubes until the time that they are really needed. Incidentally, there is no finer way to test a tube than this dynamic test in the actual equipment.

Note when switching tubes that three may require minor circuit adjustment: the tuner oscillator-mixer as mentioned earlier, the vertical output-oscillator tube may require resetting of vertical hold control, and the horizontal AFC-oscillator tube may require adjustment of the horizontal hold control.

Often a picture tube may develop a cathode-filament short rendering it useless. However, you can buy one of the deluxe type "picture tube brightener" devices with an isolated heater circuit which will restore the tube to normal operation within the set.

Returning to loss of sound, the paper coupling capacitor between the plate of the 1st audio tube and audio output tube may open. A broken lead in the speaker connector, or merely the connector plug not firmly sitting in the chassis socket will kill the sound. Loss of low B voltage through an open resistor will silence the audio circuit. Check, too, for open or shorted low voltage electrolytic capacitors such as are found in the plate circuit of the FM detector tube on certain sets.

Many TV failures are often of a very illusive nature—not surprising considering the great number of fixed resistors, capacitors, and tiny peaking and choke coils, etc., employed in the average circuit. Often a defective resistor can be spotted

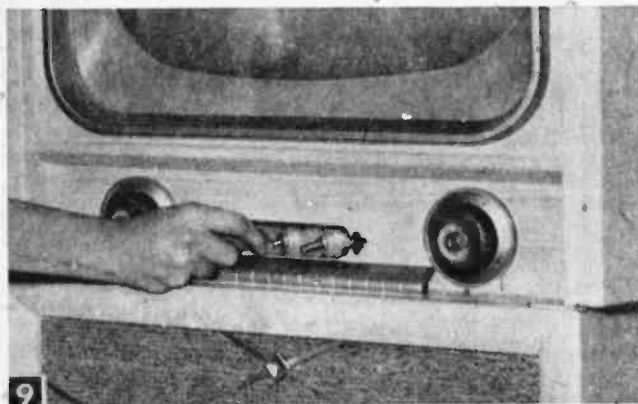

9 Frequent resetting of horizontal and vertical hold controls on front panel or behind nameplate, volume control grating, or contrast control may result in picture streaks usually denoting a defective potentiometer.

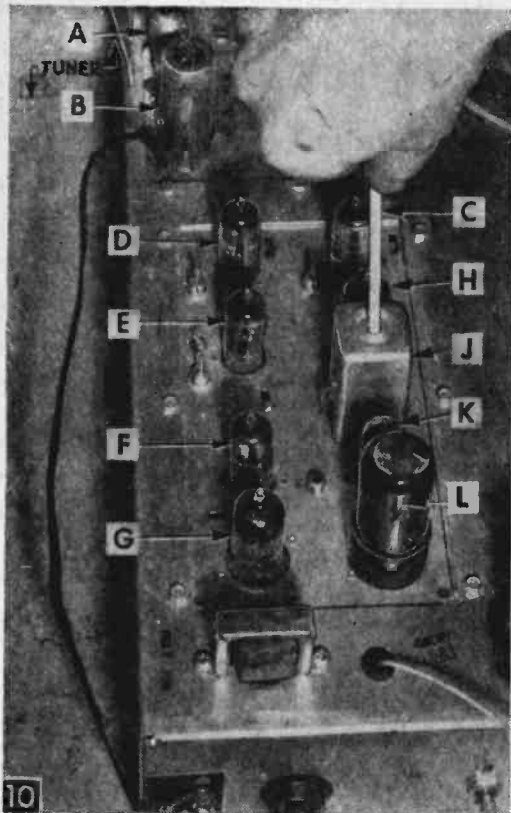

A—Osc.-Mixer Tuner. B—R. F. Amp. C—1st I.F. D—2nd I.F. E—3rd I.F. F—Video Amp. G—Sync. Sep. Amp. H—FM Det.-Amp. J—Ratio Det. or Disc Trans. K—Sound I.F. L—Audio Output.

A minute turn to left or right of disc, or ratio detector trans. slug will clear up hum or distortion in FM sound circuit. Never touch brass screws between I.F. tubes, or on tuner chassis.

by its charred appearance. A resistor of the same value, but double the old wattage, will restore reception except where the overload is caused by a short. This becomes easy to trace since it will be in the vicinity of the charred resistor in most instances.

Many capacitors in TV sets are of the disc ceramic type. Often one will develop a short, in particular the dual units with three instead of the usual two pigtail leads. Shut the set off after it has been running awhile. Feel each disc capacitor (they're about the size of a dime and $\frac{1}{16}$ or less thick). Replace any ceramic that is hot to the touch. If merely lukewarm, the unit is probably okay.

Gaining access to the under-chassis areas of the set does not require removing the unit from the cabinet. Most console sets are made with the chassis shelf open and covered with wire mesh (hardware cloth) or perforated Masonite to allow ample chassis ventilation. Removal of the protective screen provides easy and safe access to components.

Table sets may be turned on their side if the

chassis holding screws are firmly bolted to cabinet base. In both table and console sets, where full access is not available because of several small openings, enlarge to a single accessible entrance, then attach a suitable piece of hardware cloth over the large opening with wood screws and washers.

The latest TV sets employ a space-saving vertical chassis. Instead of controls being on the front of the cabinet, they are located on the side. The picture tube occupies the entire cabinet front. The chassis is located across the back of the cabinet with the neck of the picture tube projecting through the up-ended structure. Removal of the back panel on the cabinet reveals the "works", making ordinary repairs very easy to accomplish.

Even console sets feature this unorthodox chassis mounting with variations in that the chassis may be mounted vertically on the side of the cabinet, with dial belts linking the tuner to the knobs on the cabinet. Some sets have replaced the rotary channel knob with a slide-rule dial such as is found in auto radios. Even color TV sets resort to unusual chassis arrangements; frequently one in a vertical position for tuner, video I.F., sound I.F., etc., and related signal circuits, while the picture tube and its complex deflection circuits occupy a horizontal chassis.

When you are stumped, the only solution is to call in an expert service organization with men equipped with the knowledge to use signal generators, vacuum tube voltmeters and oscilloscopes in tracking down the bug in your set. However, an inexpensive battery-powered volt-ohm-milliammeter is within the range of most experimenters. And you'll find it useful to check such points as circuit continuity, and resistance values. Remember, however, that the key to even a minor set repair is that you have available a circuit diagram and operating notes on the particular set.

You may be able to obtain the manufacturer's Service Data Booklet by addressing a request to the Engineering Dept. of the company. We suggest you send along a quarter to cover postage and handling to indicate your good faith. Postcard requests are often ignored. When requesting service data, give the model and serial number located on the rear chassis apron. If you are unable to obtain data directly from the set manufacturer, many leading radio parts suppliers stock the Photofacts Service Data Folders we mentioned earlier. Each folder contains schematics, chassis layouts, and service notes on the set in question.—END

Soldering Kink

● Make soldering tip from a piece of drawn brass rod. Shape and form brass piece to fit; it does not corrode, will not deform, and does save time and gives a better job of soldering. It is slightly slower to heat than copper, but in spite of the difference in heating time you come out ahead with a brass tip.—A. P. BELANGER.

T. V. Trouble-Tracing Guide

TV screen dark except for horizontal white line thru center of screen.

Defective vertical sweep oscillator or amplifier tube, or both. Vertical height or size control improperly adjusted.

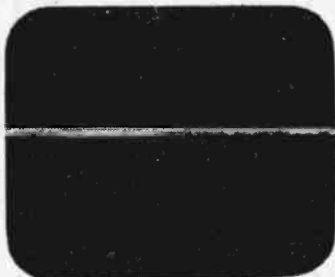

TV screen dark except for vertical white line thru center of screen.

Horizontal sweep circuit not functioning. Check horizontal oscillator and discharge tube, horizontal output and the damper tube. Width control may be out of adjustment or shorted.

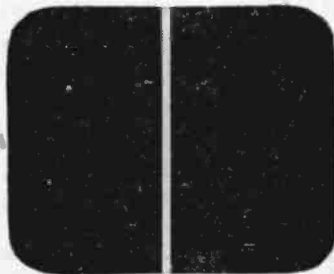

Picture too small. Screen dark around outside.

Check the low voltage rectifier tube. Deflection coil may be loose and not up against vortex of picture tube. If small pix is extremely bright, tube is receiving



excessively high voltage. Check all tubes in H.V. cage and look for defective damper resistor (large porcelain resistor located near damper tube.)

TV screen lit, no picture, sound okay.

Look for defective tube(s) in video amplifier, detector or video output stages. If set works on some stations, remove station selector knob and adjust oscillator slugs in turret tuner with plastic screwdriver. Adjust for best picture if intercarrier circuit—best sound for sets with separate sound and video I.F.'s.

TV screen lit, no picture, no sound.

Broken or disconnected antenna lead-in. Defective tube(s) in R.F. tuner, or in I.F. amplifier stages.

Picture tilted on screen.

Loosen wing-screw on deflection yoke and rotate coil right or left until pix is



straight. Keep yoke against picture tube or "neck shadows" may result. Retighten wing-screw.

Corner(s) of picture dark.

Usually due to yoke not being against vortex of picture tube. Also focus coil



and ion trap on picture tube neck incorrectly positioned will produce this condition. Readjust.

Partial picture. Top or bottom of screen dark; part of picture compressed or folded over.



Adjust vertical height and vertical linearity controls. If condition persists, look for defective vertical sweep oscillator or amplifier tube.

TV screen dark, no picture, no sound. If tubes in set are lit, look for bad low-voltage rectifier(s). Cherry glow on tube plates indicates short-circuit; usually a bad electrolytic capacitor. If tubes are out, check outlet or set's line fuse (if any) for absence of 115 v. If lit, check for loose speaker plug.

TV screen dark, no picture, sound okay.

Check H.V. rectifier, damper, horizontal oscillator, and horizontal output tubes for a burn-out or a neon-like glow. These in or near H.V. cage. Also check 1/4 amp. fuse located in damper circuit, and look for disconnected H.V. cable to button on side of picture tube (2nd anode.)

Narrow picture. Screen dark on each side.

Check for defective low-voltage rectifier tube, or horizontal oscillator tube. Also



check for improperly adjusted width control. Horizontal coil in deflection yoke may be defective. Check with neon lamp continuity tester.

Picture not centered on screen.

Horizontal and vertical centering or positioning controls require adjustment. If



set lacks these controls, center pix by adjusting the doughnut-like focus coil on neck of picture tube, or aluminum slip ring on deflection yoke. Then readjust the set's focus control, also ion trap magnet.

Squat picture. Screen dark top and bottom.

Vertical size control out of adjustment, vertical coil in deflection yoke may be



defective. Check and replace, if necessary, vertical sweep oscillator or amplifier tube, or both if defective.

Wide dark bars running across picture.

A defective tube in video I.F., detector or output stages. Tapping tubes with



pencil may reveal offender. Adjust sound discriminator screw. Check for defective contrast control.

Zig-Zag horizontal or diagonal lines through picture.

Adjust screw on automatic frequency control (AFC), centering and locking-in picture. Horizontal control knob on front of



set may cause this condition if "off center," or control itself may be "shot." Most likely, however, condition will clear up by inserting a new horizontal oscillator tube in set.

Picture lacks brightness.

Ion trap has slipped from its correct position on neck of tube. Rotate and slide forward and back on tube neck



until a bright, shadowless picture appears on screen. Magnet may have weakened; replace. Also check for defective horizontal output or high-voltage rectifier tube in H.V. cage.

Vertical "running water" streak down left side of picture.

Barkhausen-Kurz oscillations induced with horizontal output tube (6BQ6-G or 6BQ6-G.) Corrected by attaching a "Barkhausen Effect" magnetic suppressor to tube, or replacing tube if set has a built-in magnet attached to H.V. cover as in DuMont and some other sets. If trouble persists, replace damper tube.

Vertical wiggling lines through picture.

Often caused by a defective horizontal oscillator tube. If new tube does not help, try a wave trap on antenna lead-in as trouble may be a combination of a weak station and H.F. interference.

Thin horizontal lines across picture.

Make same tube checks as for wide, dark bars. Also check tubes in the R.F. tuner section by gently tapping, wiggling or replacement if condition persists.

Squashed pictures (horizontally).

Vertical peaking-linearity control must be adjusted in step with vertical size

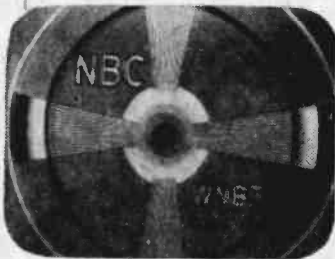

control. Readjust both to correct condition, using test pattern to insure symmetry. If trouble persists, check vertical sweep oscillator and amplifier tubes.

Stacked pictures, rolling up or down on screen.

Vertical "hold" or "lock" out of adjustment; turn until picture holds. If rolling



can't be checked, look for defective vertical sweep oscillator or amplifier tube or both.

Squashed pictures (vertically).

Horizontal drive or horizontal linearity control not adjusted in step with width control. Adjust both controls only when

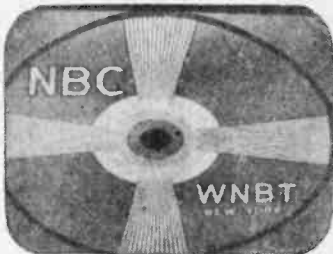

a test pattern is on screen to insure getting image symmetrical. If trouble persists, check horizontal oscillator tube, horizontal output tube and damper tube.

Torn picture; or the decapitated body.

Again the horizontal oscillator tube may be the culprit. First, however, be sure



the horizontal hold, automatic frequency or automatic gain controls are correctly set.

Harsh S-shaped or "fishbone" lines through picture.

Caused by either interference arriving at set with TV signal; X-ray, H.F. welders, FM stations, ham transmitters, etc. Try a wave trap in antenna circuit to remedy this condition.



Man-made interference frequently caused prior to June, 1952, by physicians' diathermy apparatus. Also by some X-ray, H.F. and resistance welding apparatus, electric furnaces, etc. Now outlawed by FCC, but old sets require new I.F. adjustment to prevent interference from this apparatus which is now working on FCC designated frequencies. If new I.F. adjustment is not perfect cure, insert suitable wave-trap in antenna lead-in. Use power line filter for welders, motors.

Weak snowy picture.

Usually this condition exists in the R.F. tuner section. Oscillator slug for a particular channel may have worked itself out of adjustment. Adjust with plastic screwdriver until brightest picture is clear and bright. Check all tuner tubes, and look for loose or broken antenna wires if slug adjustment fails to correct snowy pic-



ture. Video I.F., detector and output tubes or dirty turret tuner contacts may be source of trouble.

Shadow images.

Known as ghosts, these weaker signals are bounced off buildings and reach your set just behind the fundamental picture signals. Sometimes relocating the antenna will correct this condition if reflections are local. However, reflections may



originate near the TV transmitter and there is no cure unless TV station moves to a new location. And this has happened in several instances.

Picture blooms when brightness control is advanced.

Similar to above, but usually corrected when H.V. rectifier or horizontal output tube is replaced. May also be a signal of weak picture tube.

White and black streaks on picture.

Sewing machine, vacuum cleaner, hand-grinder and similar high-speed brush motors. Also caused by H.V. leakage explained under "blooming" pictures.



Keep H.V. cable to pix tube away from metal; remove dust from H.V. cage. Insert line filter if streaks caused by motors.

Picture good to fair, loud or medium hum in sound. No buzz.

Usually due to a defective electrolytic filter section(s) in low voltage power supply. Try a 40 mfd., 450 v. tubular electrolytic across each section of the can-type capacitors. Once defective section is located, just solder the unit permanently to the proper can lugs.

If hum is intermittent and flashes appear on the picture screen, it is likely that an electrolytic section is in process of shorting. Watch the low voltage rectifier tubes for sign of plates glowing a deep red, or neon-like glow around plates. Disconnect set at once to prevent further damage. Check sections of capacitors for the short. Clip this section out of circuit entirely and insert a single tubular replacement section of suitable capacity and working voltage.

On "intercarrier" sets, hum or buzz is often due to "contrast" control being turned too far to right. This is no sign of a circuit defect if the hum or buzz is eliminated when contrast is retarded.

Picture good to fair. Loud hum or buzz in sound.

If set is "intercarrier" type, adjust screw on primary of ratio detector transformer for maximum sound on a weak station. Now tune set to a strong station and adjust secondary slug screw on ratio detector transformer until buzz is either eliminated or minimized. If set is "separate sound," merely turn screw on discriminator to left or right until all hum or buzz vanishes. (See special notes on Tuner Adjustment.)

Picture blooms, or expands and contracts in size.

Check H.V. compartment visually for signs of purple arcing on cable to side of picture tube, or anywhere inside H.V. cage. Disconnect power and brush out all dust. Also check the 1 meg. 1/2 meg.



or 1/4 meg. H.V. filter resistor. Check horizontal output tube, damper resistor, damper tube, H.V. rectifier, and horizontal oscillator tube—all in or near H.V. cage.

Smallpox and liver spots.

Speckled screens, and permanent brown or yellow spot in center of screen calls for a new picture tube. If screen is speckled, the fluorescent coating has flaked due to age or poor manufacture. A brown spot is due to ion trap not being adjusted to give brightest picture; or set turned on without ion trap attached to neck of picture tube. Always keep brightness control at a very dim position when adjusting an ion trap. Turn up only after image is visible on screen.

Picture good, but no sound.

If set is known as "intercarrier" type, the presence of a good picture indicates the tuner, I.F. stages, high and low voltage supplies are okay. The trouble is in the 4 or 5 tubes in the sound section of circuit. A defective ratio detector driver, ratio detector, audio amplifier, or audio output tube is most likely the cause. If set is a "separate sound I.F. receiver," it will be necessary to check tubes in these stages as well as those indicated above.

Picture out of horizontal sync.

Adjust horizontal control on front of set. Control may be defective and need re-

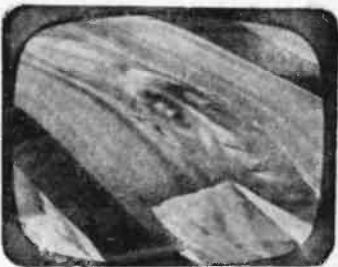

placement. Try adjusting automatic frequency inductor on chassis. Check horizontal oscillator tube and replace if necessary.

Blurred, indistinct picture.

Focus control out of adjustment, or (in some cases) shorted or burned out. Defective rectifier tube in low voltage cir-



cuit, or a shorted focus coil will prevent sharp focus. Also check for defective electrolytic capacitor(s) in low voltage filter.

Pictures jump.

Look for a loose connection on sockets of vertical sweep oscillator amplifier tubes. Test tubes for possible internal defects. Check vertical hold control for a defective resistance element and replace if necessary.

Picture good, but sound hollow, distorted, or has ringing background.

Microphonic, or gassy tubes in audio section of set. Check and replace suspicious tubes. Also look for defective electrolytic capacitor in the cathode circuit of audio output, and paper coupling capacitor between audio amplifier and audio output tubes.

The above guide should cover a large number of all TV set failures. If your trouble differs from the symptoms listed, or is not remedied by the suggestions given, do not tinker with the set! Some TV repairs require apparatus and skill beyond that possessed by the experimenter. Call in an expert repairman!

All component parts and tubes technically described in this column are clearly shown and identified in both Sams and Rider data available for your set. Their data is not of a "how-to-fix" nature which is the purpose of this Trouble Guide when used in conjunction with basic information covering your specific set.

Because of its special heat dissipating ceramic insulation, the IRC type AB wire-wound resistor is suggested for dropping the voltage in preference to those with smooth porcelain insulation.

Three stages of resistance-coupled amplification are provided by half of the 12AX7 twin triode serving as input stage, the remaining triode section as inter-stage amplifier, and a 50C5 pentode as output stage. Halfwave rectified *d-c* current is supplied to the circuit by the 35W4 tube.

The 12AX7 is a miniature tube with 9-pins, while the 50C5 and 35W4 are 7-pin types. You'll note that not every pin on every socket is wired into the circuit. Do not attach wires to blank socket lugs.

The three 3/8-in. holes located on the front apron of the chassis are for mounting the volume control-switch, phono input jack and a rubber grommet for protecting the line cord. While the amplifier chassis is wired "live," its eventual installation in the speaker cabinet eliminates any exposed metal.

The original cabinet was a wall intercom type of plywood construction, covered in brown leatherette with a plastic mesh grill opening. A cabinet designed for an 8-in. speaker allows space for the 6-in. PM speaker and the chassis.

To insure good quality, we suggest you purchase a speaker with as heavy a magnetic slug as is available from your dealer. These slugs range from 1 to 3.16 oz. or thereabouts for a 6-in. speaker. The larger the slug, the better and more expensive the speaker. Choose, too, a speaker with a 2500-ohm audio output transformer already attached to its frame, or a speaker with mounting bracket for an output transformer if it is purchased separately. To connect a separate transformer, mount it to the speaker frame, then solder the two bare transformer leads to the speaker voice coil terminals (Fig. 6). Primary leads of the transformer are insulated and usually

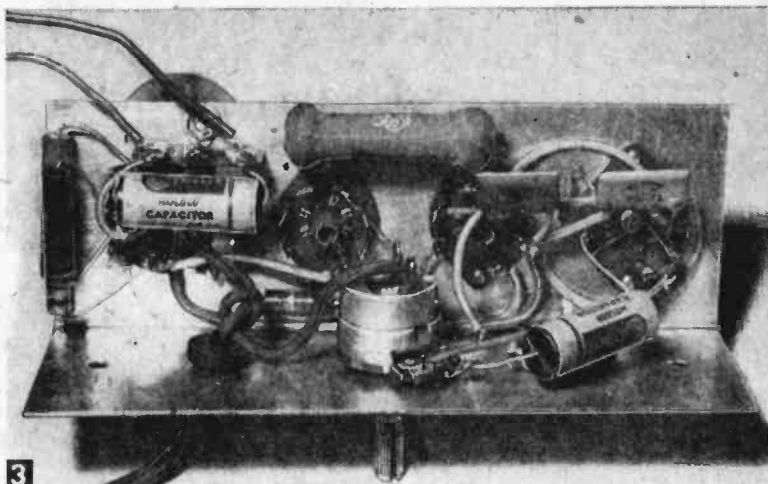

3 Bottom view of chassis showing neat arrangement of components and little wiring required for hook-up.

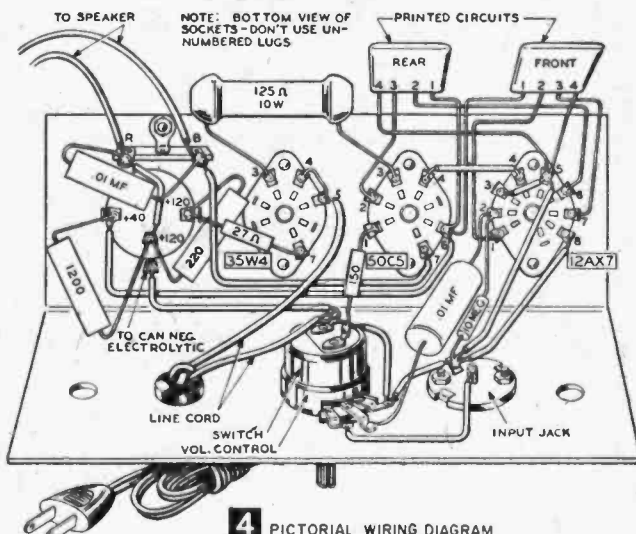

4 PICTORIAL WIRING DIAGRAM

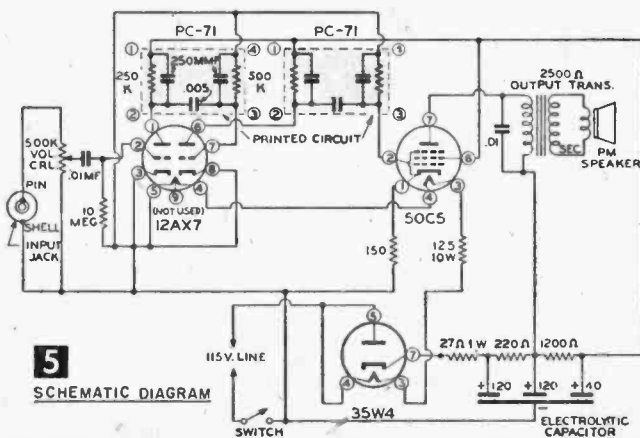

5 SCHEMATIC DIAGRAM

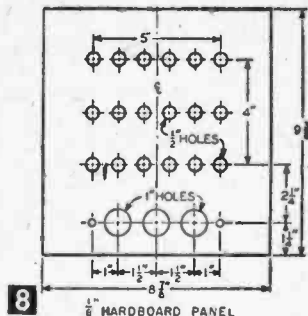
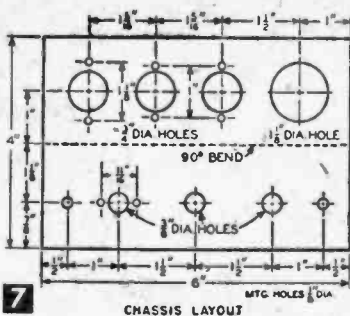
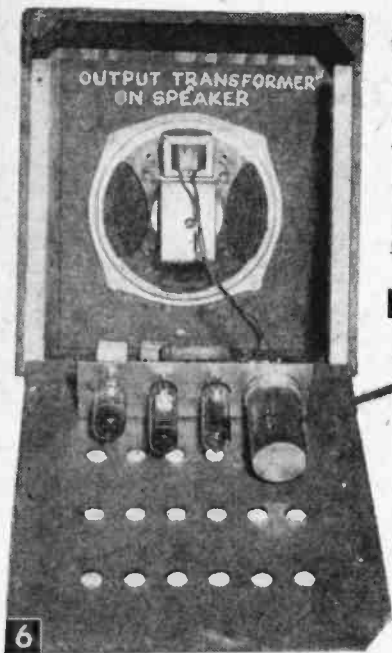

7 Chassis attaches to back of cabinet. Back is, in turn, screwed to cleats glued inside speaker cabinet. Holes are for ventilation and to mount parts.

An ordinary phono pick-up makes a surprisingly good contact mike and is attached with #4 self-tapping screws.

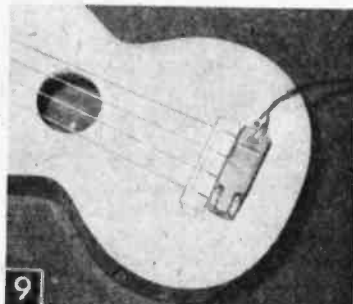

colored red and blue. Solder these leads to the 2-lug tie-strip marked "to speaker" (Fig. 4).

Both the Pictorial Wiring Diagram and Fig. 3 show that, small as it is, there is no crowding of parts under the chassis. Two CRL #PC-71 printed interstage plates—each smaller than a postage stamp eliminate ten individual and much larger components and their wiring which might otherwise be required.

The completed amplifier is mounted to the cabinet back as shown in Fig. 6. Since speaker cabinets are furnished without backs, you can make your own out of hardboard (Fig. 8). Drill 1/2-in. dia. ventilation holes and cut the three 1-in. dia. holes to allow for clearance of controls and plug on line cord. The two 3/4-in. holes adjacent to the 1-in. openings are for mounting the chassis. Two wood cleats glued inside the cabinet receive four wood screws to hold the back panel to the cabinet.

In order to mount the 6-in. PM speaker back of the grille opening, you must first mount it on an 8 by 9-in. baffle cut from 1/8-in. hardboard. In the exact center of the baffle panel, cut a 5-in. dia. hole using a "fly-cutter" or saw. Mount the speaker back of this opening, and mount the panel, in turn, inside the cabinet. With speaker transformer leads connected to chassis, amplifier is ready for use.

You can also use this amplifier and speaker for record playing if you keep the volume control turned down. With a phono player plugged into the input jack, the power output exceeds the capacity of the 6-in. speaker when volume control is turned up. This rattles speaker and distorts sound but won't harm it.

Instrument Pickups—All microphones, whether

crystal, dynamic, carbon granule, or ribbon are essentially voltage generating devices. The voltage and frequency pick-ups generate and deliver to the input grid of the amplifier in direct relation with the intensity and frequency of the sound waves striking the mike diaphragm.

Inasmuch as a stringed instrument's body or sound box is a large vibrating chamber, it becomes a diaphragm to drive the crystal, or moving coil in the case of magnetic type pickups. Microphones without conventional diaphragms to pick up air carried sound waves are known as *contact mikes*.

Leading radio parts houses carry contact microphones but you can rig up a very good substitute using a contact mike you may already have on hand. That is a crystal phono pickup! It, too, is a contact mike. Or you can buy a replacement phono pick-up cartridge for this purpose. Fig. 9 shows how the needle and needle retaining screw were removed from a pickup before the unit is secured to a uke with two #4 self-tapping screws, screwed down just enough to produce a clean signal through amplifier when strings are plucked. The needle holder bushing contacts the body of the instrument. When played, vibrations are carried from the instrument directly to the pickup crystal which transmits a signal to the amplifier.

The most inexpensive 78-rpm type crystal cartridge works fine as an instrument mike, since it requires 1 1/2 oz. contact pressure and can be purchased with self-generated output voltages as high as 4 1/2 volts. When this type of cartridge is screwed down securely, but not excessively tight, it has high initial sensitivity. More expensive pickups for 45 or 33-rpm, however, have

light pressure limits, and low output voltages.

Another very effective experimental contact mike can be adapted from the crystal replacement cartridge found in some hand mikes or hearing aids. These tiny wafer-like units can be attached to instrument with Scotch tape.

Contact mikes, experimental or commercial, are connected to the input of the amplifier with a shielded conductor cable. Parts suppliers list this shielded cable as crystal mike or phono pickup cable. Carefully remove rubber insulation from ends of cable, roll back copper braid, and finally insulation covering inner grid wire. Wire an JCA type phono plug to one end of the cable by connecting the inner grid wire to the pin, and soldering copper braid to the plug shell.

Connect the other end of cable to your con-

tact mike unit, by attaching braid to the metal shell or lug marked "Gnd." The inner cable wire is attached to the insulated lug of the contact mike. If connections are accidentally reversed, the amplifier will buzz loudly upon touching the metal mike or pickup housing.

Since the amplifier chassis is grounded directly to the power line, eliminate any chances for shock at the instrument by covering your homemade contact mike with Scotch insulating electrical or Mystic tape. Attach a plastic or chrome drawer pull to top of cabinet for carrying.

Although not included in the original model, you may find that a 25-mfd, 25-volt midget electrolytic capacitor shunted across the 150-ohm cathode resistor (plus to lug of 50C5 socket) improves audio quality a bit.—END

Remote TV- Radio Sound Silencer

You won't need to dash madly to the TV before answering the phone, nor smash the picture tube when a hammy huckster goes into his commercial pitch

FOR no more than the cost of a push button from your dime store and some fixture wire, you can squelch the TV sound or a radio from your telephone stand or table near your favorite chair. The installation takes only a moment, and the silencer neither shuts off the radio or TV set requiring it to warm up when turned On again, nor connects to any 110-volt power line or high voltages within the set.

Because there are no high voltages involved, you can run the squelcher's cord under a carpet without worrying about fire or shock. TV twin-wire lead-ins are excellent because they lay flat.

Mount a doorbell push button with two #4-40 x 1/2-in. machine screws and nuts on a plastic coaster (Fig. 2) after cutting a hole in the side to let the cord through. Determine the required run of connecting fixture cord or TV lead-in and attach alligator clips to the ends opposite the push-button.

To install the squelcher, merely attach a clip to each of the lugs on the set's speaker (Fig. 3). Do not disturb any wires already soldered to these lugs. When the push-button is depressed, it shorts out the secondary (voice coil) of the set's output transformer. Voltages are so slight in these leads you won't be able to feel them. The shorting is in no way harmful to anything but the sponsor's commercial. In some instances this



1 Silencer button by telephone eliminates conversation being drowned out by radio or TV set.

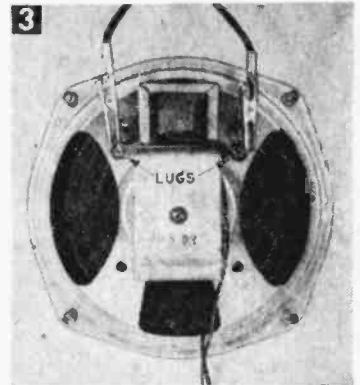
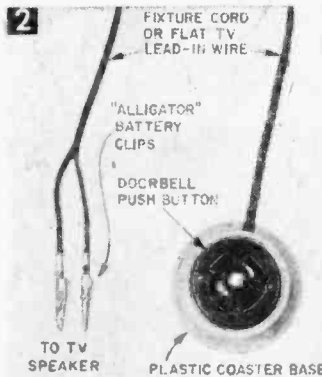

Left, doorbell button, plastic coaster and cord are dime store items. Auto shops have clips. Right, Some sets have output transformer mounted on speaker; concealed in others. Regardless, attach clips to the lugs on speaker.

device may not completely kill the sound, but will reduce it to a whisper which, for some commercials, is pleasant enough.—T. A. BLANCHARD.

Transistor Pocket Radio

Designed for personal listening, this set provides static-free reception with real volume, using a single penlite battery for power



Pocket transistor radio for headphone listening operates most anywhere, usually without outside antenna. Single alnico 1000-ohm phone provides good volume. Double headphones up to 4000 ohms will provide more volume if desired.

THIS powerful little pocket radio operates up to one month on a single 15¢ penlite battery, and will bring in stations up to 30 miles away with excellent volume. Its simple circuit consists of a high-Q ferrite antenna coil with a germanium diode (varistor) as detector, and a germanium triode (transistor) as A.F. amplifier.

The set provides excellent earphone volume

on local stations with the antenna lead wire attached to a convenient metal lamp fixture, bed-spring or screen. The finger stop on a dial phone will pick up more distant stations except in apartment and office buildings where the phone lines are installed underground in lead cables. In rural areas the set may be used with an outdoor antenna. You probably won't need a ground connection unless you are attempting to pick up distant stations.

The set employs regular radio components which may be installed in a small plastic box such as those used for cigarets, safety razors, and the like. The plastic box we used measures 3 x 2 x 1 1/4 in. Because acetate plastics melt at rather low temperatures, it may be wiser to drill the holes required by hand, rather than with power equipment. Make the 1/16 holes for the phone tip jacks and snap-in tuning coil with a small drill, then enlarge them to size with a taper or burring reamer. The general location of these holes in Fig. 3, shows that you have to mount the coil and jacks, only slightly off center in the type box we used to allow space for the penlite battery.

The jacks are mounted with metal retainer rings supplied by the manufacturer. To mount these, take a cotton spool and enlarge the spool hole to 3/8 in. Then insert Bakelite jack in hole, slip on retainer ring, and drive the ring "home" with the cotton spool. If you can't press the ring on the Bakelite jack with finger pressure, tap the spool gently with a small hammer.

The ferrite-tuned antenna coil has a snap-in mounting. Press the bayonet end of the coil into the remaining 1/16 hole until tabs click in

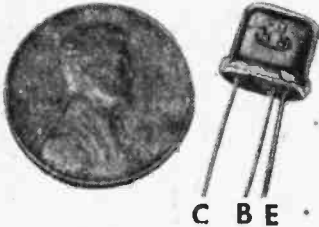

Parts fit nicely inside a 3 x 2 x 1 1/4-in. plastic box. Note penlite battery is wired directly into circuit since long in-use life requires infrequent replacement. Inset shows RR-38 transistor compared with a penny. Left-hand lead (C) is Collector; center lead (B) is Base, and right-hand lead (E) is Emitter.

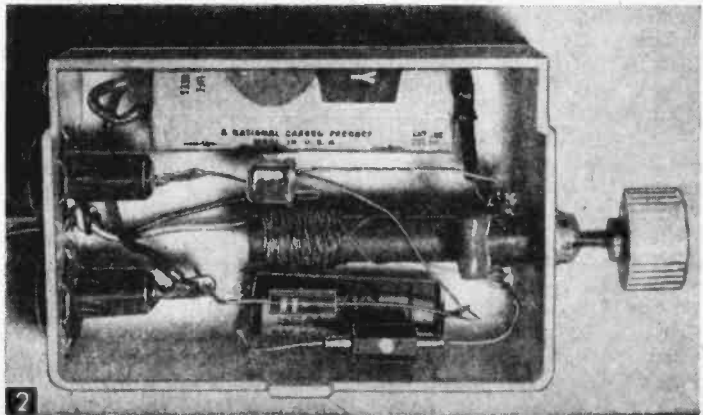

place. Tuning is accomplished by a 4-40 brass screw which moves the ferrite core in and out of the coil. To simplify tuning, we attached a threaded Bakelite knob on the end of the screw, using a 4-40 nut to lock it in position. A 4-40 cap nut can also be used as a tuning knob.

You can wire the individual components in place using their "pigtail" leads. But remember to solder two short lengths of fairly stiff hook-up wire to the battery before installing it in the case. When soldering in the diode and transistor, grasp these leads with a small pad of damp cotton to block transmission of heat up the pigtail during soldering; excessive heat on the pigtail leads can affect their internal adjustments.

Not much larger than a kernel of stock corn, the Radio Receptor #RR-38 P-N-P Junction type transistor used in the audio frequency amplifier (Fig. 2) is hermetically sealed. You could use transistors such as the CK-722 or 2N34, but the RR-38 can be wired directly into the circuit, as in Fig. 3. Or, by clipping the phosphor bronze pigtails short, you can mount in a miniature socket.

To identify the leads on the RR-38, note in Figs. 3 and 4 that the center pigtail is B (base); the pigtail next to center lead is E (emitter); and the pigtail lead spaced farthest from the center base lead is C (collector). Although this transistor lead arrangement is the generally accepted standard, you may find some makes of transistors have different lead arrangements. If the leads are not arranged as shown here, be sure your parts dealer furnishes a wiring diagram with the unit.

Using a single 1000-ohm alnico headphone, our volume proved excellent with a single penlite delivering 1½ volts. However, you can further increase the volume by wiring two penlite cells in series, which will deliver 3 volts to the transistor. And, while the standard #915-AA penlite cells can be used, two of the *slim* or *pee-wee* batteries will fit better. The coupling capacitor shown as .02 mfd. (Fig. 3) may be an even larger capacity. Some dealers can furnish miniature capacitors designed for 200 v.v. A midget 1 mfd. unit occupies about the same space as a .02 mfd. rated 600 v.v.

Note that there is no switch required for opening the battery circuit when the radio is

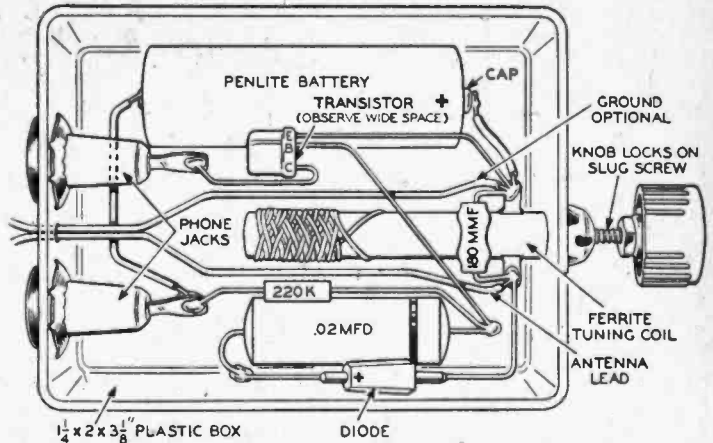

3 PICTORIAL DIAGRAM

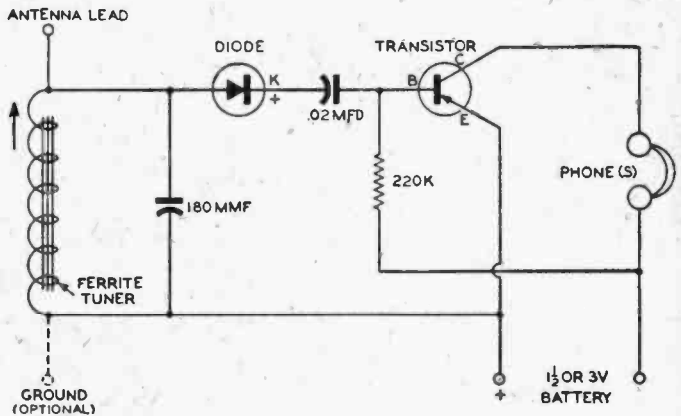

4 SCHEMATIC DIAGRAM

MATERIALS LIST—TRANSISTOR RADIO

- 1 small plastic box
- 1 ferrite slug-tuned radio antenna coil
- 2 Bakelite phone tip jacks
- 1 .02 mfd. paper capacitor
- 1 180 mmf. ceramic capacitor
- 1 220 K (220,000) ohm 1/2 or 1/4-watt resistor
- 1 germanium diode (RR-1N81, 1N34, 1N60, etc.)
- 1 P-N-P junction type transistor (RR-38, 2N34, CK-722, etc.)
- 1 or 2 1000 or 2000-ohm magnetic headphone (crystal type will not work)

Misc. threaded knob, hookup wire
 A kit containing plastic box and all parts listed above except transistor and headphone is available from Electro-Mite, P.O. Box 636, Springdale, Conn., for \$3.50 postpaid. 200 ohm double phones are available for \$2.25 pp. Transistor \$4.50.

not in use, since removing either phone tip from its jack opens the collector circuit and the transistor ceases to draw battery current.

The 180 mmf. ceramic capacitor connected across the tuning coil allows the set to tune from about 1590 to 640 kc. In areas where stations operate below 1590 kc., leave out this 180 mmf. unit. Where stations are between 640 and 550 kc., substitute a capacitor of about 330 mmf. for the 180 mmf. size.—T. A. BLANCHARD.

One way to save yourself money and time when taking night and indoor pictures is by

Building a low-cost **SPEEDLIGHT**

By ROBERT L. McINTYRE



FLASH photography can get pretty costly with bulbs costing from 12 to 20 cents each, but you can shoot fast action at night for less than a cent a picture with this home-built speedlight. Parts cost about \$40, including the reflector and tube, and are mounted in a metal lunchbox for easy carrying. The completed speedlight compares with units selling for \$75-100 and works on any camera that is synchronized for flash whether it has a shutter with contacts built in or an external solenoid tripper.

The basic speedlight puts out less light than that of a small flashbulb, but still plenty for taking black and white pictures indoors at normal working distances and color shots with the light fairly close to the subject. The "guide number" for Daylight Kodachrome is 20, which means that you can shoot with the lamp 10 ft. from the subject and get correct exposure with your lens set at $f/2$, or at 5 feet with lens at $f/4$. As you know any flash guide number is divided by the distance from lamp to subject, in feet, to get the lens aperture required. With regular, orthochromatic films the guide number is 45 and with fast, panchromatic films it is 80.

You can develop more light by substituting larger capacitors. See Table A for size, cost and light guide numbers. Only one additional change is required when larger capacitors are employed. The 4-mfd. 350-w.v. capacitors should be replaced with 8-mfd. capacitors of the same voltage. This will keep the recycling time short—around 10 or

Compact and easy to carry, the speedlight built into a lunchbox replaces flash bulbs for night and indoor shots.

Capacitors (A) take up most of the space inside lunchbox. Other parts are (B) On-Off switch, (C) neon indicating lamp, (D) Jones receptacle, (E) at side rheostat adjustment, (F) panel #1, (G) panel #2, (H) safety-lock screw, also through box lid when closed and (I) plug for 115-volt a-c line that supplies current.

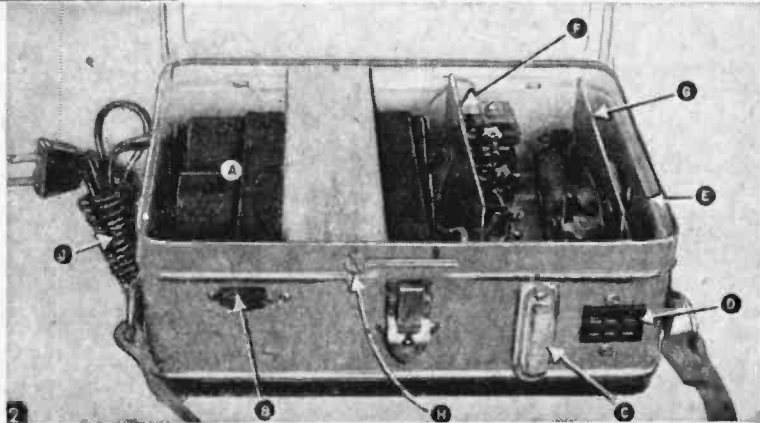

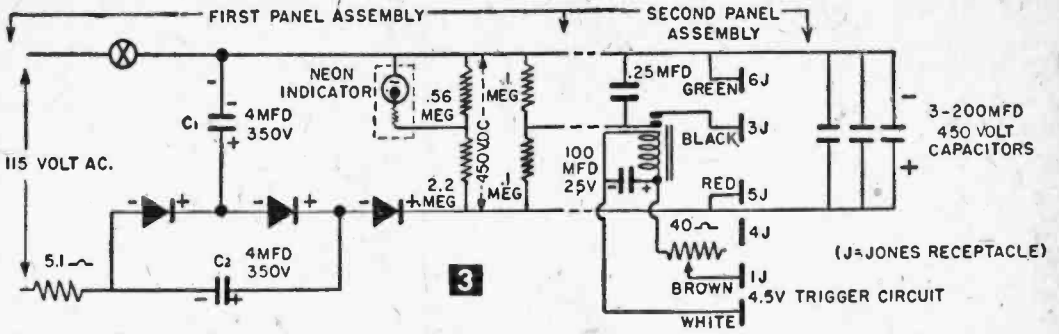

Schematic diagram. Be sure to observe polarity of electrolytic capacitors and selenium rectifiers.

12 seconds.

This speedlight employs the "trigger tube" type of circuit. Before getting into the construction details, let's see how it works. The power source is 115-volt a-c. When you plug in the line cord and turn on the switch, the capacitors begin charging immediately. It takes about 10 to 12 seconds to charge them completely, and the neon indicator lamp flashes. Then you are ready to shoot.

At this time the circuit from capacitors to flashtube is complete, but there is no flash. An addi-

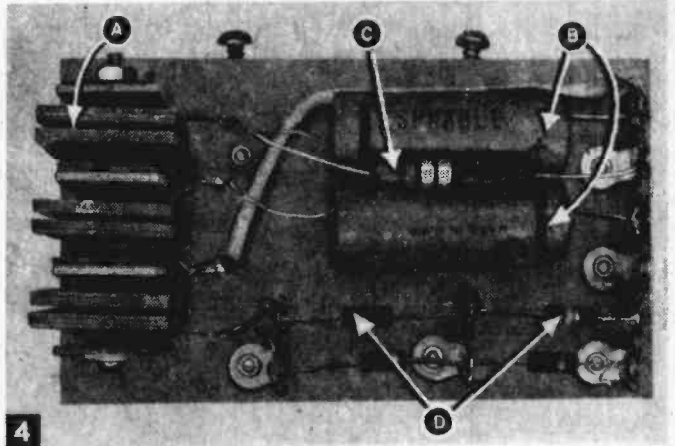

Assembly of panel #1: (A) selenium rectifiers, (B) 4-mfd capacitors, (C) 5- to 6-ohm resistor and (D) resistors.

MATERIALS LIST—LUNCHBOX SPEEDLIGHT

- | | |
|-----|-----------------------------------------------------------------------------------------------------------------------------------------------------------|
| No. | Item |
| 3 | Capacitors, 200 mfd., 450 v.v. C-D type FB 10063 |
| 2 | Capacitors, 4 mfd., 350 v.v. tubular electrolytic |
| 1 | Line cord, 8 ft., with plug, strain relief clip and rubber grommet |
| 1 | SPST slide switch with mtg. screws |
| 1 | Resistor, 5 to 6 ohm, 2 watts, wire wound |
| 3 | Selenium rectifiers, 65 ma. |
| 2 | Resistors, 1 megohm (100,000 ohm) 1/2 watt |
| 1 | Resistor, 2.2 megohm, 1/2 watt |
| 1 | Resistor, .56 megohm (560,000 ohm), 1/2 watt |
| 2 | Panels, bakelite or Masonite, 2 3/4 x 4 3/4 x 1/16" |
| 6 | Angle brackets, 3/8 x 3/8 x 1" |
| 7 | Dual terminal lugs |
| 16 | Rivets or nuts and bolts to fit angle brackets and terminal lugs |
| 4 | Screws, 8 x 1/2" self-tapping sheet metal type |
| 1 | Rheostat, 40 ohms |
| 1 | Screw, #6-32 x 2 1/4" 1 Hexnut, #6-32 |
| 1 | Capacitor, 100 mfd. 25 v.v. (tubular type electrolytic) |
| 1 | Relay, 8 ohms SPST normally open contacts (Sprague #FA-103) |
| 1 | Receptacle and plug, 6-prong Jones, with mtg. screws and nuts |
| 1 | Capacitor, .25 mfd. 400 v.v. tubular paper |
| 1 | Neon indicator Drake type 110 Drake Neon Indicator Lights |
| 1 | Light unit, assembled, with Kenlite DX flash tube mounted in reflector above medium screw base plug to fit standard flash battery case (Harwood Mfg. Co.) |
| | 5 ft. 5-wire conductor cable, plastic insulated (2 # 18 wires) |
| | (All above parts are available in kit form from Harwood Mfg. Co., 466A West Superior St., Chicago 10, Ill.) |
| 1 | Lunchbox, metal, approx. 6 1/2 x 8 1/2 x 3" |
| 1 | Leather shoulder strap with hanger brackets and screws |
| 1 | Wood block, approx. 6 1/4 x 1 1/2 x 3/4" |
| 2 | Screws, wood, No. 8 x 3/4" |
| 1 | Flashgun with medium screw socket and 1 1/2" diameter barrel (Heiland, Service, Kalart, etc.) with 3 size D flashlight cells |

HIGH-POWERED UNIT

Parts are the same as above except for substitution of 3 300 mfd. 450 v.v. capacitors or 3 525 mfd. 450 v.v. capacitors for first unit on list and 2 8 mfd. 350 v.v. capacitors in place of second unit.

tional surge of current is required to ionize the gas within the tube and make it fire. This surge is supplied through a relay actuated by the current from a regular flash battery case. Chances are you have one now. Any 3-cell unit is suitable if it has a socket to take medium screw base bulbs, such as No. 11, 40 or 22.

Before starting construction, collect all the parts in the materials list. If you don't have a 3-cell flashing unit you can probably buy a used one at your photo store for a few dollars. With it should be a bracket to hold it on the camera and a cord to connect it with the shutter terminals or synchronizer solenoid.

You may have to change the layout of parts if you use a different lunchbox. (We bought ours for \$2.37 from Montgomery, Ward.) The three capacitors are held together with friction tape. About six turns of tape near their tops and the same number 1 1/2 in. lower will hold them and, at the same time, make it possible to anchor them with the wooden block which fits in between the two coils of tape and fastens to the case at each end. They are wired together in parallel, with a red lead coming from the positive side and a green one from the negative. Positive terminals will be marked "+" or with a drop of red paint. Leave the leads about 8 in. long so the capacitors

BEND UP TO
DELAY ACTION

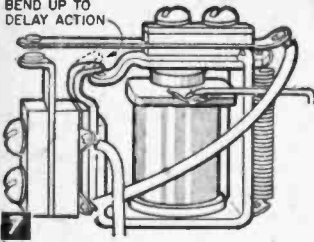

To roughly adjust relay closing time, bend lug (A) down to pull points (B) closer together and shorten delay time—up to lengthen delay time. Don't get points too far apart or relay may not be able to close or so close that current may jump between contacts. You can check relay from battery case without main power supply.

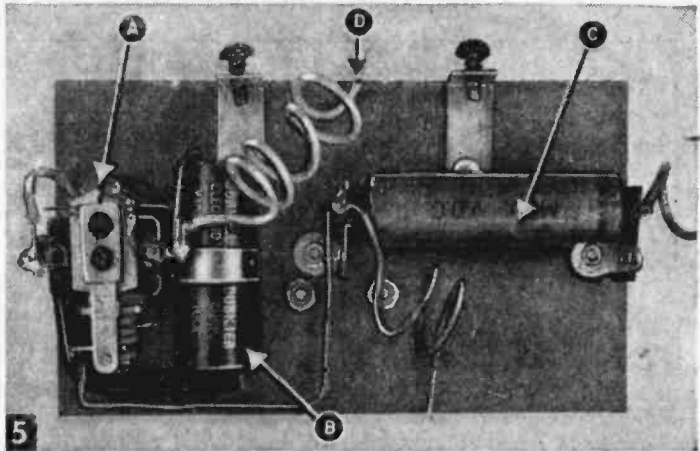

can be soldered into the circuit later on, without actually being placed in the case.

Next come the two panel assemblies, designed so they can be put together easily outside the case. Lay out the parts on each panel, as shown in Figs. 4 and 5, and mark the positions for drilling each hole.

Complete as much wiring as possible while these assemblies are out of the case, soldering on the leads that will go to the switch, neon indicator and Jones receptacle. If the lunchbox has a handle, discard it and mount the switch, neon indicator and Jones receptacle in the area of the holes. Mark off the area to be cut out for each unit, then drill a line of holes around the inside of the line. Force the piece out, and file the edges smooth. Drill the screw mounting holes.

The hole through which you adjust the rheostat that controls the time lag of the unit must be cut in the case carefully. Put the second panel assembly into the case and fasten it in position without drawing the screws up tight. Mark the point opposite the rheostat shaft where the hole should go. Then remove the assembly and use a center punch to make a small dent in the case at the mark. Drill the $\frac{3}{8}$ -in. hole on this center from the outside. While you are at it, drill the two holes near the edge of the open side of the box for the screws that will fasten the wooden block holding the capacitors in place. After all holes are drilled, wipe out the box and clean off the work table so no stray bits of metal get inside.

Complete the wiring and fasten in the panel assemblies and capacitors. Close the lid of the box and fasten it with a round-headed wood screw through a hole in the edge of the lid in line with the wood block. This screw is important, as a safety factor. When it is drawn up tight, the lid of the box cannot be opened merely by releasing the catch in the usual way. The circuit is designed so the current in the capacitors will bleed down to a safe level in a minute or two after the switch is turned *Off* or the line cord is unplugged. It usually takes about that long to locate a screwdriver and remove the screw. Nev-

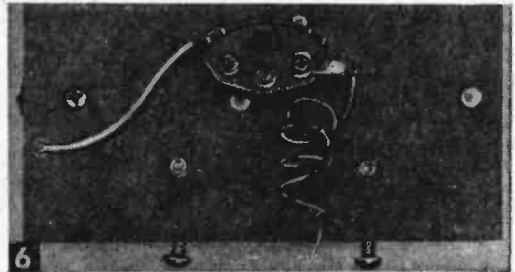

Assembly of panel #2: (A) relay, (B) 100 mfd 25-volt capacitor, .25 mfd, 400-volt capacitor and (D) lead to rheostat on back of panel. Below is the back of assembly panel #2.

ertheless, the first thing to do upon opening the box after use is to discharge the capacitors by shorting them with a screwdriver that has a wood or plastic handle. Then you know you are safe.

Now you are ready to make some tests. Plug in the line cord and turn the switch *On*. Watch the neon indicator. When it flashes *On*, the capacitors are fully charged. It may take up to a minute at first, depending on how long the capacitors have been on the shelf. They are "formed" by use, and after a long period of inactivity they require re-forming by charging and discharging a few times. Once this has been done, they will charge rapidly and be ready for use. Wire up the 5-wire cable between the Jones plug and the socket of the flashtube. Note that two of the wires connect to the medium screw base plug. In kit form, this is already wired up.

Place the flashtube unit in the flashgun receptacle and fasten it down with the three knurled screws provided. If it doesn't fit snugly, wrap a length of friction tape around the head of the flashgun first. Then insert the Jones plug on the flash unit cord into the power pack receptacle.

If the neon indicator has not flashed on by this time, pull out the line cord, unscrew the safety screw, open the box, discharge the condensers to play safe and to see whether any current has reached them, and then re-check your wiring

against the diagram. If the unit begins to smell like rotten eggs shortly after you turn it on, do the same thing. The smell is caused by the large 5- to 6-ohm resistor placed above and between the two 4-mfd. capacitors. This resistor is the safety valve of the circuit. If there is a short, it is most likely to burn out with a rotten egg smell. Check the circuit before replacing it. It shouldn't burn out if the circuit is wired right.

With the speedlight working, you're ready to synchronize it with your camera. Connect the flash cord from flashgun to shutter. If the lens-board is removable, take it off to make the check. Otherwise, take the film out of the camera so you can look through the lens as you click the shutter. Then trip the shutter to fire the flash, looking through the lens to see if you can see the flash through the shutter. When the aperture of the lens is wide and the unit is synchronized perfectly, you will see a bright blob of light that fills the whole lens. If the flash is early or late, you will see no light at all or, if the error is slight, you will catch shutter blades partly open.

For synchronizing a focal-plane miniature like the *Leica*, use only a shutter speed of 1/20 or 1/30 second. Since you can't look through a focal-plane miniature, set up the flash unit in front of you, aimed away. Then hold the camera out at arm's length, facing you, with lens removed, so you can see the shutter curtain before you shoot. When you trip the shutter, the curtain will open and the flash will fire. When synchronization is perfect, you will see the film pressure plate instead of the shutter curtain by the light of the flash.

The rheostat adjusts delay time of firing the speed light. When the adjusting screw is turned all the way to the left, you get the least delay. This is the setting to use for shutters that have built-in synchronization with "X" or "F" settings which provide zero to 5 milliseconds delay. The problem is to match the time-lag of the flashing unit to the lag between closing of the shutter contacts and the time when the shutter leaves reach their maximum opening.

Turning the adjusting screw to the right adds resistance to the flashing circuit, increasing the time lag. Shutters with built-in synchronization for class "M" lamps and solenoid-type synchronizers will require a setting toward the right end of the adjustment. Their time lag is 20 milliseconds.

If shutter and flashtube fail to synchronize within the entire range of the rheostat adjust-

ment it will be necessary to make a mechanical adjustment of the relay. With a shutter that has "X" or "F" delay, chances are that the relay is too slow. If the shutter has "M" delay or uses a solenoid it probably is too fast. Remove the line cord from the wall outlet, open the case, discharge the capacitors for safety, and then remove the screws holding the panel assembly containing the relay and lift it up where you can work with it. Adjust the little metal lug that holds the movable commutator of the relay at rest as shown in Fig. 7. The range of delay covered by the rheo-

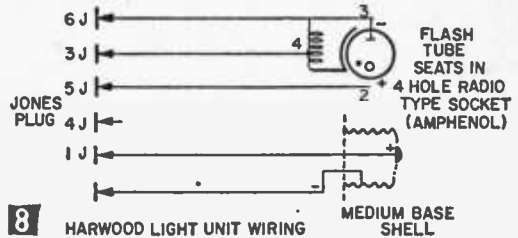

Connections at flash tube and battery socket. Flash-tube and reflector unit is slipped into top of any 3-cell flashgun that takes medium screw base bulbs. Flash cord from shutter attaches to battery case the same way as when taking conventional flash bulb pictures.

stat is quite broad so one mechanical adjustment of the relay should bring its speed to a point where final timing can be accomplished easily.

One of the beauties of working with a speedlight unit like this is that you can check it visually, under actual working conditions, at practically no cost. If you see the light of the flashtube through the open shutter, you know synchronization is perfect. The check is an easy one to make at any time. You can compensate for weak batteries by reducing the resistance of the rheostat while making this visual check, though except in emergencies it's best to use fresh batteries.

The flash guide numbers from Table A are a starting place in determining exposure. You may want to modify exposures somewhat after seeing the results of your first test shots. Flash guide numbers, like film exposure indexes, are intended only as a rough guide.

Speedlight units are likely to emit the same amount of light for shot after shot, but that exact amount may be different for outfits that use components nominally the same. Once you get an accurate measurement of the results that the light produces with your own particular equipment you can maintain consistent quality.

Working with speedlight has an interesting by-product, in addition to the obvious saving of flashbulb costs. Its relatively short exposure time stops subject motion most effectively and also eliminates blur due to camera movement—the most common cause of fuzzy pictures. You may find that your camera is capable of taking sharper photos than you ever dreamed were possible if you have been an unknowing victim of the camera shakes or shimmies.—END

TABLE A—LIGHT VALUE AND COST OF CAPACITORS

| Capacitors (3 needed) | Watt-Seconds Output | Flash Guide* Color | Plus-X Super-XX | Cost (Each) |
|--------------------------|------------------------|-----------------------|--------------------|----------------|
| 200 mfd., 450 w.v. | 60 | 20 | 80 | \$ 4.03 |
| 300 mfd., 450 w.v. | 90 | 25 | 95 | 7.06 |
| 525 mfd., 450 w.v. | 150 | 32 | 125 | 13.23 |

*Guide numbers are divided by distance from lamp to subject (in feet) to determine f-number of lens opening. Color guide number is for daylight-type Kodachrome or Ansco Color. Light output may vary with individual equipment and technique.

Radio Direction Finder for \$2

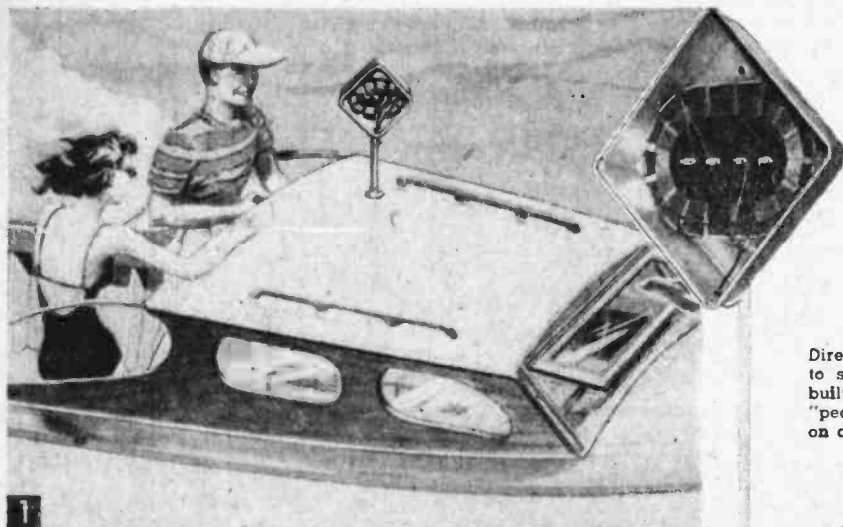

Keep your seafarin' ways up to date with the electronic age with a loop radio direction finder.

Any portable or marine radio becomes a practical direction finder with this cake pan loop antenna—an excellent aid for those who can't afford the very expensive commercial direction finders

CONVENTIONAL radio direction finders are both complex and expensive. However, any portable marine, or mobile radio set can be easily converted into a practical direction finder. As any owner of a portable or power line operated loop radio knows, turning the radio and its loop antenna increases or decreases the signal of a weak or powerful station depending upon the set's position in relation to a particular station.

Using your present loop or whip antenna set, you can steer your lake or coastal craft to shore without maps or expert navigation skill. Bear in mind, of course, this device is a direction finder and not radar. It cannot indicate other craft in your path. In fog or storm, you must still proceed with utmost caution.

Operating the direction finder is simple. The present loop or antenna coil in your marine radio is removed and replaced with a loop

Direction finder loop connects to set terminals of original built-in loop. Rotating mast "peaks" signal for homing on a known station with aid of compass.

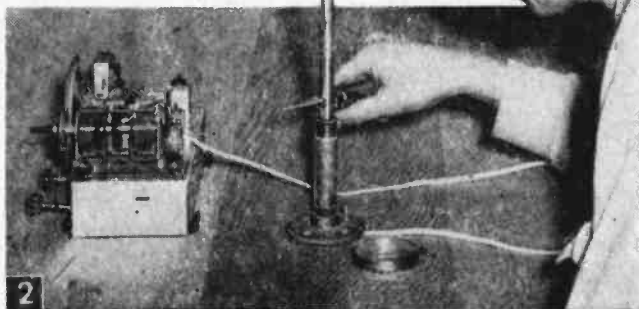

MATERIALS LIST—RADIO DIRECTION FINDER

- | No. | Size and Material |
|-----|-------------------------------------------------------------------|
| 1 | $\frac{3}{4}$ " O.D. Reynolds "Do-It-Yourself" Aluminum |
| 1 | 2 x 8 x 8" aluminum cake pan |
| 1 | $\frac{3}{4}$ " std. gage iron pipe nipple 3" long |
| 1 | $\frac{3}{4}$ " pipe flange |
| 1 | replacement loop antenna (or use loop antenna from present radio) |
| 1 | $\frac{1}{4}$ " O.D. rubber grommet |
| 1 | 3' length of plastic-insulated hook-up wire |
| 2 | $\frac{1}{4}$ " I.D. x $\frac{3}{4}$ " plastic spacers |
| | Misc. screws and nuts |

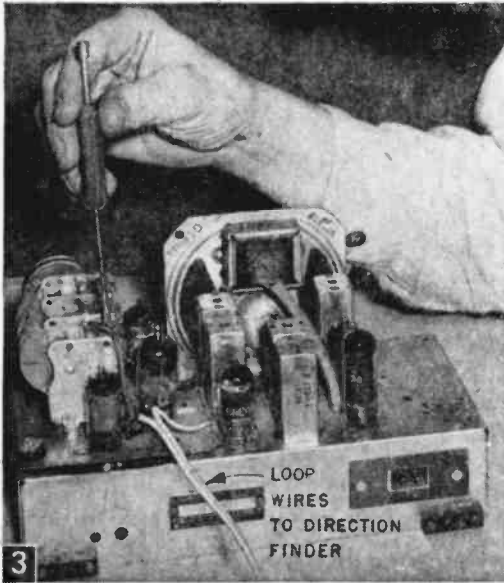

Trimmer of large section of tuning capacitor can be adjusted to compensate for capacity added to circuit by loop extension. Leads in foreground go to loop.

mounted in a metal reflector which has a 360° rotation but with a stop to prevent twisting off the wire lead. Rotating the antenna causes a known shore station to come in at maximum

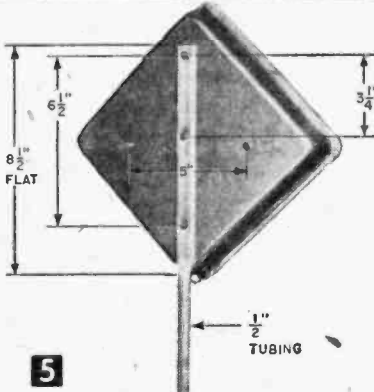
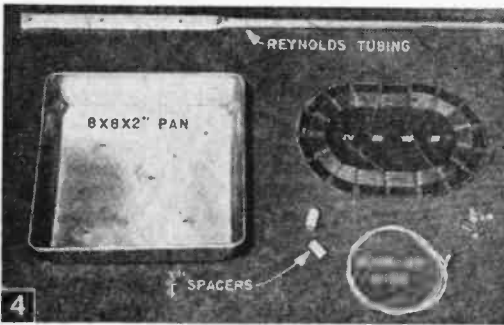

5

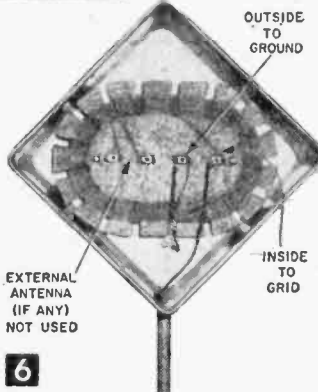

6

Left, Mounting of pan to mast flattened in a vise. Right, Lugs connecting to outer 1-turn coil are not used. Inner wire lug connects to set's grid; outer lug to ground. Bring inner wire down through aluminum tube and ground outer lead to mast and mast to chassis.

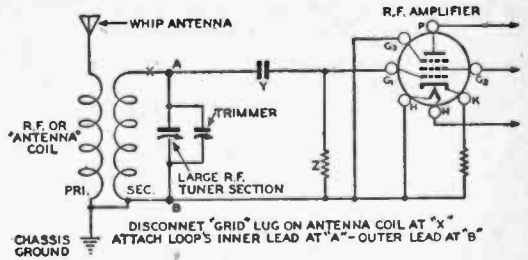

7 A TYPICAL INPUT SCHEMATIC - RADIOS WITH EXTERNAL ANTENNAS

Note:—If loop does not work efficiently, short out capacitor Y, and disconnect resistor Z. Y and Z not employed in some sets.

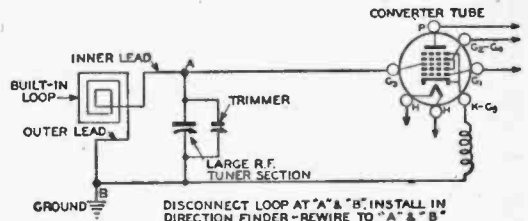

7 B TYPICAL INPUT SCHEMATIC - SETS WITH BUILT-IN ANTENNAS

volume. All you have to do is steer a course indicated by the pointer on the direction finder to reach shore safely.

Parts for the direction finder cost less than \$2. The mast is a length of Reynolds "Do-It-Yourself" aluminum 3/4-in. O.D. tubing. You'll also need a 29¢ 2 x 8 x 8-in. aluminum cake pan sold by all variety stores, either the loop removed from the radio set or a new one, and a 3/4 x 3-in. pipe nipple and 3/4-in. pipe flange. If the tubing fits too loosely in the nipple, wrap adhesive tape around it to provide a rigid, but free-turning fit.

Flatten 8 1/2 in. of the tubing in a vise, drill 3 holes as in Fig. 4 and 5 and attach to the cake pan with #8 x 1/4 in. aluminum machine screws.

Mount the loop on metal, plastic or wood spacers, 3/4 in. long with hole to clear the #6-32 x 1 1/8 in brass machine screw.

Most ordinary radio loops have only two terminal lugs. Some loops have two additional lugs which connect to one outside turn of the coil. This winding is for coupling an external antenna and is not used. If the loop received from your radio supplier has four lugs, use only the two at the ends of the multi-turn loop winding (Fig. 6).

Bring the inner loop connection through a rubber grommet in the cake pan, then through a 1/4-in. hole in the

GET THE WORLD'S LEADING RADIO & TV CATALOG



free!

VALUE-PACKED

308
PAGE 1955

ALLIED ELECTRONIC BUYING GUIDE

**Builders and Experimenters:
Save on Everything in Radio & TV!**

You'll find everything you'll need for building any project in this publication in the 1955 ALLIED Catalog. Select from the world's largest stocks of parts, tubes, tools, kits, books, diagrams—plus Amateur equipment, TV components, Hi-Fi equipment, test instruments, recorders—at lowest, money-saving prices. Write for your FREE ALLIED Catalog today!

POPULAR ALLIED KITS

Famous Radio Lab Kit (10 Kits In 1)

Here's the most instructive Experimenter's kit you can buy. With it, you can build a broadcast receiver, phono amplifier, phono oscillator, signal tracer, electronic timer, photo cell relay, home broadcaster, electronic switch, etc. Fascinating! Instructive. Complete with all parts, tubes, microphone. 12-page manual. Shpg. wt., 10 lbs.

83 S 265. Radio Lab Kit, only.....\$14.25

Popular "Ocean Hopper" (Amazing DX)

A remarkable Short-Wave receiver. Covers 155 to 35.0 mc with plug-in coils (below). Features handspeak, for headphone or speaker use. Easy to build. Complete with all parts, tubes, broadcast coil, hardware, full instructions. For AC-DC. Wt., 5 lbs.

83 S 740. "Ocean Hopper" kit, only \$12.75
59 J 110. 2000 ohm headset.....\$1.67
Five coils (155 kc to 35 mc).....\$3.82

Ranger II Superhet (with Cabinet)

Learn radio while you build and enjoy this sensitive AC-DC broadcast receiver. Tunes 540-1680 kc; includes built-in antenna. FM dynamic speaker, automatic volume control, handsome walnut plastic cabinet. Easy to assemble from detailed manual; complete with punched chassis, all parts, tubes and cabinet. Shpg. wt., 8 lbs.

83 S 735. "Ranger II" Kit, only....\$16.75

DOZENS OF
OTHER KITS
AVAILABLE

ALLIED RADIO

ALLIED RADIO CORP., Dept. 64-G-5
100 N. Western Ave., Chicago 80, Ill.

Send FREE 308-Page Catalog

Send Kit No. 83 S 265

Send Kit No. 83 S 735

Send Kit No. 83 S 740

Coils for above

enclosed

Name _____

Address _____

City _____

Zone _____ State _____

Send for
FREE
Catalog

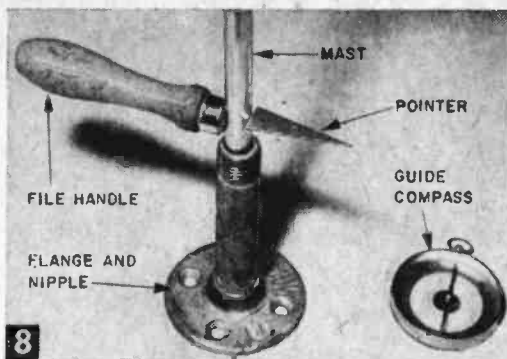

8

File handle and pointer attached to end of mast rotating in pipe holder permit direction finder to be aimed at "homing" station. Needle or float compass aids in plotting position when compared to finder's pointer.

tubing to the wire or lug on which the inner loop wire of your radio terminates. The outer lug of the direction finder loop may be grounded to the aluminum pan, and tubing grounded to set chassis or lug on set to which original outside loop wire terminates.

Drill a $\frac{3}{16}$ -in. hole through the tubing at right angles to the flattened area supporting the pan. For a pointer cut an arrow from scrap aluminum. Mount the pointer and a wood file handle to the aluminum mast with a $1\frac{1}{2}$ -in. rh wood screw.

Since one direction finder loop wire (grid) is brought down to the set through the tubing which is at ground potential, some capacitance will result which may cause a detuning effect. Once the direction finder loop has been installed, tune to a local station on the high end of the radio dial, loosen the screw of the large tuning capacitor section with insulated screwdriver until maximum volume is obtained (Fig. 3).

Marine and auto radios employ a whip type antenna and a built-in antenna coil. You'll have to buy a loop antenna for such sets since there is none which can be removed and used in the direction finder. Both antenna coils and loops connect to the same grid and ground points as indicated in schematic diagram. For either radio it is only necessary to disconnect the loop or antenna grid connection in order to install the direction finder loop. Other leads may remain intact.

If you insert an S.P.D.T. toggle switch between the set's grid and antenna coil and the new direction finder loop, it is possible to switch from standard antenna to directional loop by the mere flip of a switch.

To protect your direction finder from the elements, buy a *Pitofilm* freezer bag at a variety store and pull the transparent sack over the cake pan assembly. Tie the neck of the bag to the mast. The antenna will operate at all times with the protective covering which is unaffected by natural elements including salt spray.—END

Emergency Twin-Crystal Radio Receiver

By GEORGE P. PEARCE



else. The two germanium diodes and two capacitors in a symmetrical voltage-doubler detector circuit yield the power and the specially wound coils sift out the stations over the whole broadcast band. There's nothing to wear out. My set has operated over three years, and the only thing I do is to pull the head-

IF FLOOD, tornado or air raids cause power failures, could you get emergency directions from the Conelrad stations the government has at 640 and 1240 on the dial? Even battery-powered sets couldn't operate over an extended period of weeks, so why not build a crystal set that needs no power except the broadcast signal.

While most crystal sets will work satisfactorily in rural areas or towns with only one radio station, a set requires extra sensitivity to separate stations around cities where high-powered transmitters tend to drown out everything

phone plug when I'm not using the set to remove the load from the diodes.

Since the coils are important, let's start with them. Coils L_1 and L_2 are simply a single layer,

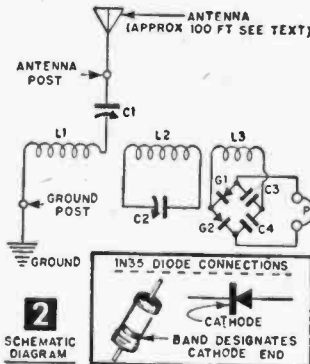

MATERIALS LIST—EMERGENCY RADIO RECEIVER

- A antenna, 100' stranded wire
- Gr. ground to water pipe or ground rod
- G₁, G₂ germanium diodes 1N35 (pair)
- L₁ tuning coil (see text)
- L₂ tuning coil (see text)
- L₃ tuning coil (see text)
- C₁ midjet capacitor, 27 plates 380 mmf (Allied #61H009)
- C₂ midjet capacitor (see text)
- C₃ capacitor, fixed tubular .001 mfd.
- C₄ capacitor, fixed tubular .001 mfd.
- P headphones, 2000-ohm resistance
- 5 x 6 x 9" steel utility cabinet (Allied #86P204)
- carrying handle
- tuning knobs (Allied #55H063)
- graduated dials (Allied #55H140)
- jack plate (Allied #55H201)
- Jack, military type (Allied #41H642)

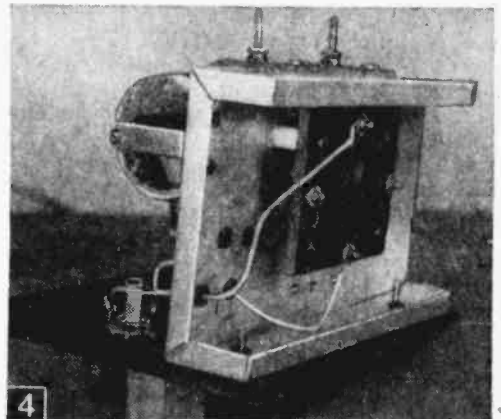
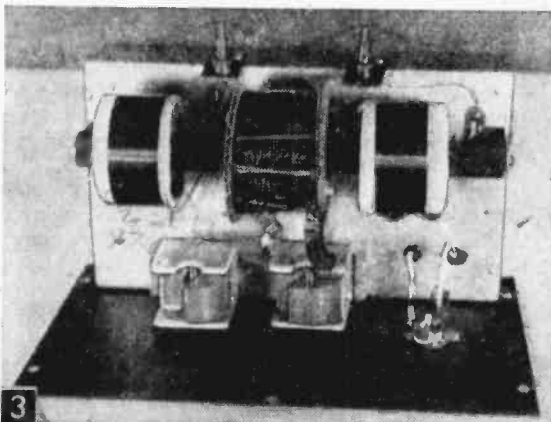

Pocket Power Pack

This compact unit provides AC-DC voltages for operating radios, amplifiers and all types of experimental electronic devices



1 Pocket-size power pack supplies d-c and heater voltages to midjet superhet tuner. Power Pack operates all types of electronic apparatus where d-c current is not over 100 ma.

ONE doesn't have to go back too many years to recall when a 5 or 6-tube radio, operated on a "power pack," weighed up to 15 pounds. And there is still an amazing number of these old sets in use!

Pocket Power Pack is quite a contrast to those bulky units of yesteryear. The radio experimenter who plays around with various projects can use this unit to supply 90-100 d-c volts for operating electronic devices with series wired tube "heaters." You can save the cost of hot and cumbersome voltage-drop resistors, by using Mazda house bulbs as heater ballast resistors.

Battery portable sets may be operated from this unit either to conserve the B-bat-

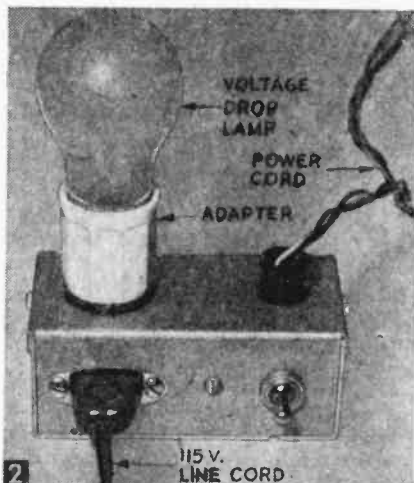

2 Power Pack is built in an aluminum radio box chassis measuring only 4x2 1/8 x 1 1/8 in. Voltage-drop resistance for tube heaters is obtained with ordinary Mazda lamps.

MATERIALS LIST—POCKET POWER PACK

- 1 4 x 2 1/8 x 1 1/8 in. aluminum box chassis
- 1 100 ma. selenium half-wave rectifier
- 1 S.P.S.T. toggle switch
- 1 20-20 mfd., 150 w. v. electrolytic capacitor
- 1 Amphenol #61F female receptacle
- 1 Amphenol #78-S3S 3-pin miniature socket
- 1 Amphenol #71-3S 3-pin miniature plug
- 1 male interlock receptacle
- 1 TV power "cheater" type line cord and plug (Allied #49T239)
- 1 2200 ohm, 1-watt resistor
- 1 27 ohm, 1-watt resistor

tery, or as emergency power. Since most modern portables use ordinary flashlight cells for A-batteries, replacement is no problem. However, the B-battery is not always available locally and is costly. This power supply will not supply A-voltage to battery sets, since the tubes are wired in parallel and have direct-heated cathodes (coated filaments).

Power Pack is constructed in a gray hammertone aluminum box chassis measuring 4 x 2 1/8 x 1 1/8 in. The LMB box used in making the original model is easily drilled, cut and slotted to receive the chassis-mounted components. Because of slight variations in the dimensions of components, holes should be drilled only after

all parts are on hand and positioned to fit the available space.

You'll see from the photos that the power pack has no exposed "live" power terminals or dangling line cords. Everything plugs in! This not only prevents the user from accidental shock when the power supply is in use, but permits the unit to be stowed away in the least possible space.

Line voltage is delivered to the power pack with TV "cheater" type power cord which plugs into the interlock receptacle on the side of the chassis. When the power pack is used to provide tube heater volt-

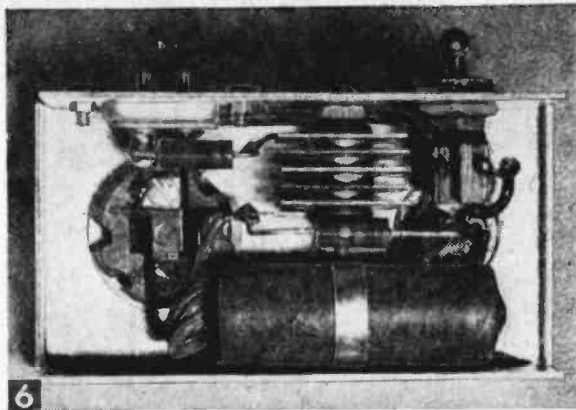
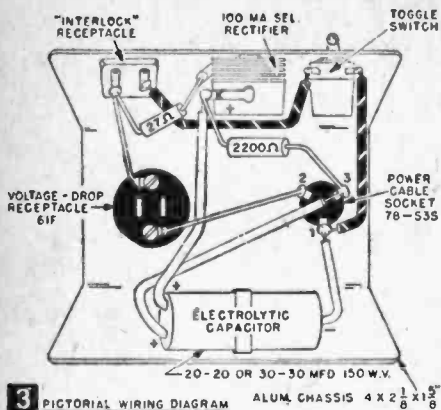

Bottom view of power pack with aluminum cover removed. Arrangement of components is similar to pictorial wiring plan.

TABLE A—MAZDA LAMP RESISTANCES

(Lamps may be clear, frosted or decorative types)

| | | | |
|----------------|-----------------|-----------------|----------|
| 15 watt | 800 ohms | 50 watts | 240 ohms |
| 25 watts | 485 ohms | 60 watts | 200 ohms |
| 30 watts | 400 ohms | 75 watts | 160 ohms |
| 40 watts | 300 ohms | 100 watts | 120 ohms |
| | 150 watts | | 80 ohms |

The size of Mazda lamp needed is determined by dividing the voltage drop required by the tube heater current, thus:

- (A) Power Line Voltage 115 (U.S. average)
- (B) Total Tube Voltage 74 (two 12-volt and one 50-volt tubes)
- (C) Voltage Drop Needed 41 (B subtracted from A)
- (D) Tube Current .15 (Check for specific tubes used)
- (E) Voltage Drop 273 ohms (D divided into C)

In the above example use 40 watt first. If tubes heat up too slowly employ the 50 watt lamp. Because line voltages run high in some areas, always try a lamp with a higher resistance than required first, then change to a lower resistance lamp if tube heaters require a very long warm-up period.

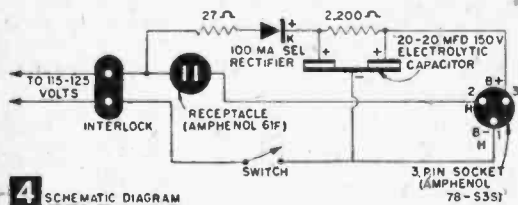

4 SCHEMATIC DIAGRAM

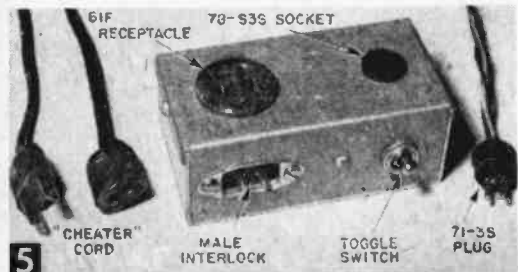

5

For both safety and compactness, everything plugs into the power pack.

ages, the desired voltage drop Mazda lamp (Table A) is plugged into the Amphenol #61F female receptacle by means of a Leviton pin-to-screw base adapter sold in all dime stores.

Both B- and heater-voltages connect to the radio or electronic device by means of a 3-wire cable fitted with Amphenol's #71-3S plug. This plug, in turn, fits the Amphenol #78-53S socket

mounted on the power pack chassis. When ordering your parts, several plugs should be ordered so that power can be interchanged from one experimental unit to another without having to disconnect the cable from one device to operate another.

Wire up the pocket pack following schematic or picture plan (Figs. 3 and 4). Make sure the selenium rectifier and electrolytic capacitor are wired up with the correct polarity. All leads are fully identified. Reversing positive and negative connections will ruin these components.

When using the power pack to supply series filament voltages to tube heaters, the approximate (but not exact by any means) line drop resistance must be determined. With just a few exceptions, all modern radio tubes employ either 6-volt heaters which draw 0.3 amps or tubes with 12-volt or higher heaters which draw only 0.15 amps. The first digits of a tube number indicate the tube's heater voltage. The middle letters, its type, and the last number indicates the number of elements in the tube.

To determine the size Mazda lamp required for use as a voltage drop resistance add the voltages of all tubes wired in series. For example, a radio tuner with two 12-volt tubes totals 24 volts. Subtract 24 volts from 115 line voltage and you have 91 volts to dissipate. Since the tuner uses 12-volt tubes their current consumption is 0.15 amps. Divide 0.15 into 91 and you get 600 (ohms).

Unlike ordinary wire-wound resistors, Mazda lamps act like air-filled shock absorbers. The nearest Mazda lamp to 600 ohms is the 25-watt size which has a cold resistance of 485 ohms. This lamp, however, is a perfect ballast for two 12-volt, 0.15-ampere tubes wired in series.

When wiring tubes in series, the voltages of individual tubes may be mixed so long as all tubes have identical current ratings. An inexpensive radio tube manual will give you the current ratings on all tubes. Radio parts houses stock these tube manuals.—END

AM-FM-TV Wireless Record Player

Using just a basic record player unit, you can play favorite tunes through any type of set with this wireless oscillator



Wireless oscillator plays records through AM-FM radios and TV sets.

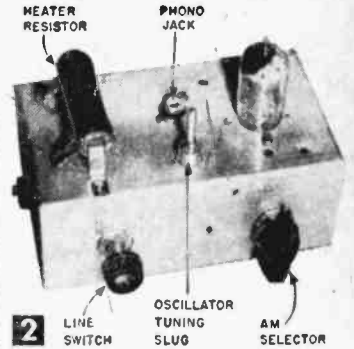

Oscillator chassis measures just $5\frac{1}{2} \times 3 \times 2\frac{1}{8}$ in.—small enough to fit in base of most record players.

MATERIALS LIST— WIRELESS RECORD PLAYER

- | No. | Description |
|-----|-------------------------------------------------------------------------------------------------------------------------------------------|
| 1 | aluminum box $5\frac{1}{4} \times 3 \times 2\frac{1}{8}$ in. or chassis formed from aluminum panel $5\frac{1}{4} \times 7\frac{1}{4}$ in. |
| 1 | line cord and plug |
| 1 | 9-pin miniature water socket |
| 1 | 12AT7 or 12AU7 twin triode tube |
| 1 | ICA phono Jack |
| 1 | radio oscillator coil (Stanwyc #212, or any other slug-tuned type) |
| 1 | FM oscillator coil (homemade from 1' length solid copper wire; #14 or #12.) |
| 1 | selenium rectifier rated 40 or 50 MA |
| 1 | Mallory #3222J 2-pole, 2-position non-shorting switch |
| 1 | S.P.S.T. rotary line switch and knob (toggle type may be substituted.) |
| 2 | rubber grommets; $\frac{3}{8}$ and $\frac{1}{4}$ in. |
| 2 | 50 mmf ceramic or miniature mica molded capacitors |
| 1 | 500 mmf ceramic or miniature mica molded capacitors |
| 1 | .01 mfd paper or molded type capacitors |
| 1 | 25 mfd electrolytic, 25 or 50 w.v., paper cased capacitors |
| 1 | 20-20 mfd dual electrolytic, 150 w.v., paper cased capacitors |
| 1 | 700 ohm, 20 or 25 watt wire-wound resistor |
| 1 | 27 ohm, 1 watt carbon resistor |
| 1 | 1000 ohm, 1 watt carbon resistor |
| 2 | 47K (47,000) ohm $\frac{1}{2}$ watt |
| 1 | 470K ohm $\frac{1}{2}$ watt |

Now you can play phonograph record music without wires through FM and TV sets with a continuous tuner, as well as your regular AM radio. You can also reproduce recorded music through turret-tuned TV sets that have separate "sound" I.F. systems by tuning the set to channel #6 with the fine tuner or turret oscillator slug adjusted to receive the record player's VHF signal. This unit will not work well, however, with "inter-carrier" TV receivers.

Although the circuit has been made extremely simple, record quality was practically as good via the wireless circuit, as when the record player's pick-up was connected directly to the receiver's amplifier except for the usual carrier signal present with full volume and no record on the machine.

Basically, the device consists of a modulated Hartley oscillator with a miniature twin triode tube (either a 12AT7 or 12AU7). Half of the tube functions as modulator; the other half as an oscillator. Because of the low current consumption of these miniature tubes, the heater is operated off the 115-volt ac-dc line

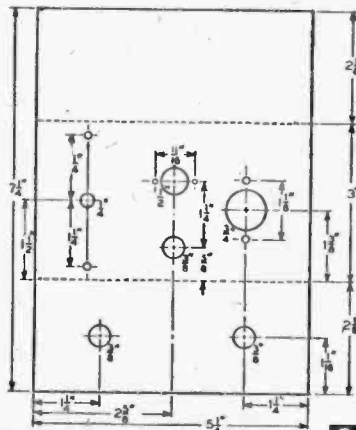

CHASSIS HOLE LAYOUT

through a 700-ohm, 20- or 25-watt resistor.

For a chassis, you can use an aluminum box $2\frac{1}{8}$ in. high, 3 in. wide and $5\frac{1}{4}$ in. long. Or, a U shaped chassis may be formed from a piece of #14- or #16-gage aluminum following the hole layout in Fig. 3. A chassis which does not exceed these dimensions may be installed within the base of most manual or automatic record players.

Two oscillator coils are switched into the circuit by means of a 2-pole, 2-position rotary switch. The oscillator coil for the AM band is an ordinary radio type stocked by all parts suppliers. There are three basic types as shown in Fig. 7: Feedback (4-lug) oscillator, Feedback with bifilar grid coupler (5-lug) oscillator, and the Hartley (3-lug) oscillator coil. You can use any one of these coils by connecting the lugs to correspond to numbers indicated in Figs. 5 or 6. While the original model used a 5-lug coil, we suggest the simpler Hartley type with slug tuner such as the Stanwyck #212. This coil snaps into a $\frac{3}{8}$ -in. hole and is identical in size to the 5-lug coil used in the original chassis except for the 3-lug hook-up.

The FM coil is homemade from #14 or #12 solid copper house wire from which insulation has been stripped. Two full turns are close-wound on a $\frac{1}{2}$ -in. dia. rod. Insert a penknife or small screwdriver blade in the spiral to spread the turns out leaving a $\frac{1}{16}$ -in. air gap between coils (Fig. 8). This coil compensates for internal capacity in the Mallory #3222J selector switch which was chosen because it is inexpensive, compact and readily available. Ceramic VHF switches are fine, but lack the virtues mentioned.

Install components that screw down with #4-36 or #4-40 machine screws and nuts according to Fig. 3. Mount selector and line switches, and snap AM oscillator coil in position. Before mounting the phono jack, in the $\frac{1}{2}$ -in. hole, insulate the exposed metal shell strips with Scotch plastic electric tape to prevent grounding the chassis into the circuit. The chassis should float free and clear of ground and is not only shockproof, but acts as an antenna to provide novel capacitance coupling. For additional range, secure a length of wire to the chassis.

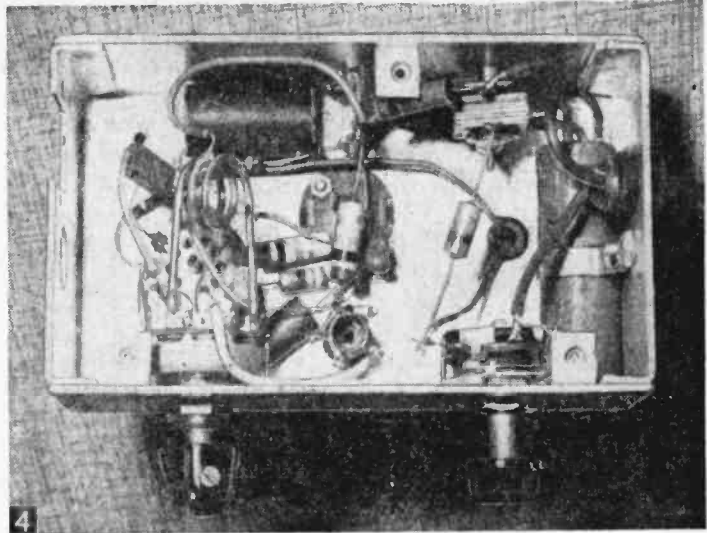

Underside of oscillator chassis shows plenty of space for wiring and components. Apparent crowding near center results from central grounding point to insure stable FM signal.

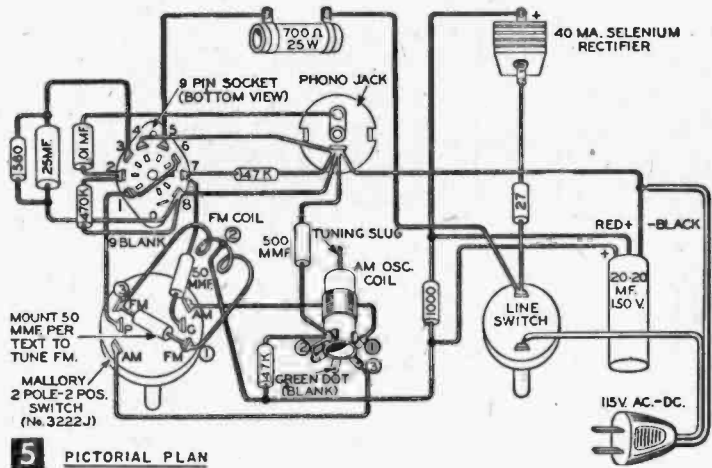

5 PICTORIAL PLAN

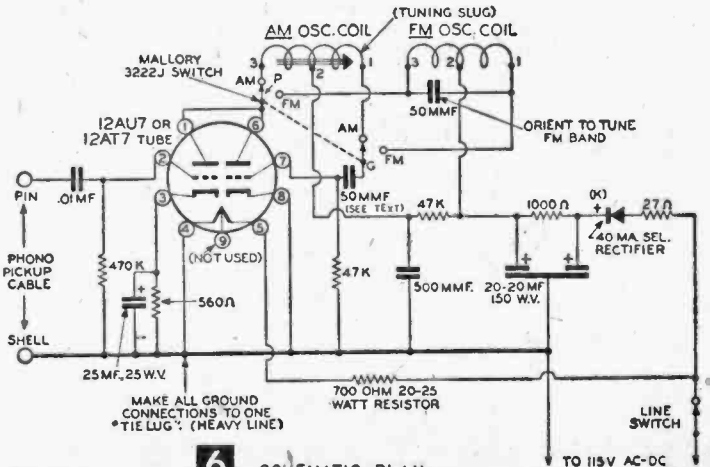

6 SCHEMATIC PLAN

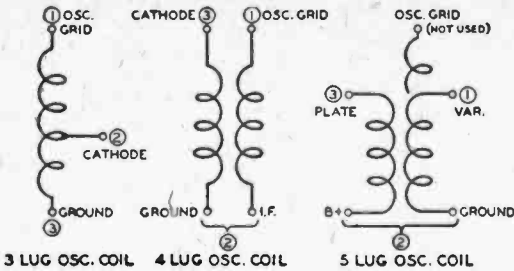

7 Types of AM radio oscillator coils. Use any one by connecting numbers to like points in the schematic diagram. If slug-tuned coil is not available, connect 250-*mmf* trimmer capacitor across lugs #1 and #3 for tuning AM band.

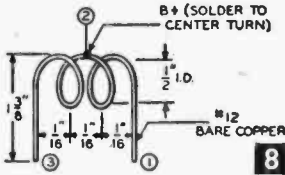

Left, FM coil—2 full turns wound on any 1/2 in. dia rod or stick. Space turns 1/16 in. apart.

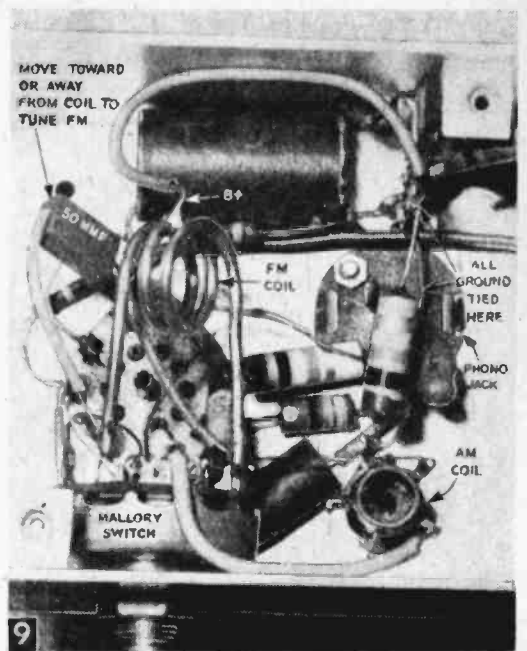

9 Close-up view of FM coil and the 50-*mmf* capacitor connected with its pigtail leads. This capacitor's position relative to FM coil tunes VHF circuit.

Wire in the various components, making the leads just as short as possible following Figs. 5 and 6. Leave your homemade FM coil and 50-*mmf* capacitor shunted across it until last. When possible, make all connections in the ground circuit (heavy line in schematic plan) at one or two junction points. An insulated tie-lug may be installed in the chassis for this purpose, although the outer lug on the phono jack may prove sufficient.

With major construction completed, test the AM section by plugging the phono pickup cable into the jack, setting switch to AM position and turning on line switch. Tune your AM radio to 1700 kc, put a record on the turntable and adjust the tuning screw on the AM oscillator coil until music is broadcast through radio.

Assuming your wiring is correct, but no music is obtained, the tuning slug of the oscillator coil may not produce enough flux density to tune between 1700 and 1600 kc. To correct this, connect a 100-*mmf* capacitor across the AM coil lugs #1 and #3.

Note that the FM coil leads have been cut to measure 1 3/8 in. To simplify soldering to FM switch lugs, tin the ends of the coil leads first, and at the same time solder a length of hook-up wire to the center coil turn for the B-plus tap. Solder coil to switch lugs neatly and firmly with coil clear of other components (Fig. 9).

Because you are working with Very High Frequencies in the FM range, tuning can be tricky. Instead of iron cores or variable capacitors a fixed midget mica or ceramic 50-*mmf* capacitor whose pigtail leads measure 1 3/8 in. long is shunted across the FM coil, being soldered to the same switch lugs (Fig. 9). This 50-*mmf* capacitor is positioned almost parallel with the plate end (P) of the FM coil (Fig. 6).

Turn on your FM receiver and tune to about 93 mc. Again play a record with your wireless

unit tipped on its side. With a plastic knitting needle, sip straw or any other non-metallic object, move the 50-*mmf* capacitor toward or away from the FM coil. The slightest shift in the capacitors' position will shift the signal from the low end to beyond the middle of the entire FM band. For maximum stability, position the capacitor to tune as low on the FM band as possible (about 92 mc).

A good starting point is to bend the pigtail leads so capacitor is 5/16-in. from the end of the coil. Now tune the FM dial until the recorded music is picked up. If the signal interferes with a regular FM station, shift the capacitor slightly and tune the set to the new frequency.

Once a suitable spot has been found on the FM dial, the wireless unit requires no further attention for recorded music will always "tune in" at the selected frequency. Once positioned, any good quality ceramic capacitor will remain rigid. Should music drift off its predetermined frequency it's likely the pigtails are not of standard wire gage to insure rigidity.

When making initial tuning adjustments both for AM and FM, this unit should be placed near the receiver to insure maximum signal reaching the radio. An external lead may be secured to the chassis to act as an antenna when wireless record player and receiver are some distance apart. This need be just a few feet of fixture cord for AM and a foot or so (if anything) for FM. Reverse the line cord in outlet if necessary to correct polarity and obtain best signal.—END



1 Mounted in a plastic jewelry box, this powerful one-tube all-electric radio sets a record for compactness. The .117L M7 tube serves as both screen-grid detector and rectifier.

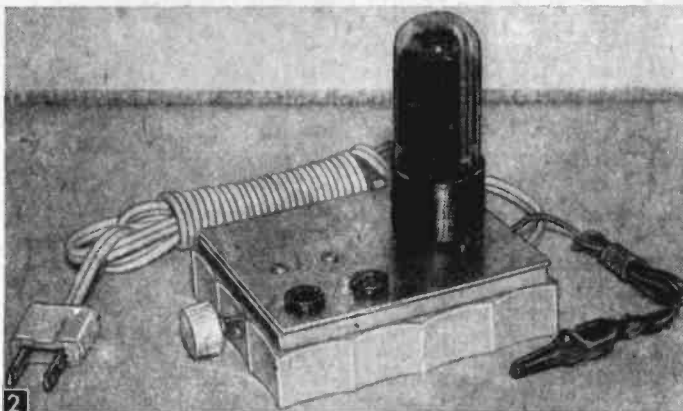

2 Split-hair tuning is provided by micrometer knob at left. Phone tip jacks are located on panel with line cord and antenna clip lead through hole in back of plastic box.

Mite-Size Radio

Although intended primarily for earphone listening this tiny set has enough built-in pep to operate an 8-in. PM speaker!

THIS all-electric personal radio, with tube removed from socket, measures only $3\frac{5}{8} \times 3 \times 1$ -in. deep. All parts are standard types working in a unique super-regenerative circuit which provides exceptional sensitivity and volume. While designed for headphone use, it produced good volume on local stations when tested with an 8-in. PM speaker, and 2500-ohm output transformer attached to phone jacks (Fig. 3).

An outdoor antenna is not necessary unless you plan to use the set in rural areas distant from the larger stations. Even then, 50 ft of antenna should be enough. We found 6 ft of wire sufficient for local reception, with a bed-spring or an aluminum window screen ample for more distant reception. By setting a dial phone on a small square of aluminum foil, then attaching the antenna clip lead to the foil, volume proved excessive for earphone listening.

Although the set shown here has been reduced to minimum dimensions, you may spread out the assembly to use even a cigar box to house the set. The pictorial wiring plan (Fig. 5) applies regardless of dimensions, however, when duplicating the size set shown. Arrange the aluminum panel layout to match the specific components obtained from your local or mail-order parts dealer—select the smallest physical size electrolytic capacitor in his stock. The Bakelite box used with the original set was a gift box obtained from a jewelry store. The transparent acetate cover furnished with the box was discarded, but if you can buy an all-

Bakelite box the lid may be used as a panel by carefully drilling the necessary mounting holes. Use either a "fly-cutter" or hand-grinder tool to make the 1-in. socket hole.

In any case, make a $\frac{3}{8}$ -in. hole in one end of the box to clear the screw feed of the tuning coil, and a $\frac{1}{4}$ -in. hole in the opposite end of the box for the fixture cord and antenna clip leads. A plumber's type pipe reamer is an excellent tool for enlarging holes in plastic. Merely drill a small hole large enough to pass the tip of the reamer, then make back-and-forth twists.

MATERIALS LIST—MITE-SIZE RADIO

- 1 ferrite-tuned antenna coil (Miller, Stanwyck, Grayburne, etc.)*
 - 1 homemade knob to fit screw shaft of antenna coil
 - 1 octal tube socket
 - 2 radio phone tip jacks (Amphenol, Eby, ICA)
 - 1 pc. #14 aluminum $3\frac{5}{8} \times 3$ -in. (or larger)
 - 1 Bakelite box
 - 1 6-ft fixture cord and plug
 - 1 single or double headphone, 2000 ohms
 - 1 battery clip
 - 1 117 L/M 7 GT tube (combination half-wave rectifier & power pentode)
 - 1 20 megohm $\frac{1}{2}$ -watt resistor (18 or 22-megohm, optional)
 - 1 3300 ohm $\frac{1}{2}$ -watt resistor
 - 1 18K (18,000) ohm 1-watt resistor
 - X 1 100, 180, or 220 mmf ceramic, or mica trimmer 220 mmf capacitor, (see text)
 - 1 50 mmf ceramic type, capacitor
 - 1 .005 mfd mica or paper type capacitor
 - 1 .001 mfd mica or paper type capacitor
 - 1 cardboard dual electrolytic capacitor; 20-20 mfd—150 working volts
 - Misc. hook-up wire and mounting nuts and bolts
- * Exact coil with 180 mmf capacitor knob and lock-nut included available from Electro-Mite, P.O. Box 636, Dept. SM, Springfield, Conn., for \$1.25

The compactness and sensitivity of this set are the result of the circuit design and the ferrite-tuned coil, combined with the automatic "feed-back" control provided by the .005 mfd capacitor in the plate output circuit. It is possible to obtain further sensitivity by reducing this capacitor to .004 mfd, but at frequencies from 550 to 680 kc, the set may howl.

The tuning coil consists of 12 ft of Litz coil wire wound in progressive lattice manner on a 1/4-in. I. D. paper-base Bakelite tube. A 1/4x1 1/8-in. ferrite core within the coil form provides the tuning device. The core is moved with micrometer accuracy by means of a #4-40 brass screw to which a screw-on knob and lock-nut is attached.

In order to tune the broadcast band, the coil is shunted with ceramic capacitor "X." For stations from 1600 to 900 kc, this capacitor may be about 100 mmf. To tune from 900 to 550 kc, 220 mmf should be used; or a 180-mmf unit may be selected with coverage from about 1350 to 700 kc. The value you select depends upon stations operating in your community.

You may, if space permits, use a 220-mmf mica trimmer which may be adjusted with a screwdriver to cover any part of the broadcast band. In this case, drill a hole in the bottom of the case to gain screwdriver access.

The tuning coil is provided with a snap-mount which fits a 5/16-in. hole. In this set, we mounted the coil on a small bracket parallel with the chassis. However, where space is no factor, the coil may be installed vertically in a 5/16-in. hole drilled in the set panel.

Although no power line switch was provided on the original set, there is ample room for a small rotary-type lamp switch as sold by hardware, variety and electrical supply shops. Moreover, instead of a conventional piece of fixture cord, a TV interlock cord may be used with an interlock socket attached to set (available at radio houses). With this arrangement, the fixture cord may be disengaged from radio.—END

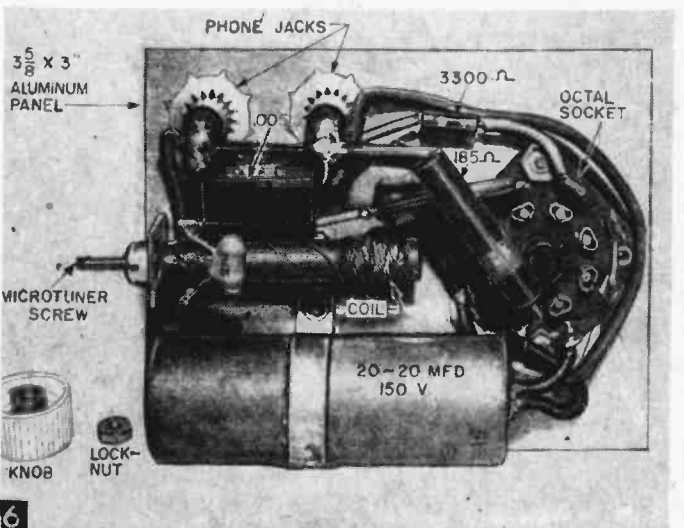
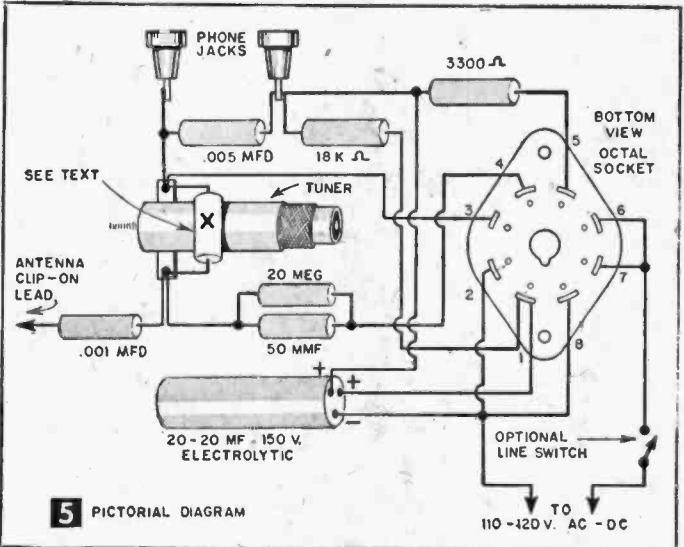
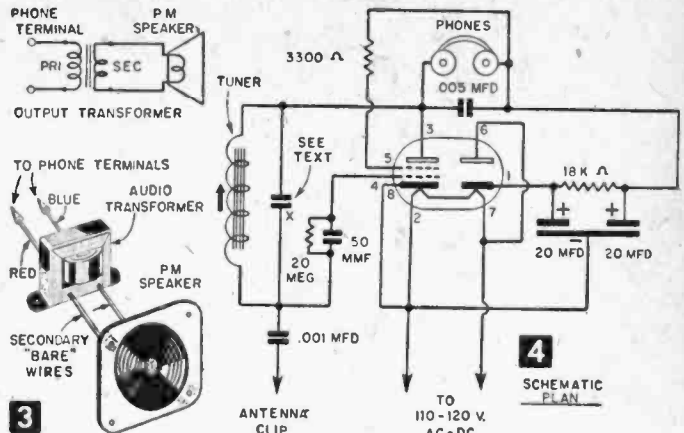

Bottom view of vestpocket electric radio. Line cord and antenna clip lead are soldered in after all wiring has been completed.

You'll be sure to catch your favorite
TV and radio programs on time,
and enjoy improved sound,
with this compact

TV-AUDIO TIMER

AFTER missing a particular TV program two weeks in succession, I decided to operate the set with an electric timer clock which would turn it on automatically should my memory again fail me. I also inserted a small PM speaker in the cabinet with the clock to pick up the higher audio frequencies often lost by the 10" and 12 in. PM speakers employed in radio and TV consoles. I found that the unit produces a diffusion of sound and makes a set with a single large speaker sound better.

The finished outfit cost less than \$8. This included the cheaper of two Sessions clock mechanisms which is designed to turn on any electrical device (up to 15 amps) at any predetermined time, and shut it off 90 minutes later. A deluxe model is available which will perform both predetermined On and Off functions. Wiring is the same for both models.

The minimum dimensions of the cabinet used in this project and the use of a 4-in. PM speaker to serve as the "tweeter" make it necessary to locate the speaker in the side of the cabinet. For more even sound distribution, it might have been better to have mounted the speaker in the front or the top of the cabinet. Although side-mounting is satisfactory, you can use a 3-in. PM speaker in this box, or use a larger cabinet.

Use a "flycutter" or keyhole saw to cut the circular cabinet openings (Fig. 1). The size of the speaker opening will depend upon size of the speaker: a 3½-in. hole for a 4-in. PM speaker; 2½ in. for a 3-in. PM

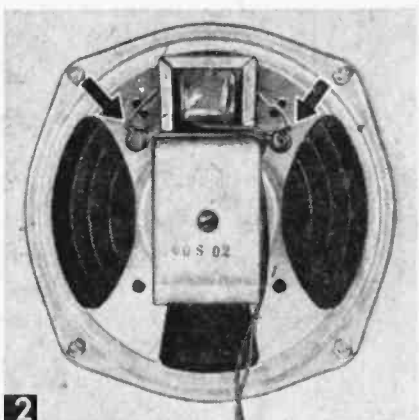
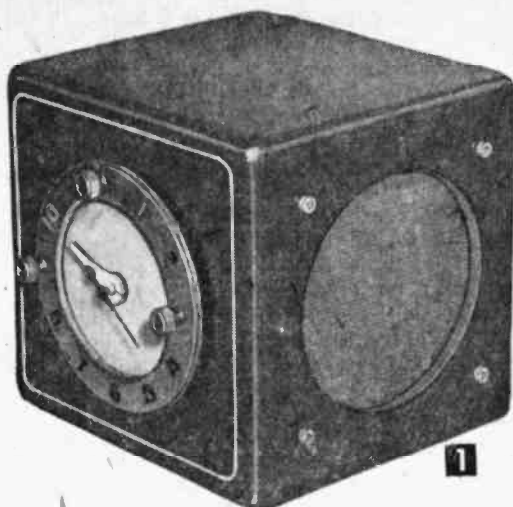

Connect clock speaker to TV or radio console speaker by attaching clips to lugs indicated in photo by arrows.



Left hand clock knob of audio timer is for setting alarm; right hand knob sets clock hands. Top knob is automatic and manual On-Off switch. Set TV or radio volume level with power switch always in On position.

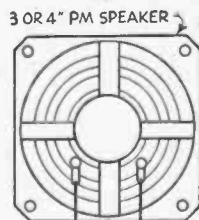

CLIP TO LUGS ON TV OR RADIO SET SPEAKER

CLOCK ESCAPEMENT SYNCHRO MOTOR ROTOR

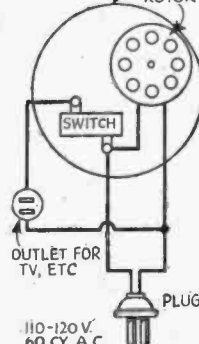

110-120 V.
60 CY. A.C.

BOTH UNITS MOUNTED
IN SMALL WOOD
INTERCOM BOX

Rear view of speaker-timer mounted inside a 5½x5¼x5-in. cabinet. Back was cut from acoustical tile board.

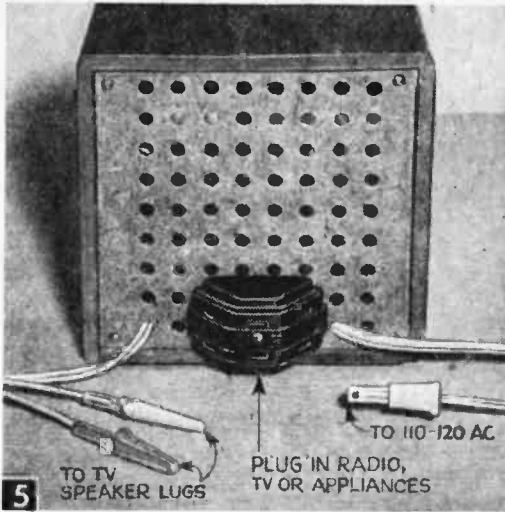

5 Bakelite outlet permits plugging-in TV, radio and other devices.

MATERIALS LIST—AUDIO TIMER

- 1 wood "Intercom"-type cabinet, 5x5 1/2 x 5 1/4" or larger
 - 1 Sessions Clock Timer* (Sessions Clock Co., Forrestville, Conn. Mfrs.; available from radio parts houses)
 - 1 Bakelite surface mounting outlet
 - 1 3 or 4" PM speaker
 - 1 4x4" metal or cloth grille
 - 1 6' line cord and plug
 - 1 4' fixture cord
 - 2 alligator clips (small)
- * Model W-26 has automatic "turn-on" feature. Model W-31 has both automatic "turn-on and off" feature. Both timer movements available with either a round or square face.

Cut a 3 3/16-in. hole in front of the cabinet for the clock. The mounting flange and bracket included with the clock mechanism can be modified as was done here.

Before installing clock and speaker, make connections as shown in wiring diagram (Fig. 3). Ordinary fixture cord may be used for both clock and speaker lines. Attach about 4 ft. of "zip" cord to the speaker lugs (note that no extra output transformer is used). Fit the ends of this cord with small alligator clips for connection to the lugs on the TV or radio speaker (Figs. 3 & 4). The clip connections allow the timer to be quickly removed for any number of household tasks.

Wire the clock mechanism to the fixture cord, using as the TV outlet an inexpensive Bakelite surface receptacle such as is sold in dime stores. The one shown here has three outlets so that not only radio or TV but additional devices such as a tape recorder, can be plugged in (Fig. 5). **Caution:** Do not exceed the rating of the switch in the clock when plugging in such devices.

Since "intercom" cabinets do not include back-plates or covers, make one from a piece of scrap acoustic tile, plywood, pressed caneboard or even heavy cardboard. For the speaker grille, use a piece of perforated aluminum, or cloth or metallic woven grille cloth that is stocked by most regular radio dealers.—T. B.

BIGGEST BARGAINS FOR BEGINNERS!
from **WORLD RADIO LABS**

WRL'S FAMOUS BANDSWITCHING GLOBE SCOUT TRANSMITTER



Only \$7.95 per Mo. \$10 DOWN AND 12 MOS. TO PAY

COMPLETE AMATEUR RADIO KITS FOR THE NOVICE!



RECEIVER \$14.70 Complete Stock No. 75A008
TRANSMITTER \$29.40 Complete Stock No. 81A052

This 65 watt, complete bandswitching Globe Scout is ideal for beginners. Compact: 8"x16"x8" case and operating 160 thru 10M. Pone and CW. PI Network antenna tuner. Fully TVI screened cabinet. Send for complete information today!

Stock No. 1000A020W

Build your own transmitter and receiver and "go on the air" with this complete kit and simple instructions. Complete kit only \$43.22. Designed for single wire antenna. Power supply included with transmitter. Units may be purchased separately. Write for full details.

World Radio Laboratories is the world's largest distributor of amateur radio and electronic equipment... over 15,000 items of the latest design on the market, including WRL's own famous 500 watt, completely bandswitching Globe King, that can be yours for only \$36.78 per month! Write today for our new FREE catalog, showing our entire list of items for the novice and the Professional. It's easy to do business with WRL.



FREE! 1955 CATALOG

Your Permanent Guide To Over 15,000 Top-Value Items!

SEND FOR IT!

- ★ Only 10% down payment
- ★ "10 Day Free Trial" Plan
- ★ More Money-Value for Trade-ins
- ★ Over 600 Bargains in reconditioned transmitters, receivers, etc.

WORLD'S MOST PERSONALIZED RADIO SUPPLY HOUSE



WRITE - WIRE - PHONE 2-0277 COUNCIL BLUFFS, IOWA

Address To: WRL—BOX 811—CO. BLUFFS, IA.

Please Quote Trade-In Value of My:

RTV-51

(Make and Model of Equipment)

On Your

(Make, Model Equipment Desired)

- Send Free Catalog! 3"x4" Radio Map (25c). Full Information on Globe Scout, Amateur Radio Kits, Reconditioned Equipment, Globe King, E-Z Pay Plan, to:

NAME

ADDRESS

You Can Fix That Ailing Radio

Modern table sets are easy to repair once you know where to look for the trouble. Here are the cures for the majority of dead or sick small sets!

WHO doesn't own—or know someone who owns—a small radio set that has gone dead, has become noisy or plays intermittently and is not repaired because the owner figures it isn't worth a stiff repair bill. Actually, because of the simplicity and basic uniformity in design of all small ac-dc radios, there is no reason why you can't take on the job of fixing that ailing set!

Let's get rid of the idea that elaborate test instruments such as signal generators, vacuum tube voltmeters, ohmmeters, or tube testers are required. Chances are you can locate the trouble and make the repairs needed with the tools you have, and you don't have to be an electronics engineer to repair a small radio—any more than a garage man must be an automotive engineer to replace a distributor condenser.

From the following check-list you can find the symptoms and probably the cure for most small radio failures. So long as you have not tampered with the capacitor screws in the I.F. transformer cans, or the trimmer screws on the set's tuning condensers, the check-list enables you to methodically track down the cause of any small set's failure to play. If, however, you have tinkered with the above adjustments, you'll have to take the set to an experienced radio technician for the cure.

To remove the chassis from the wood or plastic cabinet, first remove the knobs, which are secured to tuning shaft and volume control either by set-screws you can loosen, or, in more recent sets, merely pulled off the shaft. These pull-off knobs are secured by spring-blade tension, or knurled friction grooves. The chassis is secured either by screws under the cabinet, or by screws inside the cabinet, revealed after the back cover or loop antenna is removed. When you remove these, chassis slides freely from case.

Check all tubes first on a tube-tester at the radio store—usually there's no charge. Or use the pocket size tube checker presented on page 86 of this handbook. You'll need a neon bulb



DIFFICULT TUNING. Slipping dial cord produces backlash. Apply mixture of 1 drop thick bone glue mixed with 1 drop glycerin to cord shaft of dial drive (See 1, Fig. 3). Or take up slack in dial cord caused by wear.

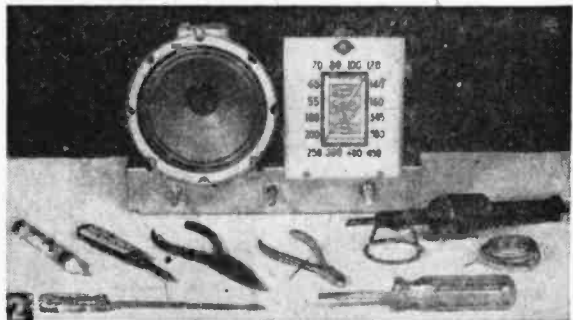

TOOLS. You need only a penknife, long-nose and diagonal "cutter" pliers, small soldering iron, 50-grade solder, small and medium blade screwdrivers for repairs. Dry graphite lubricant used on shafts.

continuity test set with two leads to check on capacitors, resistors and coils. After disconnecting one side of a suspicious component with a soldering iron, connect the clip and probe leads as shown in Fig. 7.

A broken wire, open resistor, or open capacitor will result in the neon lamp not glowing. The



Rear view of typical ac-dc set removed from cabinet. Ultra-modern sets compare with this layout except for smaller tubes, I. F. transformers, tuning condensers; and ferrite "stick" antenna.

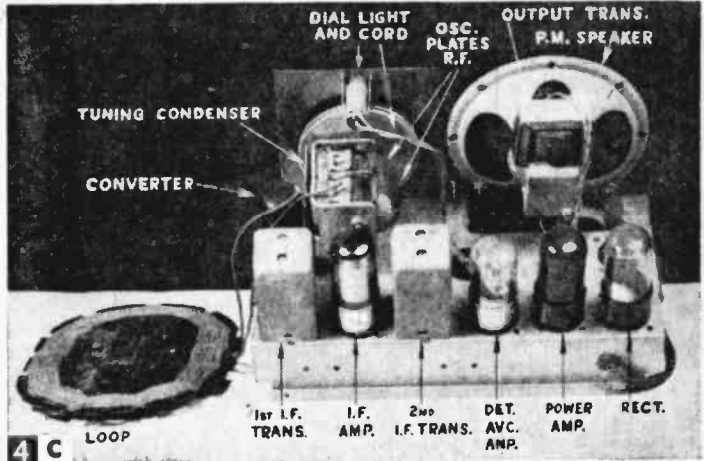

.01 mfd. between plate of the 12SQ7GT (or 12AT6) and grid of 50L6 (or 50B5-50C5). Replace with new capacitor of value similar to original unit. (See C, Fig. 3)

Resistor, capacitor, wires, etc. accidentally touching chassis, or a cold solder joint often silence a set. Look for these small, but troublesome defects.

Check line cord for invisible breaks between set and plug. Be sure the outlet is not defective, nor that the trouble in the set is simply due to a blown line fuse. Check oscillator coil, and I.F. transformers for open in a coil winding. (You'll find that this is a rare condition, however.)

Noise. *Very Loud Buzz*, music scarcely audjble. Defective electrolytic capacitor, or bad rectifier. Replace one or both. (See D-DD, Fig. 3)

Scratching noise while tuning set. Accumulation of dirt between the stator and rotor plates. Blow and/or brush out dirt. Small pipe cleaners are helpful in dislodging grime. Be sure no tuning capacitor plates touch each other. The phosphor bronze spring which grounds rotor plates to frame may be worn and dirty. A few drops of lighter fluid will dissolve the grime. If spring is excessively worn, solder a flexible "pig-tail" from rotor shaft to condenser frame to silence the scratching noise.

Scratching noise on volume adjustment. The 500,000 ohm potentiometer is worn out and requires replacement. In some instances where the back of this control is removable, a few "shots" of graphite lubricant will restore the control to good condition. Deposit graphite on "horse-shoe" element inside control. (See E, Fig. 3)

Hollow, bell-like ring or howl. A "microphonic" tube often shows no defects when tested even on a costly tube checker. Locating a tube of this nature is done with radio playing, volume turned low so speaker does not vibrate the faulty tube. With the rubber head of a pencil, ever-so-gently tap the glass envelope of each tube. Tapping the bad tube will create the howl. The slightest vibrations will carry over from a tube that is perfectly good to the culprit causing a false indication unless tubes are tapped gently.

Dirt in speaker voice coil. Most speakers are provided with a felt washer, or dust cover, to keep foreign matter from fouling the free movement of the voice coil. A set with distorted reproduction may have its cause in dust cover dropping off. Blow out all dirt and cement cover to speaker cone with a quick drying cement.

Defective Dial Lights. Broken or frayed dial

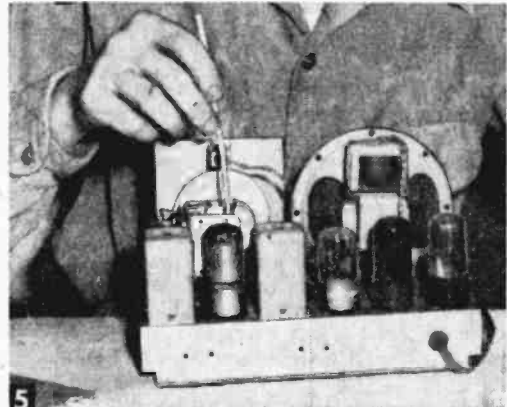

Dirt in gang tuning condenser plates is removed with thin pipe cleaners, aided by brush and blower. Check for rubbing plates.

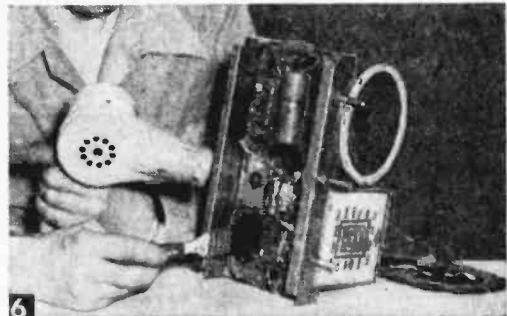

After removing chassis from cabinet, brush out all dust. Blower or vacuum cleaner exhaust help in expelling accumulated grime.

light leads, loose sockets, or dirty lamp contacts, often create a racket as soon as volume is turned up. Clean and repair any defects found.

Other noises. Most small sets have a .05 mfd. capacitor across the line cord terminals to reject as much power line interference as possible. (See H, Fig. 3) Vacuum cleaners, electric drills and

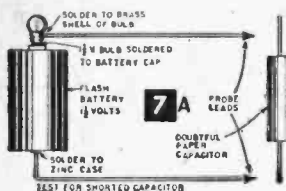
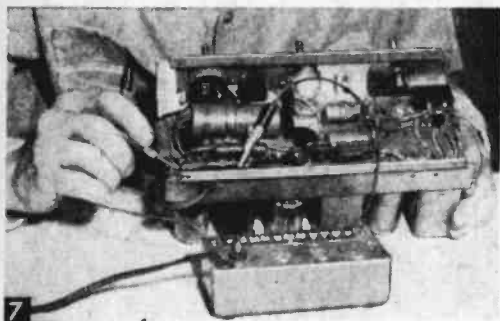

Continuity tests are made with neon test bulb of pocket tube tester. It reveals defective resistors and capacitors. Left, flashlight battery test for "shorted" capacitors.

hand-grinders, shavers, hair-clippers, and magnetic contactors in oil-burners, motor starters, etc., create most man-made interference. Other interferences stem from X-ray machines, and arc welders or diathermy machines.

Intermittent Set Failure. In this group are the sets that play fine one minute—get weak, or go dead, the next. These intermittent conditions are not as difficult to locate as would be expected. Here are most of the causes:—

Check line cord for internal breaks by bending cord back and forth every few inches.

Speaker vibration causes wires or component leads to momentarily short against chassis. Also check for loose or broken lead from set to the loop antenna.

Defective grid return capacitor in first I.F. (12SK7 or 12BA6) or diode detector, AVC tube (12SQ7 or 12AT6). This capacitor is usually about .05 mfd. This symptom can usually be identified when set gets loud or soft as a light switch is snapped on or off. (See F, Fig. 3)

Intermittent audio coupling capacitor. (Previously described under *Receiver Dead*.) Instead of remaining open permanently, capacitor may have a thermal action caused by temperature changes. Replace if at all suspicious. (See B, Fig. 3)

Cathode Resistors and By-Pass Capacitors. Because of the low voltages required to operate ac-dc sets, only the cathode of the output tubes (50L5, 50B5 or 50C5) employ a current limiting resistor.

Sometimes the original resistor is too small to handle the current load. Replace with new 150-ohm resistor rated one-watt. (See G, Fig. 3)

Console type sets and deluxe table sets having power transformers to deliver higher circuit voltages, may employ several tubes having cathode resistors and by-pass capacitors. In these receivers, the cathode resistor is usually of ample wattage to handle the cathode current. However, the by-pass capacitor across these resistors is expendable. Check in particular the low voltage 5 to 25 mfd. electrolytic capacitor across the detector tube cathode resistor. In some sets this may also be a paper capacitor of .05 or .1 mfd. Defective by-pass will cause set to go from loud to soft and back again.

Dirty socket contacts or tube pins. Clean underside of chassis with a new paint brush to remove all dirt. If socket contacts are sprung, crimp each one slightly with long-nose pliers to insure firm pin grip. If socket contacts are dirty inside, clean with pipe cleaner dipped in carbon-tetrachloride, or lighter fluid. Look for "cold" solder joints on socket lugs. More poor-connections occur on socket lugs than anywhere. Resolder all suspicious connections.

Grid resistors. These rarely cause trouble because of the very minute currents that pass through them. However, careless installation at the factory may cause a broken lead or cracked plastic jacket. Inspect all resistors for damage. Faulty resistors usually appear burned because they have been required to pass more current than their rating allows. If color code bands painted on resistor are scorched, replace the resistor with same ohms value, but double the watts rating of old part. Makers of low cost, mass produced midget ac-dc sets often sacrifice properly rated components in favor of a low price tag.

The above tabulation of receiver troubles should solve most of the troubles that interfere with top radio reception. There is now the matter of replacement parts. Suppose you ask a

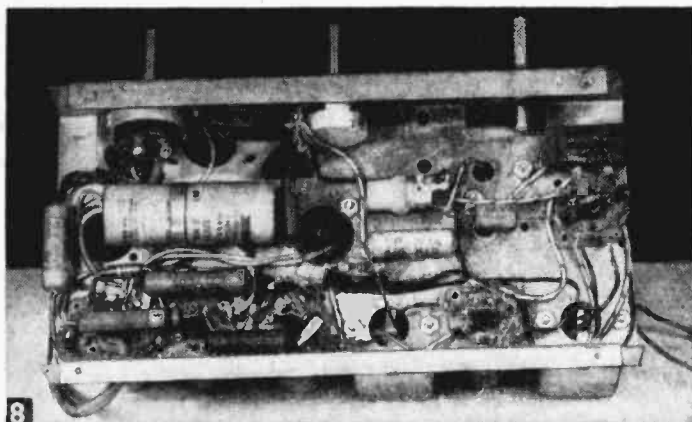

Actual bottom view of a 5-tube ac-dc superhet shown in Fig. 3. Note that photo and pictorial plan are identical. Not all sets are wired as neatly.

parts supplier for a 50,000-ohm resistor because that was the value of the defective part removed from the set. He says, "Sorry, nearest I've got is 47,000 ohms." Fine, use it! It is safe to say that any resistor in a radio receiver may be varied at least 20% in either direction if the resistor value is over 5,000 ohms.

However, never accept a replacement for a low-ohm resistor if it is more than just a few ohms more or less than original. Making a radical resistance change in a low-ohm value can do two things: render the set inoperative, and/or burn up one or more components in the circuit to create a real repair problem.

For example, many pee-wee ac-dc sets employ but four miniature tubes; two 12v. tubes, one 50v., and one 35v. tube. The total series filament voltage is 109. As most utilities deliver between 115-125 volts to the home, these tubes would quickly burn out with no line-drop resistor in series with power line. Therefore, a 73-ohm 1.65-watt (minimum) series resistor is needed if line voltage is 120.

First, there is no 73-ohm value, nor a 1.65-watt resistor. What do you do? The radio supplier may have a 75-ohm unit which is rated at 5 watts. A slightly higher resistance value is better than a lower one, so use it! Moreover, the 5-watt rating insures a cool-running, long-life resistor. Always strive for a replacement part with a higher wattage rating than the original, and a slightly higher resistance (rather than lower) than original if exact match isn't available.

If the parts supplier in your town isn't so well stocked, he will at least have 39-ohm, 2-watt resistors as this is a standard RTMA size. Connect the two 39-ohm resistors in series making a total resistance of 78-ohms, and you're in business!

Where you may desire some exact value, you can always connect any number of resistors of like wattage in series to provide the total ohms needed. Example: 33,000 and 56,000-ohm resistors connected in series make up an 89,000-ohm resistor, etc.

If a resistor of 2700 ohms, 2 watts is required, and your supplier has 1-watt sizes only, there is

also a solution. First multiply the value of original resistor by two. This makes 5400 ohms. The nearest standard value will be 5600 ohms. Therefore, buy the two 5600-ohm, 1-watt units, and connect in parallel. Resistance will now be 2800 ohms, 2 watts—well within the circuit's requirements.

Capacitors do not present the critical condition which often exists with low-ohm resistors. Here, there is rarely any noticeable effect in reception by a wide variation in the value of a paper capacitor, or a modest variation in small mica or ceramic type capacitors. A larger or smaller value than specified won't harm the set.

With capacitors, it must only be remembered that if the unit is of the electrolytic type its polarity must be observed. That is, never install a new unit with *plus* where *minus* lead was originally connected, or the reverse. Make a note of the defective condenser's position before removing for replacement.

Paper, mica and electrolytic capacitors usually carry a *working voltage* rating. The higher the working voltage, the more these components cost. Now, in the case of an ac-dc set as shown here, no capacitor need be rated higher than 150 w.v. Larger receivers (those with power transformers) will have capacitors rated 400 or 600 w.v. Usually these data are printed on the capacitor jacket. Always replace with 600 w.v. units if this information is unknown.

With paper capacitors it is better—but not absolutely essential—to replace defective units with observance to the "outside foil" marking being the side of capacitor connected to ground. A black band around one end of paper capacitors also indicates "outside foil" lead.

Summing up, most small radio troubles are quickly discovered if the conditions experienced are compared with the trouble chart, and the component located on the typical chassis layout shown in accompanying illustrations.

From long experience, it has been found that defective tubes, resistors, and faulty capacitors lead all other radio troubles. Fortunately, these repairs are usually the simplest to make.

Mounting Coil Forms on Chassis

RADIO experimenters like to use *Cellu-plastic* or *Styron* containers for coil forms because they are cheap, come in many different sizes and have low-loss characteristics.

In cases where a coil is to be installed permanently, simply bore a hole of the required size through the bottom of the container and through the chassis, and then insert a rubber grommet to hold the two units securely together. The rubber grommet also serves as an insulated bushing for passing the coil leads through the chassis. Rubber grommets are available in many different sizes, and with different slot widths, so you should have no trouble finding the right size grommets for containers and chassis.—A. TRAUFFER.

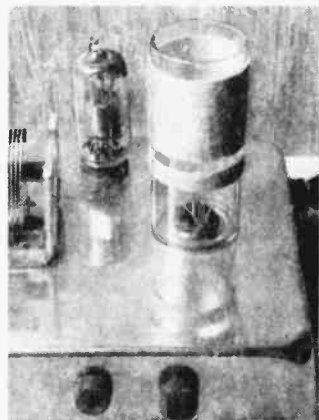
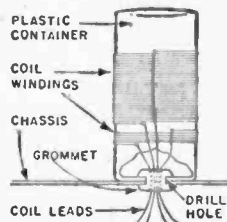

Converting Your TV to Receive UHF

Here's the information on how to install your UHF TV set or convert your present VHF set so that it can receive UHF telecasts



Converter (on top of cabinet) works with all TV sets, requires no circuit alterations and tunes all 69 UHF channels. Unit must be placed as close to set antenna-terminals as possible. Tuning adjustment is very critical for sharp picture.

WHEN the FCC extended the TV spectrum into the Ultra-High Frequencies (UHF) it was to provide the smaller U. S. communities with television reception equal to that offered by the Very-High Frequency (VHF) stations around large cities.

In most of the areas where UHF first made its bow, everything from TV station to home receivers developed all sorts of technical bugs. Most of the transmitting problems were cleared up in a matter of weeks. However, many sets converted to receive UHF are still limping along with just mediocre to fair reception.

Poor reception is due mainly to a combination of poorly installed antennas and/or maladjusted UHF converter systems. In areas already served by distant VHF stations, UHF installations were most disappointing. In these spots UHF antennas were merely clamped to existing masts. Sometimes sepa-

rate lead-ins were provided or just connected to the existing VHF antenna with a jumper. Lead-ins were often allowed to come in contact with metal roofing, gutters or leaders.

To insure top television reception, follow these installation tips:

THE TV RECEIVER.

If you already enjoy TV on channels 2 to 13, your present set can be converted to receive UHF channels 14 to 83. Sets with a turret type tuner may be converted to receive from one to six stations, as many as will ever operate in your territory. Sets with switch type tuners require an external converter (Fig. 1) which provides continuous tuning of all UHF channels. You can also use the external converter with a turret tuner instead of changing the strips in the tuner.

CHANNEL STRIP CONVERSION. This system is least expensive and, after changes are made, easiest to

operate. For sets equipped with a Standard Coil turret tuner, remove any pair of strips on the drum where no station is received.

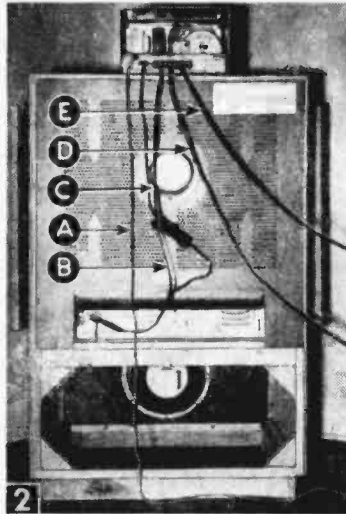

Built-in switch turns on converter and TV set and selects UHF or VHF antenna in areas where both types are available. Cables left to right are: (A) Converter power cord, (B) TV power cord plugged into converter; (C) Converter-TV set coupling; (D) VHF antenna and (E) Oval UHF antenna far right.

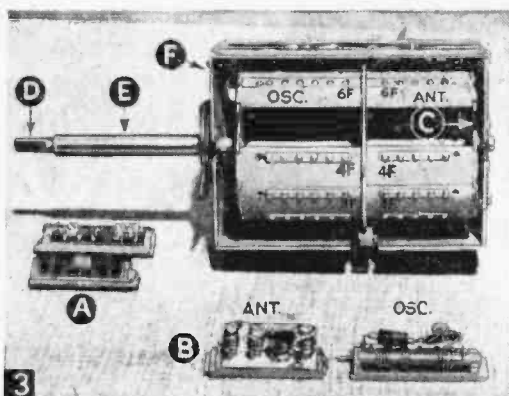

Standard turret tuner used in many TV sets. Any unused pair of VHF channel strips (A) may be removed from tuning drum and replaced with UHF converter units (B) which automatically tune-in any one channel. Additional strips may be added for other UHF stations. (C) Coil board retaining springs. (D) Channel selector shaft. (E) Fine tuning sleeve. (F) Hole for oscillator adjustment. Remove selector plate from front of cabinet and use all-plastic screwdriver.

The coil boards, as they are often called, may be lifted out by slipping a penknife blade under the retaining spring at each end of the drum (Fig. 3).

Note the letter printed after the channel number on each strip, for example "F". Suppose you desire to receive UHF channel 27. Merely ask your local or mail order parts supplier for a set of Standard UHF coils type 27F. The present VHF strips in your turret tuner may be labeled F, G, K, Q, R, H, M, or U. Be sure to give the tuner's correct serial letter as well as UHF channel desired. For tuners with the letter M on the VHF strip the correct UHF strip will have the letter R stamped on it instead of M. All other strips have the same letter for both the VHF and the UHF strips. While all Standard tuners may look alike, they vary electrically and mechanically.

Earlier Standard tuners had exposed tuning drums. More recent models feature a snap-on shield cover that lifts off with a gentle pry at the front end of the assembly.

INSTALLING UHF STRIPS. When you receive the pair of UHF

channel strips, remove their protective cellulose packing very carefully so as not to disturb the coil spacing or position of crystal diodes and other components. Insert the long oscillator strip into the front section of the tuner. Be sure it snaps firmly into position with the grounding strip in contact with the side of the center (Fig. 3) scalloped detent disc.

Next insert the short antenna strip. Make sure the tiny silver pin in the oscillator strip and connecting sleeve on the antenna coil mesh properly before snapping the antenna coil home. That completes the set conversion except for putting up the antenna.

Some Zenith or RCA sets use their own turret-type tuners and require UHF coils available only through their dealers or service organizations. The radio experimenter may find it more economical to use a converter with these sets, getting full 14 to 83 channel coverage. The converter would cost little more than service and strips for one channel when done by a commercial organization.

INSTALLING A CONVERTER.

A UHF converter consists of a tuner and frequency changing circuit that uses one of the present VHF channels as the Intermediate Frequency (I.F.) for the incoming signal. Some converters

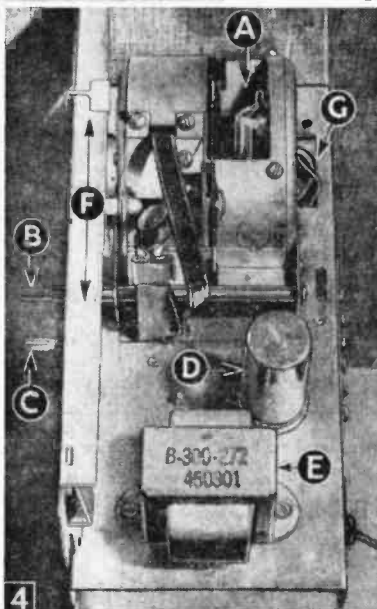

Top view of a quality converter. Both oscillator and I.F. Amplifier tubes are located inside tuning drum. (A) While power supply and switching mechanism can be serviced locally, any defects in tuner must be corrected at the factory. (B) Tuner shaft. (C) Switch shaft. (D) Filter capacitor. (E) Filament and power transformer. (F) Slide dial plate. (G) Output coupling adjuster.

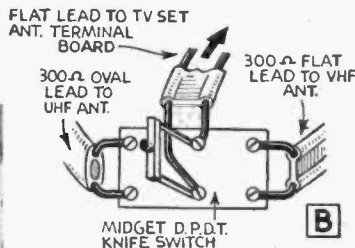
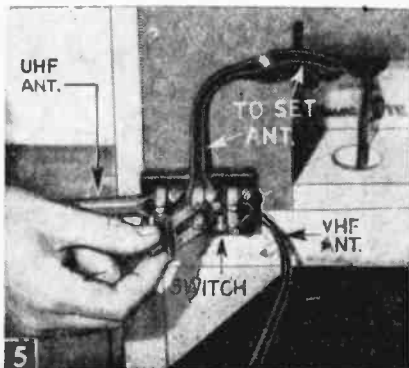

(A) A Midget D.P.D.T. knife switch attached to rear of set changes from UHF to VHF antenna when both types of stations operate in your area. Required only for strip conversions of turret tuners coil strips. Not needed with many converters, nor where only UHF is available. (B) Hook-up of knife switch for UHF-VHF change-over.

UHF ANTENNA SELECTION GUIDE

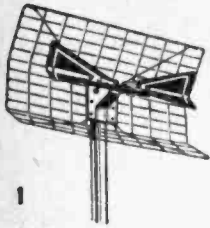

1

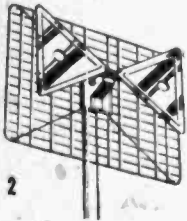

2

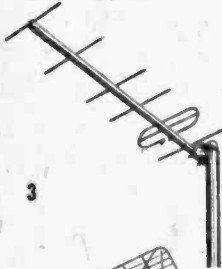

3

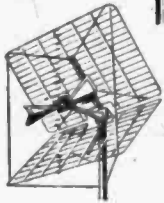

4

1. **MODIFIED CORNER REFLECTOR.** A cross between the conventional bow-tie and corner reflector UHF antenna. Tunes all channels, and has somewhat more gain than bow-tie antenna. May be stacked for greater signal pick-up.

2. **BOW-TIE.** The all-around UHF antenna. Pre-assembled design, lightweight construction and ease of stacking makes this antenna most popular of all UHF types. Conical or X elements provide a large signal "capture" area and broadband response to all channels.

3. **YAGI.** Usually made in three sizes to cover low, medium and high portions of the UHF band. Highly directional with narrow bandwidth to reject interference in poor locations. May be stacked for greater signal pick-up.

4. **CORNER REFLECTOR.** Highly directive. Covers all UHF Channels. Best for use in primary signal areas as its design does not always permit easy stacking.

5. **PARABOLIC REFLECTOR.** Uses either a single or stacked conical or X collector for broadband all-channel reception like the bow-tie. Bowl-shaped wire reflector provides remarkable directivity. Especially useful in high-noise areas for rejecting interference.

6. **ALL CHANNEL.** This radial stacked X antenna tunes in all directions without a motor drive. Comes with special 4-wire lead-in and selector switch. Maker claims good results on all UHF and VHF channels.

7. **STACKED HORIZONTAL V.** A directional variation of the "Lazy-H." Designed for primary service areas, two units may be stacked for greater range.

8. **RHOMBIC.** Designed to minimize ghost reflections. Covers all UHF channels. Like the yagi, stacked-V, stacked dipole and rod-type conicals, require more installation time than bow-ties.

Combined UHF-VHF Antennas. Where roof tests show a UHF works well in the same location as the present VHF antenna, you may be able to use a single lead-in for both antennas. Old lead-in wire must be replaced with low-loss oval or round lead-in, and the two antennas connected through a cross-over network filter, to the common lead-in. You can buy these filters from radio parts dealers, but results are not always as satisfactory as two separate antenna installations even if a common mast can be used for both.

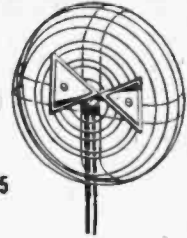

5

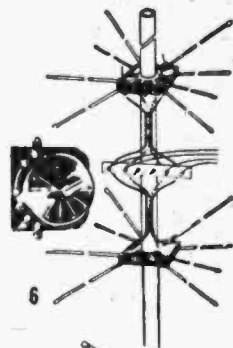

6

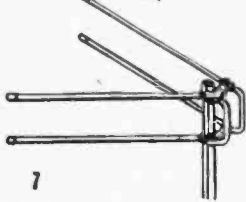

7



8

suggest channel 5 or 6 of your TV set; others use channel 10. If a VHF station in your area operates on channel 10, tune the set to the nearest unused channel. First choice, 9 or 11; second choice, 8 or 12.

In areas where stations are received on some of the 12 VHF channels, and especially on channels 5, 6 and 10, a converter may create interference on other nearby TV sets that are used for regular VHF reception. A converter using channel 10 as the I.F. is less apt to create interference.

A converter is attached to the TV set with a length of flat 300-ohm transmission line as short as possible from the terminals marked "Set" on converter to the "Antenna" terminals of the receiver. The UHF antenna is connected to the two converter terminals marked "UHF

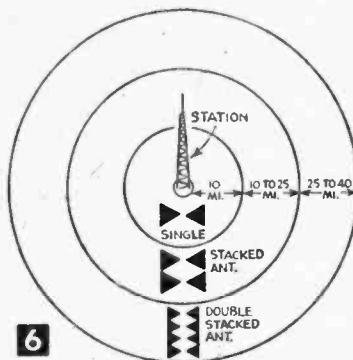

6

UHF antenna range chart for ordinary conditions.

Ant." or "Input."

The better UHF converters have two additional terminals marked "VHF Ant." Attach your existing VHF antenna to these terminals. UHF and VHF terminals are connected together by means of a short jumper when a combination VHF-UHF antenna is used. These better converters are fitted with a three-position switch which (1) turns on power to both converter and TV set, (2), couples UHF antenna to converter or (3) disconnects UHF antenna and

connects VHF antenna to the set.

For converters not equipped with the 3-way switch as well as sets equipped with a combination of VHF and UHF turret tuner strips, you can use either a D.P.D.T. midget knife switch (Fig. 5), or a special antenna change-

over switch. With converters, the short lead is connected to converter "Input" terminals, with another short lead from converter "Output" to TV set antenna terminals.

UHF ANTENNAS. There are more than 50 varieties of UHF antennas. Pictured in the accompanying sketches are some of the more popular types. All will provide good signal pick-up when used to maximum advantage in a given location.

The range chart (Fig. 6) indicates the popular "bow-tie" type UHF antenna effectively "captures" signals up to about 10 miles. Stacking two bowties may increase the range to 25 miles. A double stack (4 bays) may bring in UHF signals from up to 40 miles range.

However, the effective power of the TV station, sensitivity of your TV set, proper location of TV antenna and local geographic conditions prevent any hard and fast rule as regards reception beyond 15 miles from a UHF station. Before making a permanent antenna installation, connect a single bow-tie antenna to your TV set with a round or oval 300-ohm, low-loss type lead-in, and try several locations. With the antenna clamped to either a broomstick or clothesline prop, tune to the local UHF station, and draft an observer to watch the TV set. Move about on your roof trying different locations until you pick up the best signal. Moving the antenna just a few feet up, down or sideways from a given spot may make all the difference in the world.

After probing your rooftop for the best antenna location, mark the site with chalk. You

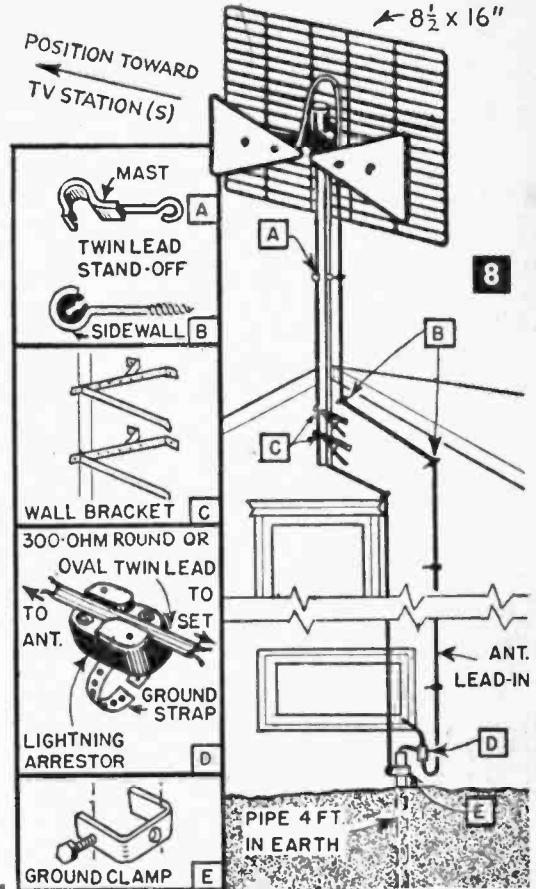

Installation of UHF antenna.

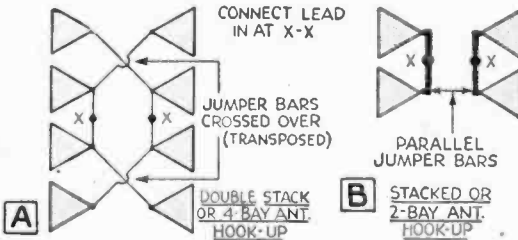

may now proceed to add an additional bow-tie for a 2-bay installation, or 3 more for a double-stacked installation if local conditions require. Most antenna manufacturers include a single jumper or tie rod with each antenna, so that, when stacked arrays are used, you don't have to buy extra antenna parts. Fig. 7A shows one way to connect stacked antennas. Make sure the jumpers do not contact one another at the cross-over point.

Some antenna makers pack specific suggestions for stacking their particular units in the antenna carton. A 2-bay installation as in Fig. 7B is not transposed. Lead-in wire is connected to terminals at center of jumpers. Solder the bare leads to the soldering lugs supplied with the antenna. Slip lugs on terminal screws and tighten rigidly. On stacked antennas, secure jumpers with nuts and bolts.

To protect terminal points from corrosion, apply a liberal coat of any of the several trichlorethylene sealing compounds available over nuts, bolts and junction points. Some antenna makers include a small tube of this sealer with each antenna. Larger tubes may be obtained from your radio parts dealer. Unless lead-in

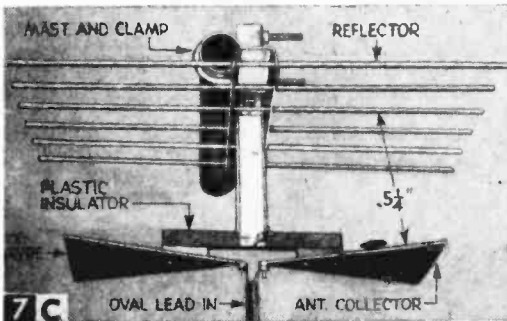

(A) Double-stacked or 4-bay UHF antenna hook-up. (B) Stacked or 2-bay antenna hook-up. (C) Top view of a single bow-tie TV antenna. Elements are made of aluminum or plated steel. Reflectors range from rod type, as shown, to perforated metal sheets according to manufacturer.

connections and jumpers are so coated, the UHF array may lose much of its efficiency after a few months of service due to salt air, smoke or even rain.

Erect the UHF antenna on as low a mast as possible consistent with good results (Fig. 8). While UHF antennas are smaller and lighter than VHF antennas, ice and wind can still play havoc with a high UHF mast unless well guyed. Radio parts houses can furnish telescopic masts in 5 and 10-ft. sections as well as roof, sidewall and chimney mounts. Avoid chimney mounts except when absolutely necessary, and then locate the mast on a corner that will keep the antenna out of direct hot flue gases. When possible, prevailing winds should be considered so smoke is blown away from antenna and not toward it.

Clip or clamp type stand-off insulators between 6 and 8 in. long are used to guide the oval or round 300-ohm lead-in down the mast (Fig. 8A), with screw type stand-offs (Fig. 8B) used on the house wall. Acute bends in the lead-in wire should be avoided, and the wire should, at all times, be kept as far away from electric, telephone or VHF wires, metal roofs, gutters and leaders as possible.

Because UHF lead-in of the round and oval types are hollow, you must prevent moisture from running into the tube. One method is to leave both ends of the lead-in open with the end connected to the antenna curved over the top of mast as in Fig. 9 to keep rain from running down inside the tubing. However, the open ends of the lead-in can be sealed. Once the lead-in length has been determined, place the coil of wire in a gas or electric range oven which has been preheated to 125° F. Allow the lead-in to remain in shut-off oven for about an hour to dry out any moisture; then seal both ends of the lead-in with a hot

Loop at top keeps water out of hollow oval-type 300-ohm lead-in at antenna.

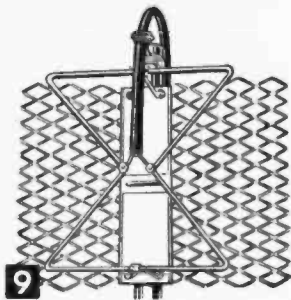

soldering iron (Fig. 10). The polyethylene insulation melts readily and an airtight seal is accomplished by the molten plastic.

In arid climates the pre-drying treatment is not necessary, nor in other localities during cold, dry weather when humidity is below 40%. Because oval and round twin lead-in lacks the flexibility of flat twin lead-in, terminate the UHF lead-in just inside the house and join it to the lighter, flat 300-ohm wire for convenient connection to set or converter. Indoors, low-loss lead-in is not needed since it is not exposed to the ele-

ments. In fact, ordinary flat lead-in may be used for the complete UHF antenna installation in arid areas since dampness caused by high humidity is seldom a problem.

With antenna installed and connected to set or converter, tune in the UHF channel. With a turret strip conversion, remove the channel selector plate on front of cabinet, turn the fine tuning control to its mid-point of rotation and make a minute adjustment of the oscillator slug screw visible through the hole in the upper right hand side of the tuner. Use an all-plastic screwdriver (including blade), turning the screw a "hair" left or right until picture and sound are best. Once adjusted, the turret conversion requires no further attention, tuning in UHF and VHF stations without critical adjustments.

Receiving the UHF station with the converter requires tuning the set to the specified I.F. channel (5, 6, 10), then slowly tuning the converter until a picture is received. Converter dials are not calibrated for each channel from 14 to 83, so you must "fish" for each station. Once tuned to maximum, some converters provide a brass detuning slug located on the back



Shank of a hot soldering iron drawn between wires of oval lead-in wire will melt and seal the air core against moisture (see text).

of the converter chassis (Fig. 4), for obtaining a proper match between converter output and TV set. This screw should be turned right or left for further signal improvement. Finally, the fine tuning control on the TV set should be rotated for any evidence of further improvement in picture quality.

It is obvious that tuning UHF with a converter is not as simple as with turret strips. Also, most converters remain On even when switched to VHF stations. While strips provide reception of only one UHF station, additional strips for new UHF stations may be added simply by pulling out another pair of unused VHF strips. Any set of UHF channel strips may be substituted for any VHF channel strips. Turret tuner sets can, therefore, handle six UHF and six VHF stations. Under the present FCC allocations, there can never be more than six VHF stations in a given service area, and it is not likely any given area will be granted over six UHF channels.—END

Want an Extra "Hand" for those long conversations?

Try this Telephone Amplifier



Anyone who has to write while listening to the telephone needs this amplifier, but it makes all long telephone talks easier.

THERE'S no longer any need for holding a telephone during long conversations, when the other party takes off to look up records or when you need both hands for writing while listening. With this amplifier, phoning becomes easy and pleasant. Here's how it works. To start the amplifier, just place the receiver into the pickup element and let it rest in the cradle (Figs. 1 and 2). An automatic switch operated from the weight of the telephone turns on the battery operated circuit. The other party's voice comes out the speaker at the right-hand side of the cabinet. To talk back, you simply speak into the cabinet opening around the transmitter. A volume control on the left-hand side allows you to adjust speaker volume, a big aid for persons slightly deaf.

The recess under transmitter works

To put hand set in position, slip receiver into pick-up unit and let handle rest on cradle. Plunger in the rest automatically switches on amplifier.

With a telephone on this amplifier, you not only hear what the person on the other end says, but can talk back by speaking directly into the front opening

By HAROLD P. STRAND

something like the head set in a bowl to amplify the sound so others could hear it as in the old days of crystal radios, except in this case, it works in reverse. Sound waves entering the cavity are reflected from its smooth surface into the transmitter and talking close and directly into the cavity in a normal voice, will give very comparable transmission to the other party. Sitting as far as 3 feet away and raising the voice a little, still permits conversation. From a distance of about six to eight feet you can still converse, but in a louder voice.

A small 2-stage amplifier builds up energy from the inductance pick-up coil to loud speaker volume. The

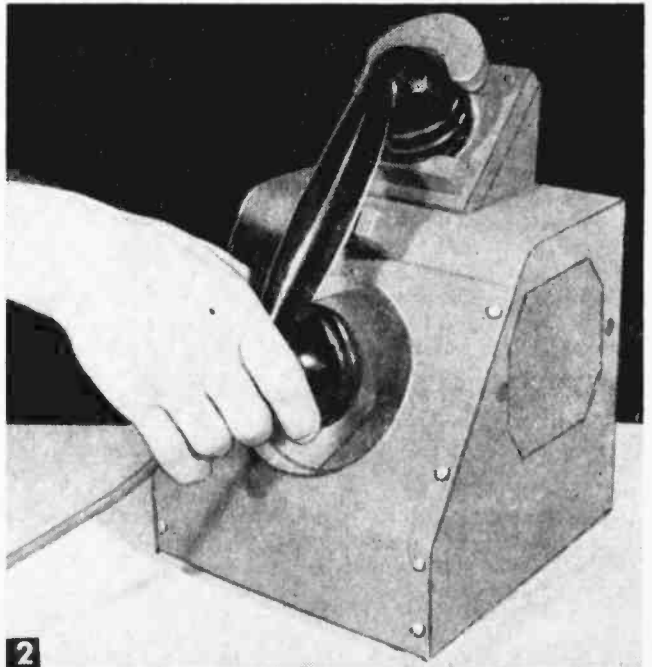

MATERIALS LIST—TELEPHONE AMPLIFIER (Electronic)

- 1 metal cabinet, sloping front, 8 x 8 x 8", Insuline Corp. 3990, gray ripple finish (radio supply house)
- 1 5" P.M. speaker, 1.47 oz. magnet or larger.
- 1 output transformer, 8000 ohms to 4 ohm voice coil. Stancor A 3229.
- 1 volume control knob with 0-10 attached dial. National type HRS.
- 1 telephone pick-up unit, Permoflux Corp., model M53-A.
- 1 terminal strip, 6 terminals, Jones 6-140.
- 2 miniature 7-pin sockets, Amphenol 147-500.
- 3 rubber grommets for 1/4" hole.
- 1 phono jack, RCA type. 1 phono plug, RCA type.
- 1 volume control, 1/2 meg., Mallory Midgetrol U-48. #1 taper.
- 2 chassis terminal strips, Jones lug type. 2 terminal.
- 1 1S5 miniature 7-pin tube. 1 3S4 miniature 7-pin tube.
- Resistors—1/2 watt carbon
 1 .47 meg. 1 1 meg. 1 2.2 meg. 1 680 ohm.
- Condensers—Aerovox disc type—
 2 .005 2 .01
- 2 snap terminals to fit 90 volt portable B battery.
- 1 terminal plug to fit 1 1/2 volt portable A battery
- 1 Burgess A battery 1 1/2 volt, type 4 F
- 1 Burgess B battery 90 volts, type N 60

- Misc. Materials
- 1 sheet aluminum about .050 x 3 3/4 x 9", chassis
- 1 sheet aluminum about .035 x 3 1/2 x 9", pick-up bracket
- 1 sheet aluminum about .025 x 6 1/2 x 6 1/2", cone
- 1 birch plywood, 3 3/8 x 4", pick-up base
- 1 birch or maple 1/2 x 3/4 x 3", receiver rest
- 1 birch or maple 5/8 x 1 1/2 x 2", cut out for hand set rest
- 1 birch or maple about 3/4 x 5 3/4 x 5 3/4", cone ring
- Sheet felt 1/8" thick as required to cover outside of cone
- 4 rubber knobs or feet with 10-32 machine screw studs, bottom of cabinet
- 1 3/16" Masonite hard board about 5 1/2 x 5 3/4", speaker baffle
- 1 grille cloth 5 1/2 x 5 3/4"
- 1 brass rod 1 3/4 long, 1/8" dia., switch plunger
- 1 brass tubing 1/8 I.D. 1/4 O.D. x 1 3/4", plunger bushing
- 4 phosphor bronze .014 x 3/16 x 3", switch springs
- 4 silver alloy contacts
- 1 Bakelite, canvas base, 1/8 x 7/16 x 1", switch spring spacer bar
- 1 Bakelite, paper base, 3/8 x 3/4 x 1 1/4", switch support block
- 2 pipe spacers, 1/8 I.D. x 1/4 O.D. x 7/16" long, switch spacers
- 1 perforated sheet steel, 2 1/4 x 7 3/4", cover for back opening
- Misc. screws, nuts, hook-up wire, paint etc.

Parts behind front panel. Note 1/8-in. felt backing on cone. Metal straps hold A and B batteries in place.

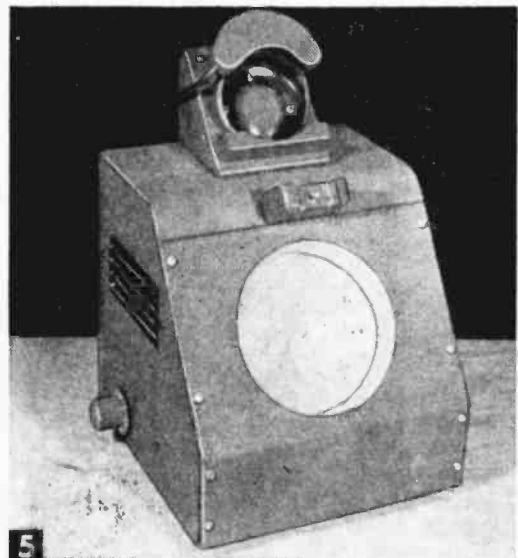
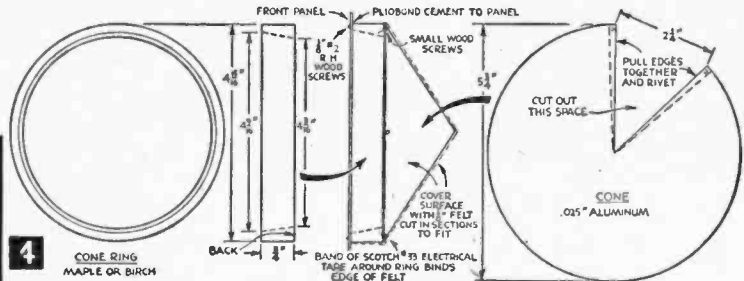
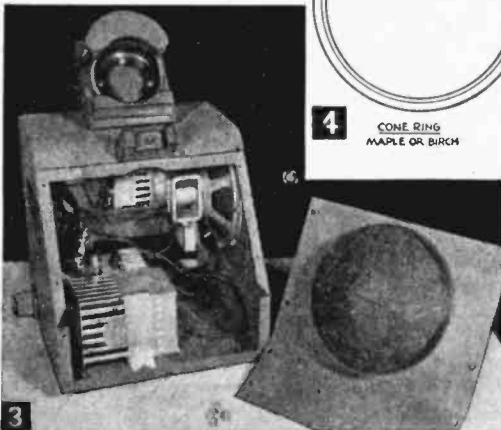

Cone under transmitter is open here, but may be covered with metal grill. Volume control is at left side and louvers help ventilate amplifier.

pick-up coil is made especially for picking up telephone conversation without any connections or alteration to the telephone system. It forms the most expensive component of the unit, selling for about \$10.00 at electronic supply stores, but since it is a key part, get a good one.

The unit is built around a gray-ripple finish stock cabinet, but an opening needs to be cut in front (Fig. 3). Cut the aluminum cone from .025-in. sheet stock (Fig. 4), and bend up to a cone with a rivet at the edge. Turn the wood ring from maple or other hardwood and mount between the cabinet panel and cone as shown in Fig. 4. The Permoflux pick-up unit must be trimmed around its front edge to allow the hand set to be slipped in and out easily (Fig. 6). Bend up the .035-in. sheet aluminum bracket that supports the birch plywood to which the pick-up unit is screwed (Fig. 6B). The Permoflux unit should be fitted to the receiver you plan to use it with. The receiver should be pressed into po-

sition and come to a stop against the hardwood block at the bottom. The hand set should slip in and out easily, yet be firmly held in position. Build up the leaf-spring switch that automatically switches on the set as shown in Fig. 6A. Silver alloy contacts were borrowed from the spring pack of an old telephone relay and

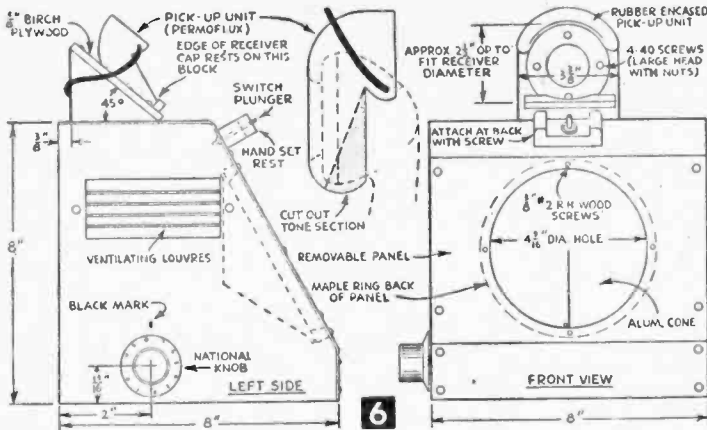

soldered to the ends of the springs. A piece of 1/8-in. Bakelite is riveted to the two top springs as a spacer bar. The brass switch plunger passes through a brass bushing in the maple block and rests against this insulated spacer.

The back surface of the aluminum cone is covered with 1/8-in. felt to deaden reflected sound and add to the acoustical value of the cone. The speaker can be seen mounted to its Masonite baffle, with the output transformer secured to the speaker frame. The amplifier has been placed to the left rear, where the volume control shaft can project through a hole in the side of the cabinet. The A battery is fixed in a front position with a strap and two bolts, and the B battery is secured to the upper right hand back section with a similar strap. Flexible #22 insulated wire is used for all connections, with standard attachment clips to the B battery and a plug to fit the portable A battery. These snaps make it easy to replace batteries as needed.

Bend up the chassis from the flat pattern shown in Fig. 8. Layout the holes and set the tube sockets for the two tubes.

Wire up the circuit according to the schematic diagram of Fig. 10. Mount the speaker behind the side hole in the cabinet and cover with grille cloth cemented over the opening. The volume control fits into a hole drilled in the left side (as shown in Figs. 5 and 6).

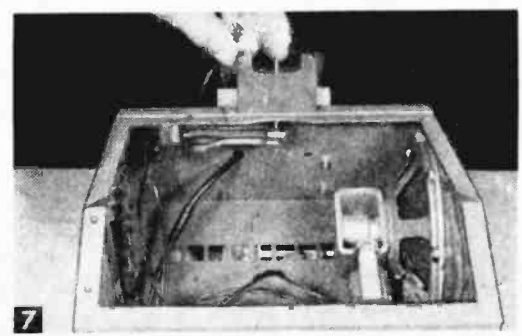
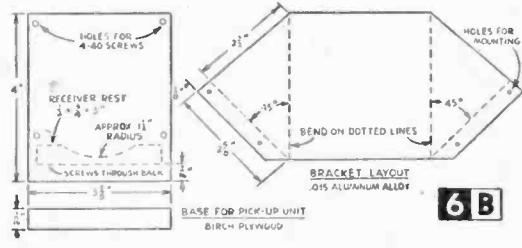
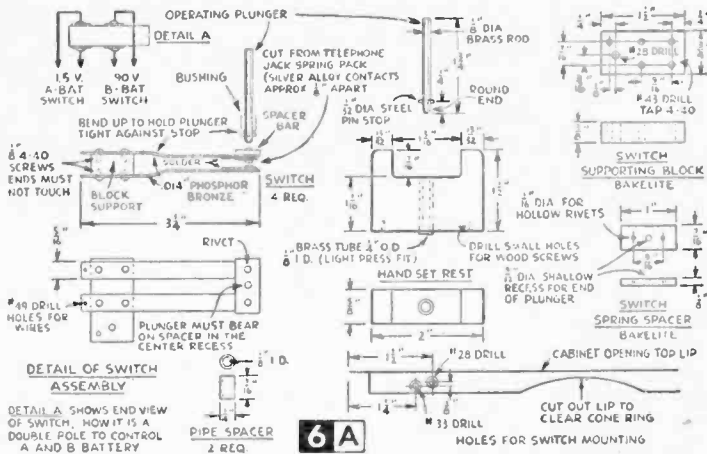

Switch plunger and leaf spring. Note how speaker is mounted to Masonite panel at right side. Heavy wire at left is shielded wire from Permoilux pick-up.

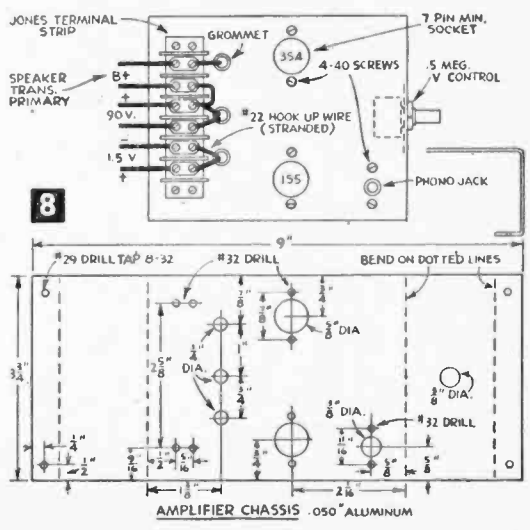

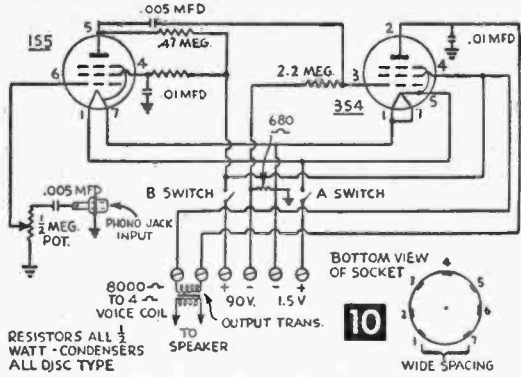
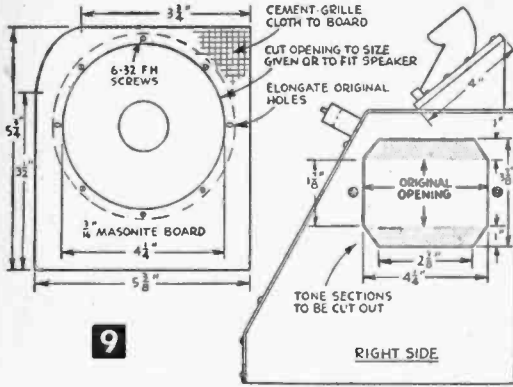

When using the amplifier, answer the telephone in the usual way to establish contact before placing the hand set in position. Then speak normally into the cone opening. The person's

voice from the phone will be amplified and come through the side speaker. Adjust the volume carefully, as the cone will pick up an annoying feedback squeal if the speaker volume is adjusted for too loud a volume.—END

Plug-in type radio coils are handled with a simple jig which makes a once difficult winding operation quick and easy.



Winding Small Coils

You can "roll your own" coil windings using simple shop tools and following these instructions

was $2\frac{9}{10}$ -in. on the original model, but the exact size of wire spool may vary among manufacturers. Check the brand of spool wire offered by your favorite radio parts supplier, and space the vertical supports accordingly.

To prevent the spooled magnet wire from getting out of hand while winding a coil, use a simple brake to maintain spool tension as the wire is being removed. This brake is merely a strip of spring brass with a fiber or smooth wooden strip cemented on the end with *Pliobond* or other all-purpose cement. The fiber piece acts as a brake shoe over the entire wire area (Fig. 3). After mounting the brake with two small screws, bend the brass strip inward to provide sufficient pressure against the spool of wire. An ordinary hand or breast drill gripped in the vise jaws drives the coil winder. Fit the drill chuck with one of several jigs which hold the coil form during the winding operation.

WHEN electronic, radio or TV projects call for home-wound coils, you're likely to find yourself in a jungle of snarled magnet wire unless you use some system. A simple coil-winding set-up (Fig. 1) allows you to wind practically any type of coil either on an insulated cylinder or a plug-in coil form. The winding apparatus consists of a vise, hand or breast drill and a home-made spool holder for unreeling the magnet wire as it is wound onto the coil form. The spool holder (Fig. 2) is made from $\frac{1}{2}$ -in. pine. Drill $\frac{1}{4}$ -in. holes for the spool supports and use a 20d (4 in.) building nail for the spool of magnet wire to rotate on. Spacing of supports

For winding coils on paper, plastic, or Bakelite tubing, two wooden cones lock the coil form on a threaded shaft made from a 6 or 8-in. eyebolt with 14-24 or $\frac{1}{4}$ -20 threads. The eye is sawed off, and the bolt inserted in the drill chuck. To mount a tubular coil form, run a nut up on the bolt, followed by one wooden cone. Slip the coil form over the bolt, and follow with the second cone. The coil form is secured by drawing up the wingnut. The wooden cones (Fig. 4) automatically center coil forms from $\frac{1}{2}$ to $1\frac{1}{8}$ in. diameter.

Fig. 5 shows how to make a handy jig for wind-

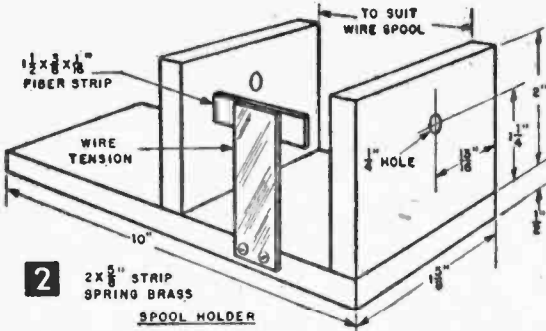

Spring brass leaf and fiber bar keep spooled magnet wire under tension, to simplify winding.

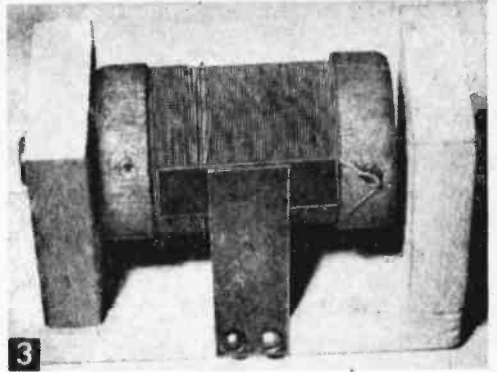

3

ing plug-in type coils. These coils, frequently used in shortwave receivers, are wound on 4, 5, or octal type bases salvaged from discarded tubes, or on plug-in type coil forms sold by many radio parts suppliers. Ordinarily, such coils are difficult to wind. Secure the jig shaft in the drill chuck and plug in the coil form, and winding the coil is quite simple.

Small plastic bobbins included with motor kits, or bobbins used for winding radio RF chokes, etc. may be wound by whittling a plug of soft wood to fit inside the rectangular or round bobbin. Drill a hole through the center of the plug and use a bolt, washers and nut to make the assembly rigid. The bolt is then inserted in the drill chuck and bobbin wound with the desired number of turns.

When winding single layer coils, drill a hole in the coil form to secure the end of the magnet wire. A thin coat of coil dope, sold by radio supply houses, may be applied to the form as the wire is being wound, to insure a coil with turns rigidly secured to the form.

Winding Coils from Hank Wire

Figs. 1 and 6 show how wire is guided onto coil form with the thumb and index fingers holding it taut. Wire, in various gages and insulations called for in radio projects, is sold only on spools. However, construction kits may include coil wire in hank form. Motors, electromagnets, etc. may be wound from the hank, by placing the hank over a milk or beverage bottle on the floor directly under your coil winding set-up.

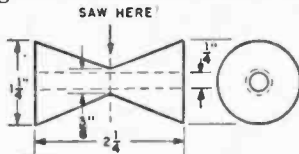

4 SELF-CENTERING WINDING CONES

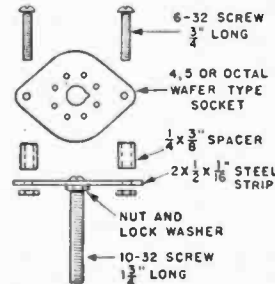

5 WINDING JIG FOR PLUG-IN COILS

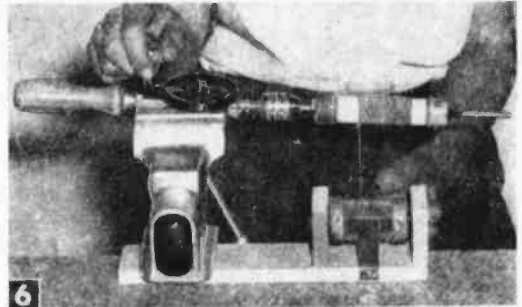

6

Winding coil on a tubular coil form.

The bottle will cause the wire to come off the hank in spiral fashion as you proceed to wind the electrical coil in question. Of course, the hank could be transferred to an empty wire spool but this additional operation isn't necessary if you exercise a little care.

While coil forms may be purchased in a variety of sizes, the experimenter will find many everyday household items that make ideal coil forms. Plastic pill vials, toothbrush containers, plastic sip straws, cardboard tubing from discarded flashlight cells, roll tissue or wax paper, cosmetic containers—all may be used as coil forms.—END

Pipe Cleaner File

• Save the instruction booklet which comes with your TV or radio set. It may be needed for tube replacement or operating instructions. A cardboard pipe cleaner holder pasted to the back or bottom of the receiver will accommodate such booklets. Do not cover ventilating holes in the radio or TV cabinet.—H. LEEPER.



Hi-Fi Boost for Your Table-Size Radio or TV

By ARTHUR TRAUFFER

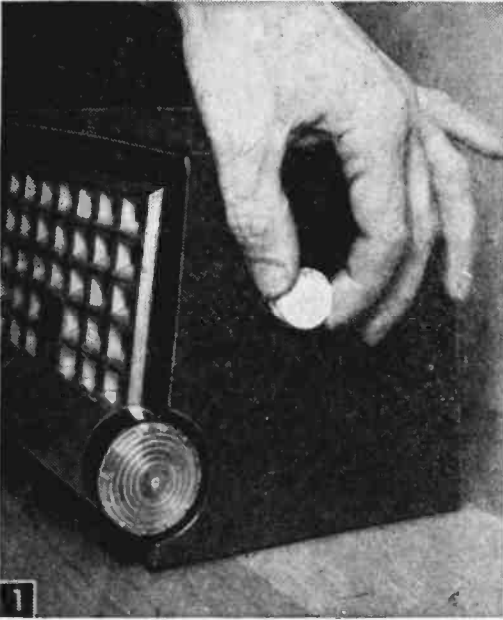

1 Band tracking capacitor for peaking response.

ALL the recent talk about high-fidelity may leave you more and more dissatisfied with the performance from your table radio. Most small sets with their 4- or 5-in. speakers cannot reproduce low-frequency notes effectively and their amplifiers cut off high frequencies, so the unbalanced sound actually does seem "flat." Low efficiency of the speaker's cone and magnet distorts tones even more when you call for loud volumes. Now, there's no use kidding—you can't make a high-fidelity set out of your 5-tube table-topper, but you can improve the sound and extend its frequency response range. The first step is to build a separate speaker enclosure and add a better speaker.

A good bass-reflex speaker baffle (Fig. 2) can cost little and supports your table radio or small TV set. This baffle adds low-frequency back radiation of the speaker in phase with the low-frequency front radiation, thus extending the speaker's response and sensitivity at low frequencies. One-half of the interior of the cabinet is covered with sound absorbing material to absorb the higher frequencies radiated from

the back of the cone into the cabinet (Fig. 3).

I picked a Jensen P8-RX Extended-Range unit (about \$8.25), as it has low distortion with very good high-frequency response, and it is capable of good bass response when properly baffled.

Table A shows volumes for bass-reflex enclosures according to speaker sizes. My 8-in. speaker required a cabinet volume of approximately 3,530 cu. in., and a port area of approximately 28 sq. in. (Fig. 4). For best results you must stay within 10% of these figures.

The cabinet (Figs. 2 and 3) should be solidly constructed from $\frac{5}{8}$ -in. or preferably $\frac{3}{4}$ -in. plywood. Securely join all panels, with the exception of the back panel, with glue and screws. Wood cleats across the front and rear panels help to reduce panel resonance. I even glued quarter-rounds inside the joints to keep them air-tight.

Two layers of $\frac{1}{2}$ -in.-thick hair-felt rug padding, jute padding, *Fiberglas*, or rock wool, should be tacked to the bottom, one side, and the back panel of the cabinet. Scraps of rug padding can often be obtained from furniture stores. Mount the speaker in the cabinet with four $\frac{1}{4}$ -20 *fh* bolts with lockwashers under the nuts. Wire screen, $\frac{1}{4}$ -in. grid, or hardware cloth between the speaker and the front panel protects the speaker cone. A few feet of POSJ (rubber-covered lamp cord) is soldered to the speaker voice-coil terminals and passed through a $\frac{1}{4}$ -in. hole drilled through the back panel and padding. The back panel should be screwfastened very tightly to the back of the cabinet. The entire cabinet, with the exception of the port, must be practically air-tight. You can finish the outside of the cabinet any way you like, but all sanding and finishing should be done before installing the speaker and the padding in the cabinet.

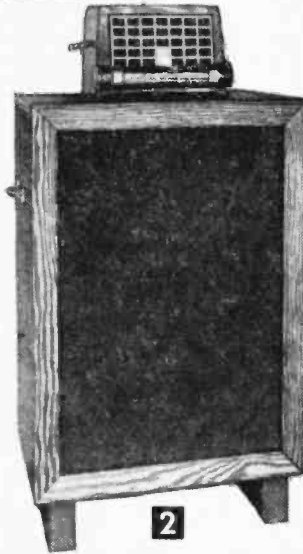

2 Bass-reflex cabinet mounting an 8-in. speaker is first big improvement for table radio.

TABLE A—PREFERRED VOLUMES FOR BASS REFLEX CABINETS
(Courtesy Jensen Manufacturing Co.)

| Speaker Diameter (Inches) | Inside Volume (cu in) | Port Area (sq in) |
|---------------------------|-----------------------|-------------------|
| 8 | 3,530 | 28 |
| 10 | 5,980 | 41 |
| 12 | 7,690 | 66 |
| 15 | 9,990 | 72 |

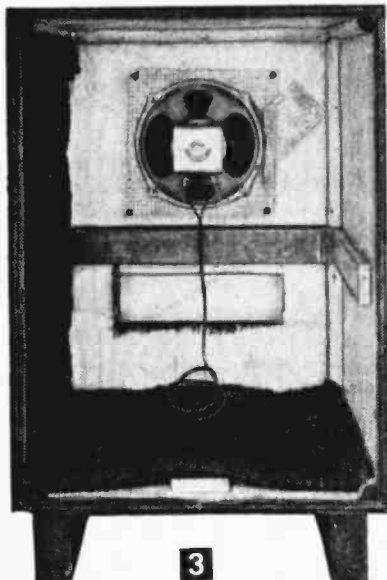

3

Inside of cabinet must be nearly air tight for top efficiency. Scrap rug padding lines one side, bottom and back to reduce high frequency reflections.

Rayon material, held in place by a hardwood frame, improves the cabinet's appearance (Fig. 2). Rayon is good because its loose weave and hard fibers do not absorb any of the sound waves, yet, you cannot see through it easily; color can be decorative, too!

Because the small speakers and baffles in table radios are unable to reproduce low-frequencies efficiently, manufacturers use low-capacity coupling-capacitors in the audio sections to cut production costs. Fig. 5 shows typical values found in many table radios. The audio coupling capacitors are marked "X" in the diagram; you will find one between the moving arm of the volume control and the grid of the first audio tube, and the other between the plate of the first audio tube, and the grid of the power output tube. When these capacitors are too small, they cut off the bass. With our speaker system, capable of much better bass response, we can replace these small capacitors with larger ones, in order to feed more bass to the new speaker system. In making this change we may increase the power-supply hum. If the hum is objectionable, or bad enough to impair fidelity, replace the filter capacitors in the power supply with new 60-mfd units.

Toggle switches (Figs. 5 and 6) allow you to cut by-pass capacitors in or out of circuit. Do not attempt to increase the bass response of the receiver by adding "tone controls" consisting of unreasonably large capacitors connected from the grids or plates of the audio tubes to ground. This practice doesn't actually extend the bass response at all, it only holds back the highs and makes the lows seem louder (the human ear

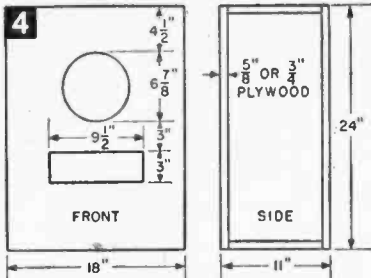

Size of cabinet and rectangular opening below speaker and location of speaker are important for building low-frequency response. Follow these sizes for 8-in. speaker.

is more sensitive to the low-frequencies when the high-frequencies are reduced in volume). What we are trying to do here is extend the response at both ends of the audio spectrum, not sacrifice one end for the other.

You can reduce the distortion and improve the frequency response of the power output stage of your table radio by simply adding negative-

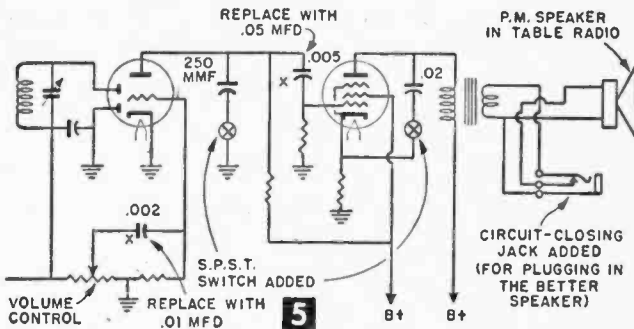

Audio circuit of a typical ac-dc AM table-top radio, showing simple changes and additions for extending frequency response and taking advantage of speaker opening two S.P.S.T. switches boosts "highs."

feedback, consisting of only one resistor connected from the plate of the first audio tube to the plate of the power output tube (Fig. 7A). This resistor feeds back part of the output signal voltage of T2 out of phase with the output signal voltage of T1. Thus, it cancels out much of the distortion present in the output stage. The amount of feedback depends on the size of the resistor; the smaller the resistor—the greater the feedback. With the average table radio a 1-watt 680,000-ohm resistor gives about 10% feedback. However, the use of resistors smaller than 470,000-ohms may result in too great a reduction in gain and high-frequency response. You'll need to experiment for best results. When this feedback resistor is added, be sure to disconnect the plate-to-cathode or plate-to-screen capacitor in the output stage in order to boost the highs (Fig. 7B). Gain can be increased by connecting a 25-volt electrolytic capacitor of 20 mfd, or larger size, across the cathode resistor of the power output tube, if there is not already a capacitor there (Fig. 7C).

Another spot for improving quality is to make sure antenna-capacitor and oscillator-capacitor track all the way across the standard broadcast band. Perfect tracking at all dial settings is absolutely necessary for maximum sensitivity, selectivity and fidelity. Figs. 1 and 8 show changes that greatly improved the performance of several ac-dc AM table radios. Simply connect

Switches cut out audio bypass capacitors to extend high-frequency end response.

a small variable capacitor in parallel with the antenna-capacitor to permit peaking the antenna-capacitor at any frequency in the band as follows: Remove the screw, washer and the small piece of mica on the trimmer-capacitor; then bend the little top plate straight up so it will have minimum capacity. Connect a small variable capacitor (about 50 mmf) as close to the antenna-capacitor as possible, and in parallel with it (Fig. 8). You can mount this capacitor on the side of the cabinet close to the capacitor gang (Fig. 1), or on the rear board of the cabinet, but keep the leads as short as possible. In use, simply rock the main tuning knob while you are adjusting trimmer-capacitor for volume.

To connect your new speaker system to your table radio, connect a phone plug to the leads from the new speaker, and connect a closed-circuit jack to the secondary of the output transformer (Fig. 5). Inserting the plug in the jack connects the new speaker and cuts out the small one in the radio. The jack can be mounted on the back panel of the radio. On table radios with one side of the output transformer secondary connected to the chassis; mount the jack somewhere inside the cabinet where it isn't easily touched.

The 8-in. extended-range speaker has a 6- to 8-ohm voice coil, while most table radios have a 3.4-ohm speaker and an output transformer to match. This mismatch is not important as the greater efficiency of the new 8-in. speaker more than compensates for it.

If you care to go to the expense, you can improve linear amplification over a somewhat wider frequency range by replacing the small output transformer in your table radio with one of higher quality. Your radio parts dealer can help you choose one that matches the 6- to 8-ohm speaker voice-coil to the output tube in your radio. For example, Stancor, types A-8050—A-8054 depending on output tube. Mount the new transformer on the speaker frame inside the bass-reflex cabinet, as you probably won't have room for it inside your table radio. The jack and plug are not used in this setup. Disconnect the two primary leads of the output transformer in your radio, and using a length of well-insulated lamp cord, connect the "plate" terminal on the primary of the new transformer to the plate of the output tube, and connect the "B plus" terminal on the primary of the new transformer to "B plus" in

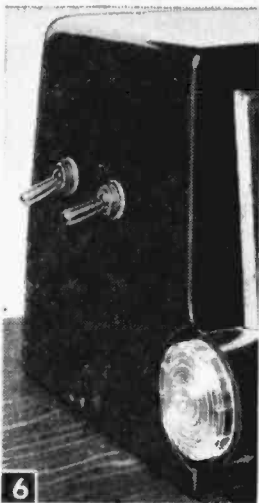

the radio, in the same manner as the old transformer was connected. The "common" and "6-ohm" or "8-ohm" terminals on the secondary of the new transformer connect to the voice-coil terminals on the new speaker. If you buy a hi-fi output transformer of the push-pull type, ignore the center-tap on the primary, and connect one "P" to plate of output tube and the other "P" to "B plus" in radio.

Some table radios do not use a by-pass capacitor across the cathode resistor (bias resistor) of the output tube. The absence of this capacitor

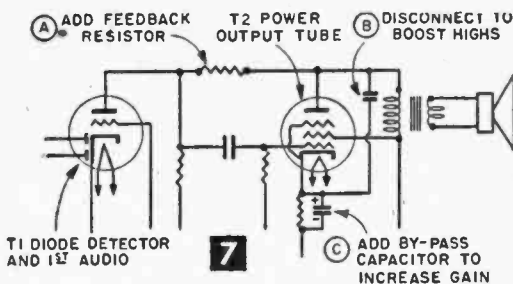

results in a certain amount of negative-feedback and reduces the distortion generated within the output tube. You might try removing this capacitor to reduce hum in the speaker and also to improve tone quality. Removing this capacitor may, however, reduce the output and low frequency response of the amplifier.

The simple audio circuit changes outlined here apply to all AM, AM-FM, straight FM table radios, and small table model TV sets, which use an audio circuit similar to Fig. 5.

If you are a real "bass bug" you can get more bass by using Jensen P10-RX or P12-RX instead

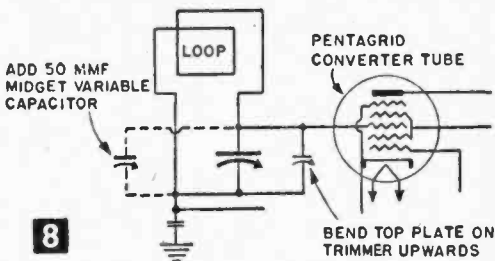

of the P8-RX 8-in. speaker. Consult Table A for cabinet sizes for the larger speakers.

You will also find that the speaker-and-baffle combination described in this article is very satisfactory for use with hi-fi phono amplifiers, PA systems, tape recorders and home movie sound projectors.

Remote Speaker for Your Car Radio



1

Add to your outdoor fun with an extension speaker that brings your car's radio right to the beach or woody picnic.

MUSIC, news and sportscasts wherever you go—to the beach, on picnics, camping trips and at vacation stop-overs in motels—all by simply installing an extension speaker that operates from your car radio. Parts cost but a few dollars—usually no more than you would pay for a new set of portable radio batteries. Connections for the “away from it all” speaker don’t involve the radio, just the two leads to your car’s present speaker.

The simplest hook-up (Fig. 4) allows both the car speaker and the extension speaker to play together. A slightly more involved hook-up (Fig. 5) automatically disconnects the car’s speaker when you plug into the extension speaker jack.

While two speakers operating together do not draw any more current from your car’s battery than a single speaker, you must watch your time and not play the radio so long that the battery won’t start the car. How long that will be will depend on the battery capacity, its age and initial charge. Usually you should not play a car radio more than three or four hours between times you run the engine if the battery is fully charged at the beginning.

The extension speaker cabinet (Fig. 2) is an inexpensive wooden intercom type measuring 6 by 7¼ in. but a cigar box would serve as well. Attach a chrome drawer pull to the top for a carrying handle. Mount a 5-in. PM speaker in the cabinet and solder a suitable length of flexible, plastic coated fixture cord to the speaker terminal lugs.



2 Intercom or dressed-up cigar box houses 4 or 5-in. speaker. Extension cord is ordinary fixture wire.

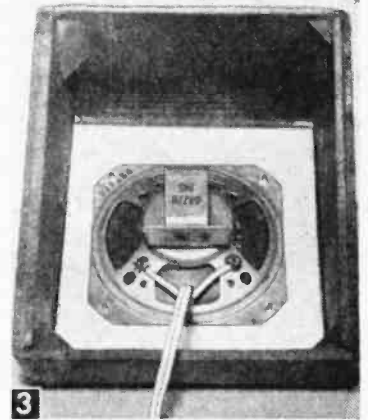

3 Only two connections, soldered to speaker lugs are necessary. There’s ample space in the back of the cabinet for storing up to 50 ft. of cord.

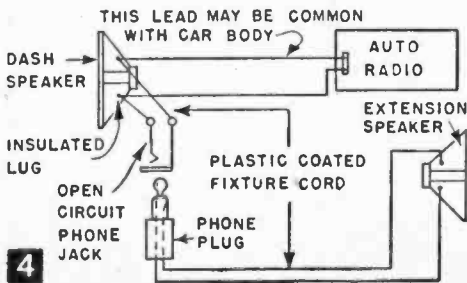

4

Simple 2-wire connections leave regular car's speaker hooked up when extension speaker is plugged in.

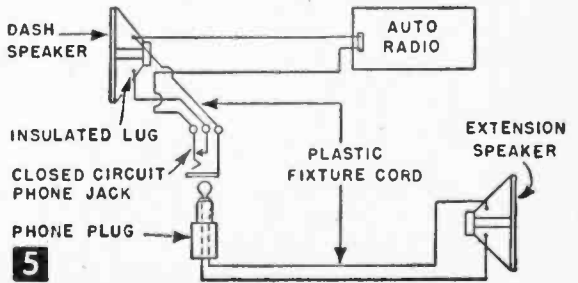

5

Closed circuit phone jack automatically cuts out car's speaker when extension speaker is plugged in.

Connect the remaining ends of the extension cord to a plain 2-conductor type phone plug by unscrewing the plastic cap and soldering or screwing down the leads on terminals provided inside the plastic shell. A small latch attached to a lid over the back of speaker cabinet permits extension cord storage inside for carrying.

MATERIALS LIST— REMOTE SPEAKER

- 1 wood or metal intercom speaker cabinet (or homemade box to fit a 4 or 5-in. PM speaker)
- 1 PM speaker; any convenient size depending upon cabinet
- 1 length of plastic "zip" type fixture cord
- 1 2-wire phone plug (ICA, Mallory, Kellogg)
- 1 open or closed circuit phone Jack (Mallory, Littell, Kellogg)
- 1 auto heater rheostat clamp type bracket
- 1 chrome or plastic drawer pull for handle on cabinet of remote speaker

Sometimes only one wire runs from the speaker to the car set, as one side of the radio output transformer secondary and one side of the speaker frame is grounded to complete the circuit. Following the hook-up in Fig. 5, disconnect the wire from the speaker's insulated lug, attach a piece of wire long enough to reach to the phone jack, and tape up the connection. Run an equal length of wire from the now vacant insulated speaker lug to the center switch contact lug of the jack. Finally run a third wire from the remaining speaker lug (be it grounded, insulated, or merely bare metal frame) to right-hand lug of phone jack.

In the simpler hook-up shown in Fig. 4, it is only necessary to attach a length of 2-wire cord to the car speaker lugs, not disturbing any wires already connected, and terminating them on the two jack lugs.

The jack mounts in a $\frac{3}{8}$ -in. hole which may be drilled in the dash at any convenient point. However, if you would rather not drill the dash, a metal clamp-on heater rheostat bracket may be obtained at an auto supply store to mount the jack. Use $\frac{7}{8}$ -in. O.D. x $\frac{3}{8}$ -in. I.D. washers behind the large rheostat opening. Complete the assembly by drawing up the $\frac{3}{8}$ -in. jack nut. When one side of the car speaker is grounded to the body, only one wire must be used in Fig. 4 hook-up. Make sure jack is in good contact with metal at mounting point. For Fig. 5 hook-up, only two wires are necessary. Right-hand jack connection in each drawing may be disregarded, therefore.—END

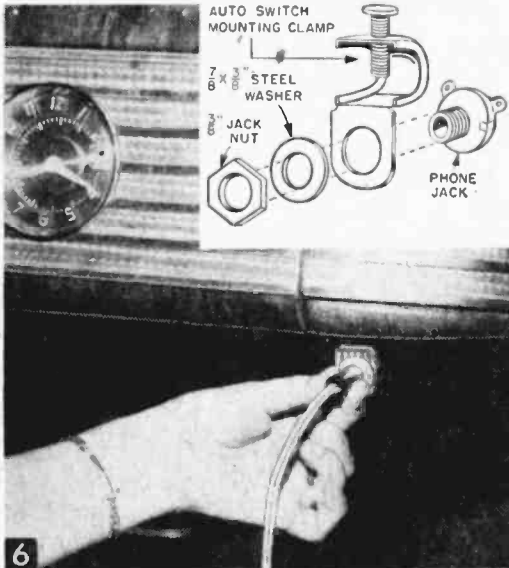

Auto heater rheostat mounting clamp permits you to mount phone jack without drilling through dashboard.

How you make the connections to the car radio's speaker will depend on the type of radio. Locate the car radio speaker by looking up under the dash. In many sets installed in the car at the factory, the speaker is connected with the same "zip" fixture wire used on your extension cord. The cord may go directly from speaker into metal radio cabinet, or there may be a plug on the cabinet for disconnecting the speaker. Sometimes it is more convenient to pull the speaker out from the dash and make the connections shown in either Figs. 4 or 5 in your shop. If your car radio includes the speaker integral with the chassis, you may have to drop the chassis to make the speaker connections.

Handy Counter from Radio Dial

- When keeping count of various products, jobs or parts you won't have to use paper and pencil, or rely too much on the memory, if you make this handy counter from a radio tuning dial salvaged from an old battery radio or from the junk

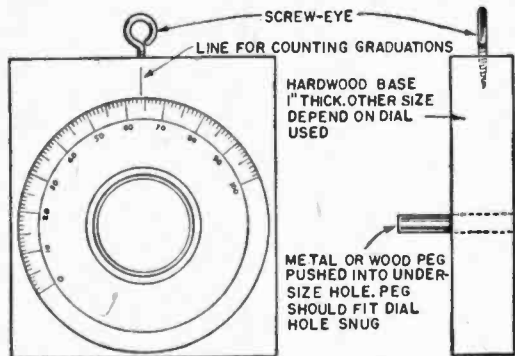

yard. Mount the dial on a 1 in. thick hardwood base with a hardwood peg friction tight in the dial hole. The length and diameter of the peg depends on the hole in the dial. A screw-eye allows the counter to be hung on the wall.—ARTHUR TRAUFFER.

UKE-ATRON

Electronic musical effects ranging from fife to tuba can be created with the one-tube all electric

UNUSUAL electronic music and sound effects such as synthetic electronic speech can be created by the skillful manipulation of the playing lever of this simple all-electric, 1-tube feedback audio tone oscillator. By moving the playing lever slowly from one end of the scale to the other, the effect is as realistic as a screaming fire siren.

Because the musical scales are created by a continually variable (and not tapped) grid resistance, trombone effects such as "riding" the scale are possible. When the range switch is set to simulate some other instrument, it too can achieve effects ordinarily only possible with a trombone, slide whistle, and steel guitar.

The oscillator itself is a neat, compact unit constructed in a standard size aluminum radio chassis box (Fig. 2 and 5). However, the pictorial wiring plan (Fig. 3) has been arranged so that the size or shape of the box is not an important factor. The transformer shown (Fig. 2) is a hermetic-sealed military type which normally sells for about \$8. However, the Stancor #A-53 open frame transformer (shown in Fig. 3) costs only \$1.60 at all radio parts houses and is equal in performance to the sealed unit for this application. If you are fortunate enough to find the sealed type in a surplus store, you will note that the windings terminate on lugs, rather than color-coded flexible leads.

Cut a 1½-in. hole in the top of the chassis box for mounting the tube socket. Drill a similar hole for the sealed-type transformer, or drill two ⅜-in. holes for passing the leads of the open frame transformer to the underside of the chassis. Drill another ⅜-in. hole on the rear apron of the box for passing the line cord. The 4-position tap switch requires a ⅜-in. mounting hole, while the cable-connecting socket requires a ⅝-in. hole.

Now install all stationary components. The octal tube socket may be either the wafer or retainer ring type. The miniature cable socket



1 The Uke-Atron, an electronic playing device, is held guitar fashion. PM speaker, mounted in standard wooden cabinet, and oscillator unit appear in foreground of photo.

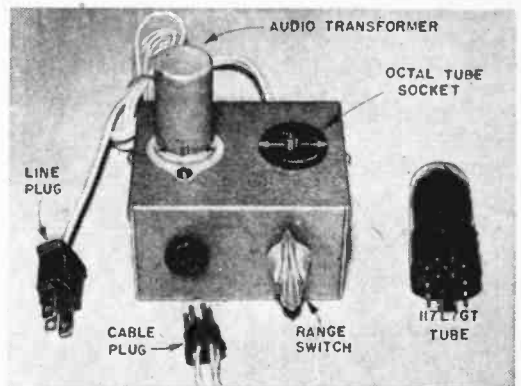

2 Audio transformer used in original model is a hermetic-sealed can type. Plans show inexpensive open frame type.

mounts with a retainer ring furnished by the manufacturer. Note that only four pins have connections, with pin #3 left blank.

The tap switch is a Mallory #3215J non-short-ing type, with five positions. The fifth position may be left blank or, for even lower musical

tones (as in a tuba), a .003 mfd capacitor may be added. The capacitors shown in the picture plan include a ceramic 250 mmf for fife, 500 mmf for clarinet, .001 mfd for trumpet, and .002 mfd for trombone effects.

The oscillator is a complete unit and the circuit's simplicity is enhanced by the plug connector to the PM reproducer and playing device. The tube is a dual-purpose type, operating directly off the power line without resorting to either transformer or voltage-drop resistor.

Half of the 117L7/M7GT tube is a pentode wired to function as a triode oscillator. The remaining tube elements provide a half-wave rectifier for changing the line voltage from a-c to d-c.

Now let's work on the playing device (Figs. 6 and 7). At one end of the hardwood stick, mount a doorbell pushbutton of the elongated type. Dime stores have switches of this design, but with a "floating" button, which does not give very positive closure. However, electrical supply houses, hardware dealers and independent variety stores can supply the Edwards Keynote

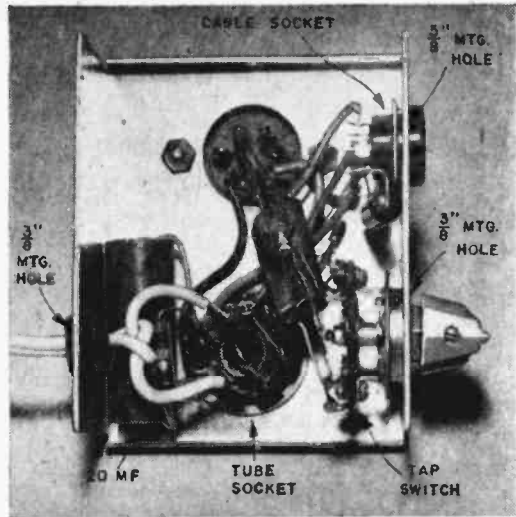

5 Oscillator chassis with cover removed. All wiring is enclosed to eliminate possibility of damage or shock.

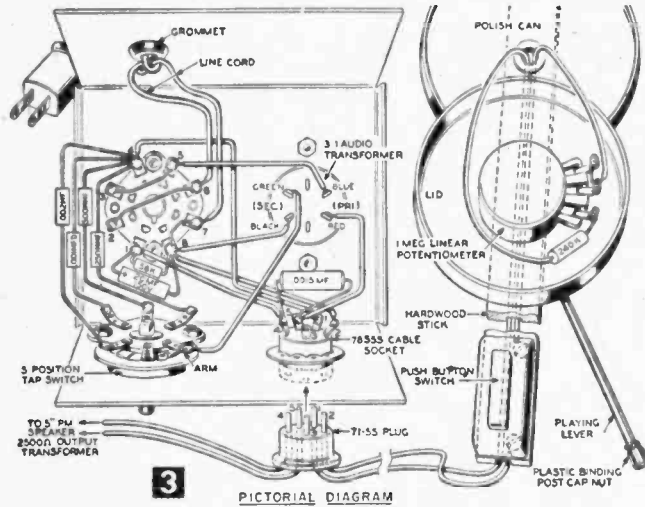

PICTORIAL DIAGRAM

pushbutton, which has a lever action for rapid control of musical notes.

At the middle of the stick, mount the playing device, which is merely a 1 megohm potentiometer connected in series with a 240,000 ohm (240K) fixed resistor and mounted in the lid of a friction-type cannister, such as a shoe polish box. Screw the base of the polish can down to the stick, and drill a 1/4-in. hole through the hardwood handle for running the leads to pushbutton and on to the cable plug.

Cut a slot in the back of the handle so the leads will fit flush in the groove. A 10-in. strip of plastic tape running up the handle will keep the wires in place. Connect these wires to pins #1 and #2 of cable plug.

It is of the utmost importance that the potentiometer be a linear type. Mallory identifies such controls as Taper #4. IRC controls are identified as Taper A. For this instrument we suggest that IRC #11-137 Industrial PQ potentiometer be used. These controls are provided with a shaft longer than necessary. Cut off the excess with a hacksaw.

Attach a 2-in. Daka-ware bar pointer knob to the potentiometer shaft. However, to provide tuning leverage, remove the set-screw in the knob and replace with a 3 1/2-in. screw or rod threaded 8-32. This serves both as screw to secure knob to shaft, and as tuning lever. A 8-32 threaded plastic cap nut such as is

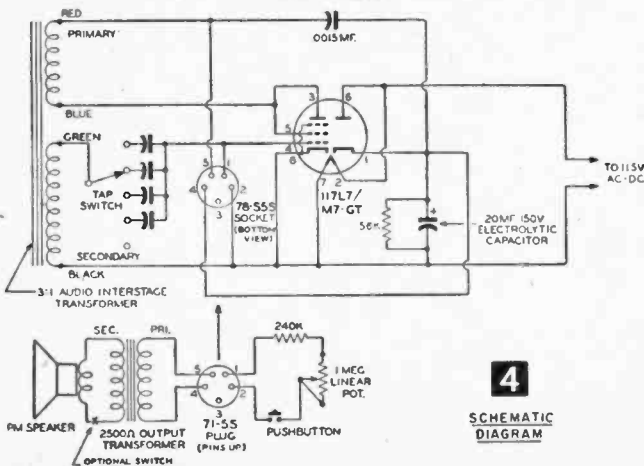

SCHEMATIC DIAGRAM

provided with radio terminal posts, is screwed on the end of the lever to serve as a knob.

The final detail is to mount a 2500-ohm audio output transformer to the frame of the 5-in. PM speaker, for which mounting tabs are provided. Solder the plain enameled transformer secondary leads to the voice coil lugs on the speaker after scraping off the enamel on the wire leads. Finally, attach the primary side of the output transformer by means of a suitable 2-wire cable to pins #4 and #5 of the cable plug.

Install the assembled speaker in an inexpensive wall-type baffle box, such as is sold by all part suppliers. However, a homemade speaker cabinet can be used if desired.

Learning to Play

To test the performance of the instrument, insert the cable plug into the miniature socket, connect line cord in outlet, and allow about 30 seconds for the tube to warm up.

Holding the instrument much like a guitar, move the playing lever, then depress the button. Holding the button down and swinging the lever back and forth, the siren effect previously described will blare forth from the speaker. If no sound results, check wiring and test tube. If these points prove okay, merely reverse primary connections of audio interstage transformer.

Anyone who can play a harmonica can easily master this novel electronic instrument. As a playing aid, paste a paper disc under the pointer knob. Swing lever to find middle C, then mark off the octave above and below the keynote. Don't forget to include sharps. Each position of the tap switch covers two full octaves, with a total range for the gadget of ten octaves.

To grasp the operation of this instrument more easily, consider it in the same light as any wind instrument. The lever is the *valve*, and the push-button, *breath*. Swing the lever to the desired note, then push the button. Any note can be sustained indefinitely. Because of the piano key action of the Edwards pushbutton, many novel effects in tempo are achieved by skillful fingering.

How to Eliminate "Plop"

Note that when the instrument is not being played, there will be heard a periodic dull "plop" from the speaker. Because of the nature of the oscillator, the grid is left partially *floating* except when being played. If for any reason the plop is objectionable to you, here's what you can do.

Remove the pushbutton from its position in series with the potentiometer, and make the circuit continuous between potentiometer, 240K resistor and plug pins #1 and #2. Disconnect

MATERIALS LIST—UKE-ATRON

- 1 aluminum utility or chassis box; 3½ x 3 x 2 (LMB CO., 1011-SM Venice Blvd., L. A. 15, Calif.)
 - 1 3:1 ratio audio transformer; sealed type or Stancor #A-53 open frame 3:1/1:3 ratio.
 - 1 octal molded or wafer socket (Amphenol, Cinch, etc.)
 - 1 5-pin miniature socket (Amphenol #78-55S)
 - 1 5-pin miniature plug (Amphenol #71-5S)
 - 1 5-in. PM speaker with 2500 ohm output transformer (transformer sometimes called 50L6 type)
 - 1 117L7/M7GT radio tube
 - 1 6-ft. line cord and plug
 - 1 Mallory #3215J non-shorting rotary switch
 - 1 20 mfd 150 v.v. electrolytic tubular capacitor
 - 1 .002 mfd 400 v. molded paper capacitor
 - 1 .001 mfd 400 v. molded paper capacitor
 - 1 .0015 mfd 400 v. molded paper capacitor
 - 1 500 mmf mica or ceramic capacitor
 - 1 250 mmf mica or ceramic capacitor
 - 1 IRC Industrial Type PQ potentiometer #11-137. Range: 1 megohm with A Taper
 - 1 56K composition fixed resistor, 1 watt (56,000 ohms)
 - 1 240K composition fixed resistor, ½ watt (240,000 ohms)
- rubber hole grommets, 2-in. bar knob, hook-up wire, screws, nuts as needed, ¼ x 2¾" dia. shoe polish can, 20 x 7/8 x 1/2" hardwood stick, and doorbell push-button (Keynote Chime button made by Edwards & Co., Dept. A, Boston Post Rd., Norwalk, Conn.)

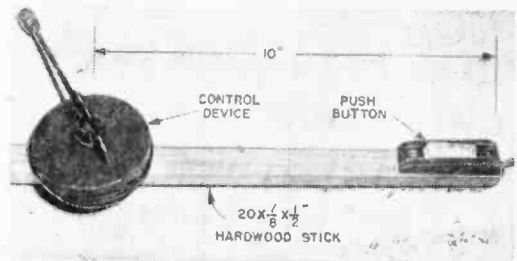

6 Playing device consists of hardwood stick to which is mounted push-button and control device.

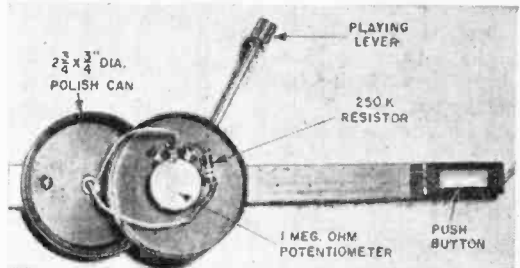

7 Inside of can which provides enclosed mounting for the potentiometer and 240k fixed resistor.

one wire from speaker output transformer that connects to voice coil lug on speaker frame. Connect pushbutton at this point (X in schematic) with a suitable length of 2-wire cable to reach from speaker to pushbutton on handle.

This arrangement requires a 4-wire line from instrument to oscillator, and has not been illustrated in the original design.—END

Giant Loop Crystal Set



By ARTHUR
TRAUFFER

IN BOTH performance and appearance this enlarged loop crystal set is a considerable improvement over many of the existing loop crystal sets. Wound around a 14 x 24-in. wood frame, the large loop results in greater signal pickup and increased range. A further improvement is the tap on the loop, which improves selectivity and helps to separate stations in crowded broadcast areas. This portable set requires no antenna or ground when used in strong signal areas. For greatest signal pickup, the loop should be directed toward the desired station.

Use $\frac{3}{8}$ x 3-in. white pine for the 14 by 24-in. loop frame. Glue the joints, using wire brads or short finishing nails if needed. Brace the top

corners of the frame by gluing 3-in. lengths of quarter-round into the corners. Jigsaw the combination feet and corner braces from wood a full inch thick, and glue into the bottom corners of the frame. Jigsaw the handle from $\frac{3}{4}$ -in. wood.

Sand the frame, feet and the handle, rounding off the sharp corners and edges. Then give two coats of white shellac, sanding lightly after each coat of white shellac.

Make a template of the variable capacitor and drill the mounting holes in the top center of the loop frame. Then mount the capacitor with three short *fh* machine screws. Let the tops of the screws sink flush with the wood, but don't allow the ends of the screws to touch and bend the capacitor plates. Use a small ivory plastic pointer-knob with a set-screw for the capacitor shaft. The lug on the bottom of the capacitor frame goes to the stationary plates, while the frame connects with the rotor plates.

For the loop shown, 11 turns of $50\frac{1}{4}$ single-Nylon-coat Litz wire, were used but you can get as good results with 20- or 22-gage Belden Cot-

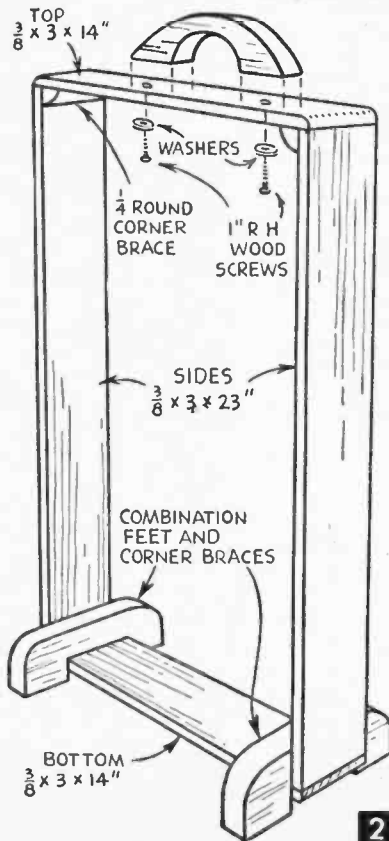

MATERIALS LIST— ENLARGED LOOP CRYSTAL SET

- 381.4 mmf variable capacitor
- 1 pr. earphones, at least 2000 ohm impedance
- Small ivory pointer-knob with set-screw
- 85 ft 20 or 22-gage Belden Cotenamel
- Germanium diode (Sylvania 1N34)
- 2 phone-tip jacks
- 1 soldering lug
- 2 rh wood screws 1" long, and 2 washers to fit
- 1 rh wood screw $\frac{1}{4}$ " long (soldering lug)
- 3 short *fh* machine screws to fit variable capacitor
- 7 ft length $\frac{3}{8}$ x 3" wood
- $\frac{3}{4}$ x $2\frac{1}{2}$ x 7" wood (handle)
- 15" x 2" x full 1" wood (combination feet and corner braces)
- 7" length quarter-round
- shellac and clear varnish

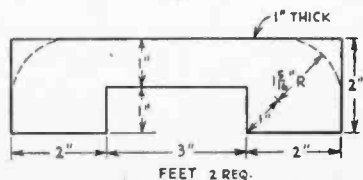
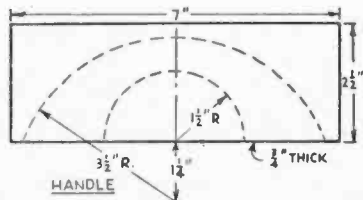

FEET 2 REQ.

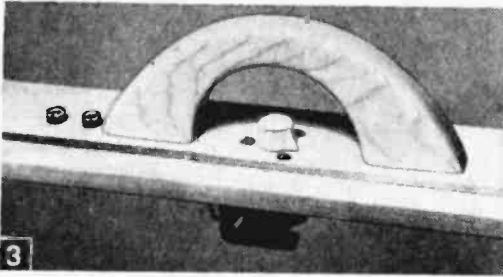

enamel, or any similar gage insulated solid copper wire. Don't use anything smaller than 28-gage though, and the larger the better. Remove all insulation from one tip of the wire, including the enamel coating. To get the bright copper color use steel wool or scrape lightly with a knife.

Bore a small hole (a small wire nail with the head clipped off makes a good drill for soft wood) through the top of the frame close to the frame of the variable capacitor, bring the cleaned end of the wire through the hole, and solder it to the frame of the capacitor. Now wind four turns around the frame, snip off the wire and bring the end through another small hole and solder it to a lug fastened underneath the frame top. Pass another wire end through the same hole and solder it to the same lug, and continue winding in the same direction until you have a total of 11 turns around the wood frame. Drill another small hole, and bring the end of the wire through and solder it to the stator lug on the variable capacitor. When winding the coil, space the turns slightly, not more than $\frac{1}{16}$ in. For a more balanced appearance, wind the turns the full width of the loop, allowing about $\frac{1}{8}$ -in. space between the turns. This wide spacing between the turns will reduce the overall distributed capacity of the loop winding, making it necessary to add an extra turn or two to the loop. Experiment for best results. Leave adequate space for the handle.

The tap at the fourth turn will give good selectivity without the loss in sensitivity resulting when the tap is on the third turn. After completing the winding, give the entire frame and winding a coat of clear varnish and let it dry thoroughly. Pre-bore the handle to prevent splitting. Fasten the handle onto the top center of frame with two 1-in. rh wood screws and washers.

When mounting the two tip-jacks onto the top of the frame, bore two holes through the frame, using a drill slightly smaller in diameter than the threaded shanks of the tip-jacks, and twist the jacks into the holes. Connect the tip-jack farthest away from the variable capacitor to the frame of the capacitor. A 1N34 germanium diode connected from the remaining tip-jack to the loop tap lug, completes the simple wiring. It makes little difference whether the cathode of the germanium diode goes to the jack or goes to the loop tap lug.

If you want to get fancy, mount a single-pole

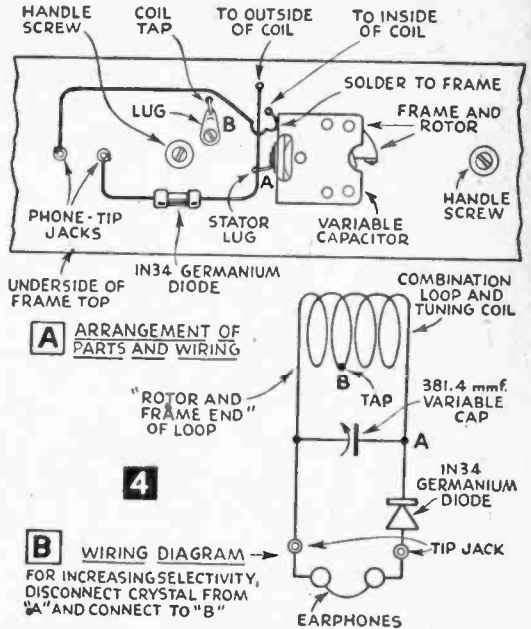

double-throw toggle-switch onto the frame top, and connect it so you can throw the crystal from point A to point B at will. Another way is to mount a third tip-jack in line with the first two, and connect an extra 1N34 diode from the third jack to point B. Then you can change from broad to sharp tuning simply by plugging one phone tip into either of the two crystal jacks.

For greater sensitivity (but sacrificed selectivity) connect an antenna to the stator lug on the variable capacitor. Placing the loop close to a floor lamp or table lamp increases the sensitivity due to the pickup from the power lines, but selectivity and loop-directivity is reduced somewhat. Standing the loop close to a wall containing open (unshielded) power lines, also increases the volume somewhat.—END

Movie Reels Store Wire or Cord

Electricians and radio service men can use several space-saving 16 mm motion picture projector reels to store various colors and sizes of

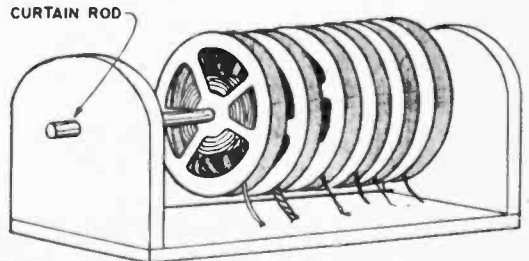

wires, string or cord. A $\frac{5}{16}$ in. dia. curtain rod through wood end brackets holds the reels and permits them to revolve freely.—M. A. JACKSON.

Line Voltage Corrector for Your TV Receiver

By HAROLD P. STRAND

LOW line voltage from your electric company can cause all sorts of difficulty in your TV set. Since electric companies can't supply everybody with exactly the same voltage, outlying suburbs are most likely to be troubled with below-normal voltage, particularly during the evening hours when demand for electricity is high. If you're not satisfied with your TV picture, it doesn't fill out the screen or lacks brilliance, try connecting an a-c voltmeter to the wall receptacle to determine the line voltage. If I had done that myself, I would have saved considerable time and money.

The picture on my set was not filling the screen, especially at the sides and was not up to its usual brilliance despite any adjustments of the brightness control. The picture kept slip-



Picture wouldn't fill out screen when set was operating on 106 volts (A). Increased brilliance and full screen (B) improve picture after boosting line voltage to 112-115 volts.

ping out of horizontal sync too. Something had to be done!

First, I replaced all the tubes in the video section, with very little improvement. Next, I removed the chassis and spent two evenings going over the complex circuit using instruments to check the connections and the components against the schematic. Still no luck! Some of the original condensers were bulging with sealing compound at the ends, so all of them were replaced with the latest type. You can imagine my

Checking line voltage on meter built into booster. Voltage that's too low causes all sorts of trouble on your TV set.



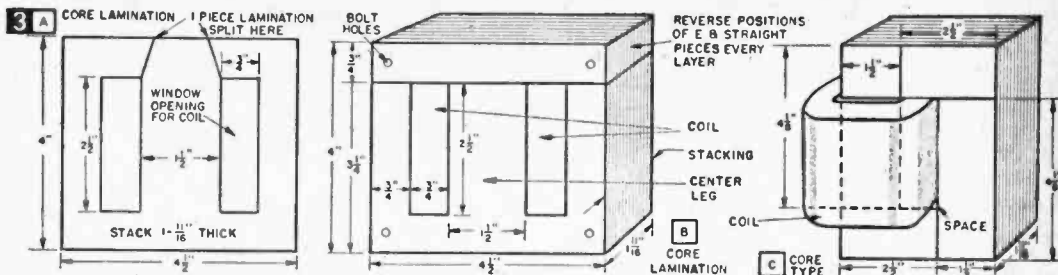

Core laminations (A) 1-piece shell lamination salvaged from used radio power transformer. (B) E-type laminations (C) Core-type lamination made by alternating straight strips of silicon transformer steel. Transformers built on this core will require larger mounting box. (D) Coil winding form.

disappointment, when after assembling the set, the improvement was hard to find.

On an impulse, I got my voltmeter from the shop and plugged it into the outlet. I was getting exactly 106 volts! When I connected a Variac between the line outlet and the TV set and raised the voltage to 115 volts, the results were amazing. The picture assumed a brilliance it had never had before and it covered the screen with some to spare! You may find the same solution to your television difficulties.

Instead of using the Variac, this line voltage booster which you can build yourself will step up line voltage and give you all the reception which your TV set can deliver. Basically it is an auto-transformer with a number of taps controlled by a tap switch. The built-in voltmeter tells you at all times the exact voltage being delivered to your TV. I recommend setting the voltage at about 112 volts to allow for any upward line

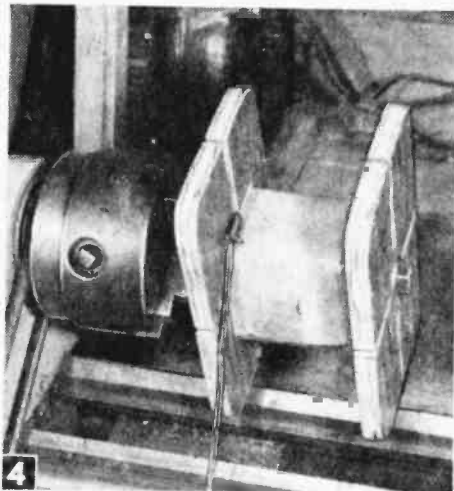

Start winding through slot in narrow side of form. Turn counter records number of windings.

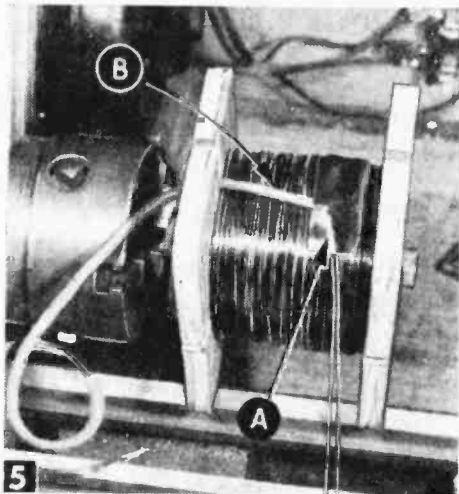

Bringing out loop tap at 247th turn. Slip sleeve over loop and separate lead from rest of windings with electrical tape, top and bottom. Continue winding over tap loops.

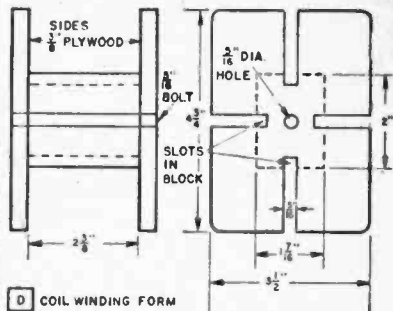

fluctuations. Most electric lines deliver voltage that varies only two to four volts although the general level may be low. No. 1 tap shows direct line voltage on the meter and allows you to check incoming voltage before making any corrections. Each additional tap boosts voltage about two or three volts. Most console TV sets draw about two amperes, well within transformer capacity.

To start building the transformer, you'll need the core taken from an old radio power transformer like an early Silver Marshall or any type close to specified core size (Fig. 4). The stacked E-type laminations measured 4 1/2 x 4 in. outside with coil window openings of 3/4 x 2 1/2-in. with 1 1/2-in. wide center leg and stacked 1 1/16-in. high. If salvage cores are not available, you can cut 1 1/2-in. wide strips out of regular 26-29-gage silicon transformer steel (Fig. 3C). Alternate stacks of four laminations were used in building the core; this same system for covering the joints should be used in rebuilding the core around the new coil.

The new coil consists of 292 turns of either one #17 Formex wire or two #20 wires in parallel. Build a winding form first (Fig. 3D). Leads are brought out on the narrow sides of the form (Fig. 5) to avoid interference when coil is slipped onto the

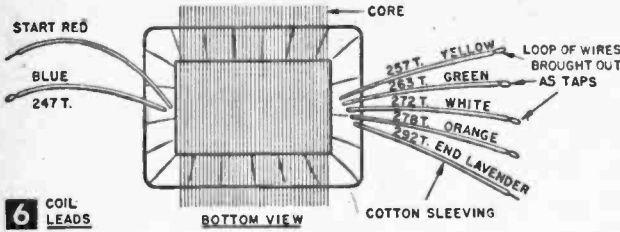

7

Wound coil ready for taping and varnishing. Start and 247th turn comes out left side and 257th to 292nd turns come out right.

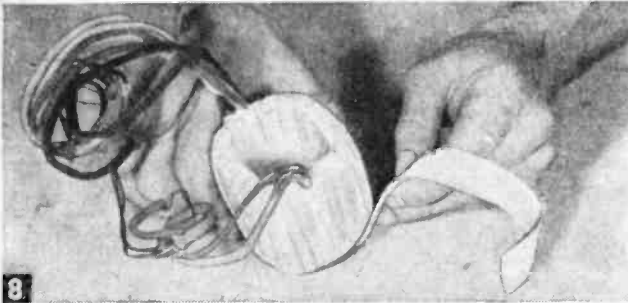

8

Wind cotton coil tape tightly through center opening, cutting strings that hold coil together as you come to them, and sew end.

core. Slots in the form allow you to pass strings through the coil and tie it tightly after winding. A $\frac{5}{16}$ -in. bolt holds the form together and is chucked in the lathe for winding. Cover the core with a piece of armature slot insulating paper secured with cellophane tape. The ends of the two #20 wires were passed through an 8 in. piece of cotton sleeving and started in to the form slot at one of the narrow sides. Wrap

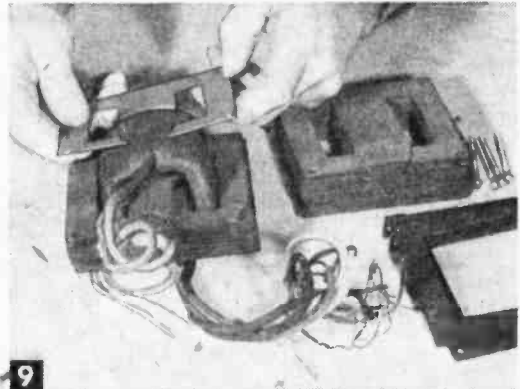

9

Assembling laminations. Reverse positions of laminations every fourth piece to cover butt joints.

the ends of the wires around the chuck jaws to keep them out of the way. The turn counter fixed to the lathe bed and driven by a rubber vacuum cleaner belt keeps track of the windings. You can, of course, wind the coil onto the form by hand evenly spacing the loops in tight layers.

Wind 247 turns before bringing out an 8 in. loop, also covered with sleeving. To identify the different loop leads, cover each with sleeving of

MATERIALS LIST—VOLTAGE BOOSTER

- 1 metal cabinet, Insuline Corp., gray hammertone aluminum 9 x 5 x 6" #29801
 - 1 panel meter, $\frac{3}{2}$ " round, 0-150 volts A.C.
 - 1 core from an old radio power transformer
 - 1 power tap switch, Ohmite model #111, 6 taps, 10 amps.
 - 1 toggle switch, S.P.S.T. 6 amps at 115 volts
 - 1 power receptacle, Amprenol type 61-F1 two pole with plate
 - 1 fuse holder, panel mounting, Buss HKP
 - 1 fuse, Littelfuse 3 AG 5 amps, #312005
 - 1 dial with knob, National HRS-3
 - 1 piece cabinet back screen stock, 9 x 6"
 - 7 ft. 2-wire #18 line cord
 - 1 attachment plug cap
 - 1 rubber grommet for $\frac{3}{8}$ " hole
 - 4 rubber base knobs with 8-32 studs, nuts
- About $\frac{3}{4}$ pound #17 Heavy Formex magnet wire, or double #20 wires. Coil tape, cotton sleeving in several colors, screws, nuts

10

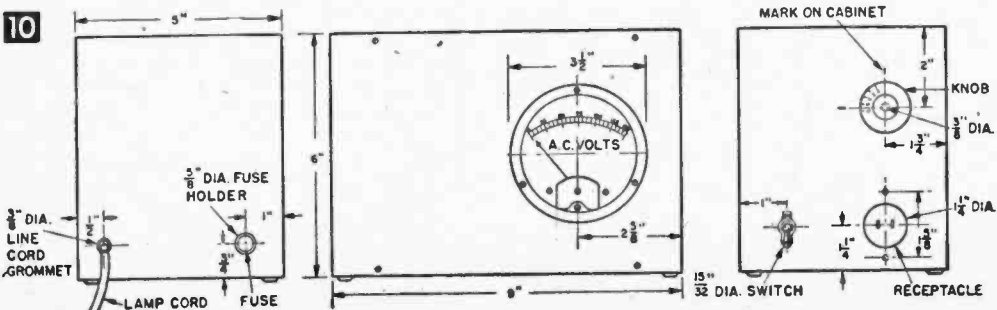

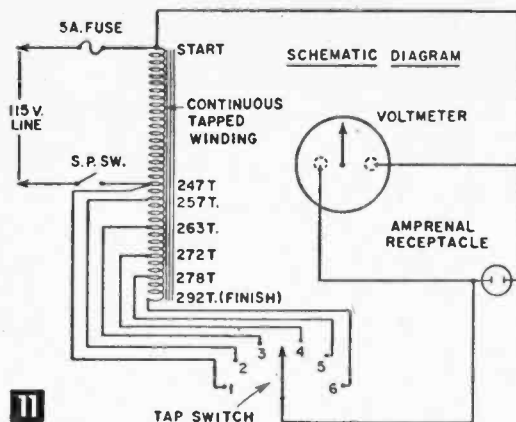

11

a different color noting the turns each represents as the winding progresses. At the loops, which will become taps, place a small piece of Scotch #33 insulating tape under the point where the wire is looped off and another piece on top of the spot, to properly insulate the crossing of wires. Also be sure to use a piece of sleeving over the ends brought out. Continue to wind over the previous work to the 257th turn, and bring out another loop. This 257th tap is brought out at the opposite narrow side of the form from the beginning and 247th tap. Continue to wind in the same way, bringing out taps at the 263, 272, 278, 285 and the end or 292 turns, all on the same form side as the 257th tap.

With the last winding on, you're ready to tie the coil with strings through the slots and remove it from the form (Fig. 7). The starting wire and 247th turn are at one of the narrow coil sides and the 257 to 292nd taps are at the other. Tape the entire coil with cotton coil tape as shown in Fig. 8. Sew the end of the tape before dipping the whole coil in air-drying insulation varnish, allowing it to soak for about five minutes. Hang it up to drain and allow it to dry overnight, or bake in an oven at about 150° F

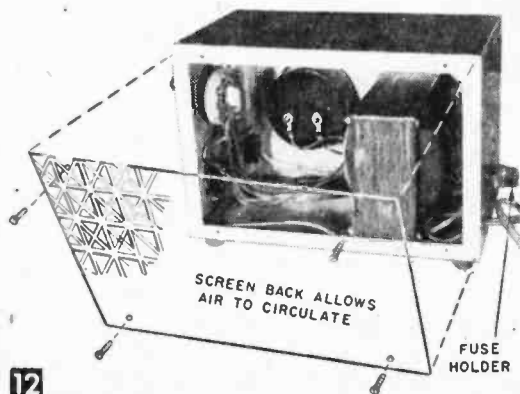

12

Back side of booster assembly. Voltmeter is set off center to clear transformer. Back screen allows air to circulate around transformer. Note fuse holder at right lower corner.

for several hours to fully dry the varnish.

Assemble the core to the new coil (Fig. 9). Drive strips of fiber or Bakelite between the coil and center leg at both sides to wedge it tightly in place. Otherwise, an annoying hum may result. Attach the side frames and the transformer is finished. It will be necessary to square up the core with a light hammer, driving butt joints together.

The grey enamelled aluminum cabinet has removable side panels and is laid out for the holes to mount parts according to Fig. 10. Cut the large holes with a Greenlee chassis punch, a hole saw or fly cutter. Instead of one of the panels, cut a piece of mesh screen stock to fit at the back. Mount the voltmeter, the toggle switch, flush receptacle, transformer and tap selector switch in the cabinet.

When all components are installed, you're ready to wire up connections according to the schematic diagram (Fig. 11). Insulation on the Formex wire is hard to scrape off, so be sure you get down to the bare copper before hooking it up. Use #18 flexible insulated wire for all hook-up connections aside from the transformer tap connections.

Step #1 on the tap switch shows the line voltage on the booster's meter and tells you if it is high enough (112-115 volts) to use without boosting. Other steps increase voltage and meter records just what these voltages are for top TV reception.

Ventilate Your TV Set

Television sets develop a lot of heat and sometimes the only provision for ventilation is a series of holes punched in the back panel. Continued overheating can shorten the life of those costly television tubes.

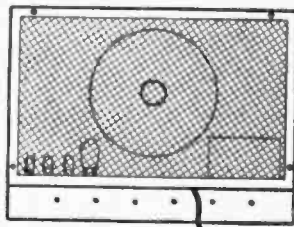

To get more ventilation, replace the panel with a simple frame covered with plastic screen such as is shown above.—W. H. McCLOY.

Pointed-End for Radio Ground Pipe

A simple pointed end makes it easier to drive a radio ground pipe. Insert the lathe-turned point into the bottom end of the pipe to keep dirt from plugging the pipe. Holes drilled through the pipe for soil wetting reduce electrical resistance between ground pipe and soil.—ARTHUR TRAUFFER.

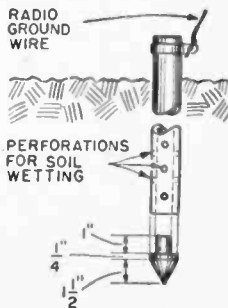

Pocket-Size Tube Checker

With this low-cost tester, you can locate a large proportion of all TV and radio tube failures!

By THOMAS A. BLANCHARD

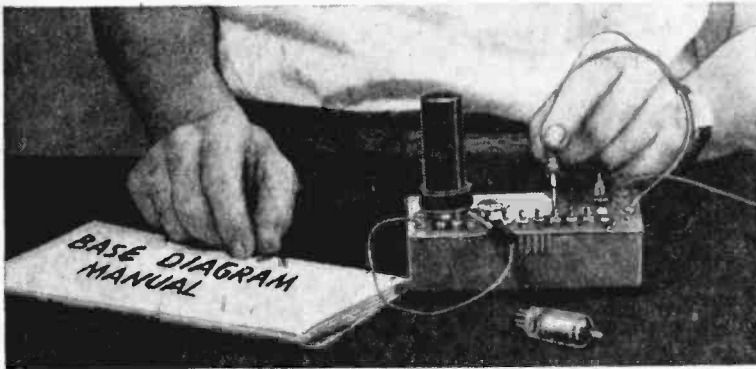

Fig. 1. Tube's condition is determined by reference to base diagram in inexpensive tube manual. Test probes reveal on neon lamp a shorted tube, or tube with burned out heater (filament).

THIS pocket-size TV and radio tube checker contains no meters or complicated parts and it costs just about \$1 to build. Naturally, you can't expect it to compare with a scientific mutual-conductance tester costing \$150. But it can locate most of the current TV tube failures, which are mostly "shorts" between elements, or open heaters (filaments). For the very best TV reception, it's wise to replace all tubes once a year. Save the old tubes as "spares" in case of a sudden tube failure.

This tester will handle all the latest type tubes used in TV as well as ac and battery radio sets made during the last 10 years (except for a few FM radio sets using "locktal" tubes). If you want to handle locktal tubes, you can expand the size of the checker and provide it with 4-, 5-, 6-prong and locktal sockets. The checker consists of a small neon glow lamp and 220,000 ohm $\frac{1}{2}$ -watt carbon resistor provided with a test clip and probe. The neon lamp operates off 115 v.

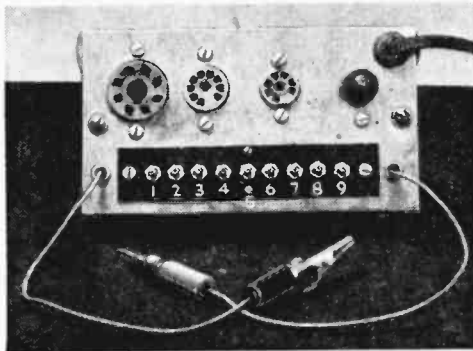

Fig. 2. Front of tester shows test strip, 3 sockets and neon glow lamp which shows tube condition.

a visible glow—(except metal tubes which you can feel to determine whether heater is okay, but don't try feeling tubes in high voltage compartment!) a few tubes are too dim to be seen. TV high voltage rectifiers like the 1B3GT are among those parallel-wired types where this tester is useful. This checker is especially handy in its ability to reveal internal shorts between elements when the tube is cold. The three sockets on the checker are wired in parallel: all #1 socket lugs are wired to Screw #1; Lugs #2 to Screws #2, etc.

ac-dc and provides a continuity check when a tube is inserted into any one of the 3 sockets on the panel. You'll also need a tube base manual which you can get from any radio supplier for from 25c to \$1.

Attach the clip to one of the 9 terminal screws representing a specific tube element as indicated in the base manual. The remaining probe wire is then run along the remaining pins for checking. To determine a burned out "heater," check the basing manual for the heater pins. Many octal tubes are wired with heaters on #2 and #7. Therefore, attach the clip lead of tester to terminal screw #2. Contact the probe lead on screw #7. If the neon lamp glows, the tube filament is okay. Radio and small screen TV sets frequently have series-wired heaters. When one tube "blows," several tubes may go out. This checker is ideal for this test.

While sets with parallel-wired heaters only result in the one bad tube being out—the other tubes usually having

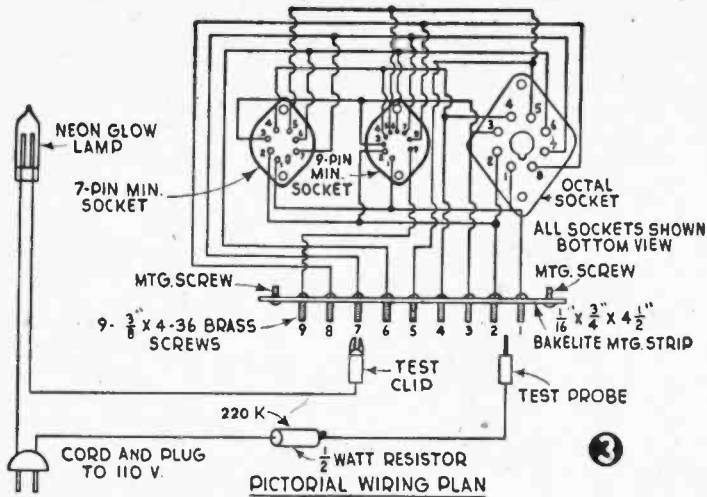

MATERIALS LIST—
TV TUBE CHECKER

- 1—Alum. panel 14 gage 3x4 1/2" (optional)
- 1—Bakelite strip, 1/16x3/4x4 1/2" (only needed if checker is built on metal panel)
- 11—3/8 by 4-36 brass screws, 9 used for test pins; 2 as mtg. screws
- 11—4-36 nuts
- 1—Each: Insulated alligator test clip, and phone tip
- 2—rubber grommets for 3/8-in. dia. holes
- 1—180,000 or 220,000 ohm, 1/2 watt carbon resistor
- 1—NE51 neon glow lamp, 1/2, watt (1/2 watt neon with pigtail leads may be used.)
- 1—6 ft. fixture cord and plug
- 1—Tube base handbook (RCA Pin-dex about \$1)

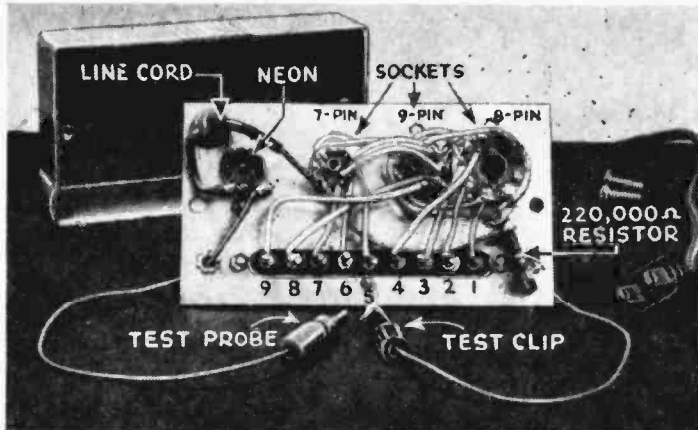

Fig. 4. Bottom view of tester. All alike tube base numbers are connected together to screw having same number on test strip.

Thus, referring to the basing manual, place the clip lead on a heater screw. With the remaining probe, check the cathode (K) screws. If neon glows, tube is shorted from heater to cathode. Next, place clip on cathode screw (number determined by basing manual) and check G¹; then check G¹ and G², then G² and G³, and then G³ and P (plate). Finally, check P and IS (internally connected shield—if any shown on basing diagram).

Remember that if neon does *not* glow on H-H, the test tube is burned out and no good. If neon glows on any test other than that on the heater, it indicates a short and tube is also discarded. In the latter tests between grid, plate, cathode, diode, or the internal shield, observe the basing plan carefully. Some tubes may have a grid, for example, terminated on two pins, say 3 and 5. Naturally the lamp will glow if probes are on Screws 3 and 5 and this does not indicate any defect whatsoever.

Some tubes have an internal shield (IS) and suppressor grid (G³) internally connected and brought out to a common tube pin. But in your

tests, just watch the reaction of the neon glow lamp in pin-to-pin tests between isolated elements shown on the base diagram.

This checker was assembled on a panel of 3 x 4 1/2-in. 14-gage aluminum (Figs. 2 and 4). Drill holes for the 1-in. dia. octal socket, the 3/4-in. dia. 9-pin miniature socket, and the 5/8-in. dia. 7-pin miniature socket. Provide a 5/16 x 3 1/2 in. slot across the panel for clearance of the test pins. These pins are 3/8 by 4-36 brass screws spaced 3/8 in. apart on a 1/16 x 3/4 x 4 1/2-in. Bakelite strip.

Next drill two 3/8-in. holes in the panel for the rubber grommets; one grommet provides a mounting for the small neon glow lamp, while the other serves as insulation for the fixture cord. Make a 1/4-in. hole on each side of the test strip for the test-probe leads.

The sockets used on the tester shown here are Amphenol molded Bakelite types. While wafer sockets may be used, the molded sockets have the pin numbers right on each socket so that there is minimum chance of wiring errors. As previously stated, these socket numbers all wire to the corresponding screw number on the test screw-pin strip. The aluminum panel isn't a must—you may build this tester in any size or shape con-

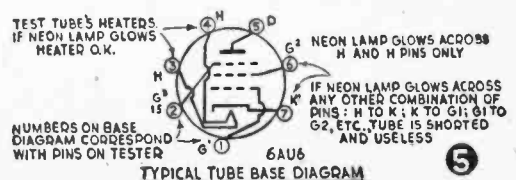

tainer that may be available.

In using your tester always hold the test tube by the insulated plastic grip. While this tester is 100% shockless, the neon lamp is so sensitive in its response that holding the metal test leadtips—one in each hand—will cause the lamp to glow brightly. Standing on a cement floor and holding just one test lead will produce a medium glow.

While a dead short between tube elements usually produces a brilliant glow, a medium glow denotes an inter-electrode capacity breakdown, gassy tube, etc. An extremely feeble, almost invisible neon lamp glow usually indicates that the tube may be used, but you should have it checked at your radio dealer, on his mutual-conductance tester if he has one.

Amateur Radiotelephone Station



By C. F. ROCKEY,
W9SCH

You'll be talking on the 160-meter short wave band with the other "ham" operators from your own "shack" and under your own call letters with this simple radiotelephone station.

IF YOU built a "novice" class radiotelegraph amateur radio station and want to step up to a general class operator with a "voice" station or want to jump directly into your own "ham" station, this combined receiver-transmitter will get you started with little cash outlay. If you bought all the parts new, they'd cost up to \$70, but using junk parts from broadcast band receivers or surplus outlets, you can possibly get by for as little as \$25.

Anyone can enjoy the fun of operating their own amateur radio station, providing they are a citizen of the United States and obtain a license (see box) from the Federal Communications Commission (FCC).

Operating in the "160-meter" band allows you to get good results without too much tinkering. In this low-frequency band you won't be competing with so many high-powered stations, many parts from broadcast band receivers can be salvaged for use and only a simple antenna is required that can usually be squeezed into nearly any backyard without sacrificing too much effectiveness.

While this is not strictly a "long distance" outfit, wave propagation conditions control the distance you can reach more than set design. Weather is a big factor in wave propagation as well as geographical location. But you can reach up to 200-300 miles often enough to make life interesting, and good contacts up to 30

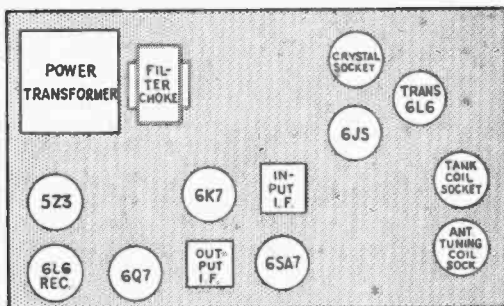

2 General chassis layout for sockets and large parts.

miles are normal.

This unit is a complete amateur radio station and includes an effective 4-tube superheterodyne receiver with a plate-modulated radio transmitter of about 15-watts power input. Nothing else is needed except a PM speaker, microphone and battery (dry cells) and antenna system, which would be required for any radiotelephone installation. If the chassis is placed in a cabinet, the back must be left open for ventilation.

This set was designed with a special view toward using "junk box" parts. Many old radios of late 1930 vintage are available in secondhand stores for a song, particularly if the cabinet is marred or some minor defect exists.

MATERIALS LIST—RADIOTELEPHONE STATION

| Reqd. | Material | Reqd. | Material |
|--------|-----------------------------------------------------------------------------------------------------------------------------------|-------|------------------------------------------------------------------------------------------------------------------------------------------------------------------------------------------------------------------------------------------------------------------------------|
| 1 | chassis, par-metal type Q-4534, 3 x 11 x 17 in. | 9 | 4000 MMF. "postage stamp" mica capacitors, 500 v. |
| 2 pcs. | sheet plastic, 1/4 x 2 1/2 x 4 in. | 4 | 47 K, 1 watt carbon resistors |
| 7 | binding posts, I.C.A., No. 617 | 1 | 22 K, 1 watt carbon resistors |
| 6 | knobs, I.C.A. No. 1274 | 1 | 1 Meg., 1 watt carbon resistor |
| 1 | dial, I.C.A. No. 139, 2 3/4 in. dia. | 1 | 100 K, 1 watt carbon resistor |
| 2 | plug in coil forms, plastic, 4 prong, I.C.A. #1051 1 5/8" d. | 2 | 470 K, 1 watt carbon resistors |
| 6 | octal chassis mount tube sockets, amphenol No. 77-MIP-8 | 1 | 15 Meg., 1 watt carbon resistor |
| 5 | four prong chassis mount tube sockets, amphenol No. 77-MIP-4 | 1 | 200 ohm, 5 watt, wire wound resistor |
| 1 | five prong chassis mount tube socket, amphenol No. 77-MIP-5 (for crystal holder) | 1 | 10 K, 5 watt, wire wound resistor |
| 1 | miniature porcelain lamp socket | 2 | 140 MMF. midget variable capacitors, BUD, No. MC 1856 |
| 1 | four-pole-double-throw wafer switch Centralab #1450 | 1 | 50 MMF. midget variable capacitor, BUD, type No. MC 1853 |
| 1 | power transformer, having secondary windings as follows: 350-0-350 volts, 110 MA. 6.3 volts, 4.5 amperes 5 volts, 3 amperes | 1 | PM type loudspeaker, 5 in., Quam type 5 A1. (Cabinet suggested might be I.C.A. No. 3988.) |
| 1 | filter choke, 10 henries at 110 MA. Merit, type P-3153 | | Also: Screws, nuts, hookup wire, No. 22 D.C.C. magnet wire, rosin core solder, ant. wire, insulators, line cord, plug. |
| 1 | output transf., universal type, 24 w. Merit, #A-2905 | | Tubes required: Metal tube types preferred in all positions, however "G" or "GT" tubes will do except for 6L6 types. These must be either large "G" or metal tubes. The "GT's" will not get rid of the heat fast enough in transmitter use. 1 each 6SA7, 6K7, 6Q7, 6L6, 5Z3. |
| 1 | 455 kc. input I.F. transformer, Meissner, No. 16-6658 | | |
| 1 | 455 kc. output I.F. transformer, Meissner, No. 16-6660 | | |
| 1 | Dual 8 MFD. 450 W.V., electrolytic cap., GL 450-8-8 | | |
| 7 | 0.01 MFD. tubular paper capacitors | | |
| 1 | 0.1 MFD. tubular paper capacitor | | |
| 1 | 10 MFD. electrolytic capacitor, tubular, 50 W.V. Aerovox "Dandee," type PRS. | | |
| 5 | 50 MMF. "postage stamp" mica capacitors, 500 v. | | |

The manufacturer's names and part numbers are given here for convenience of identification only. Equivalent types by other manufacturers will perform equally well. Parts actually used may not look exactly like those specified but will give equal satisfaction, if of correct specifications.

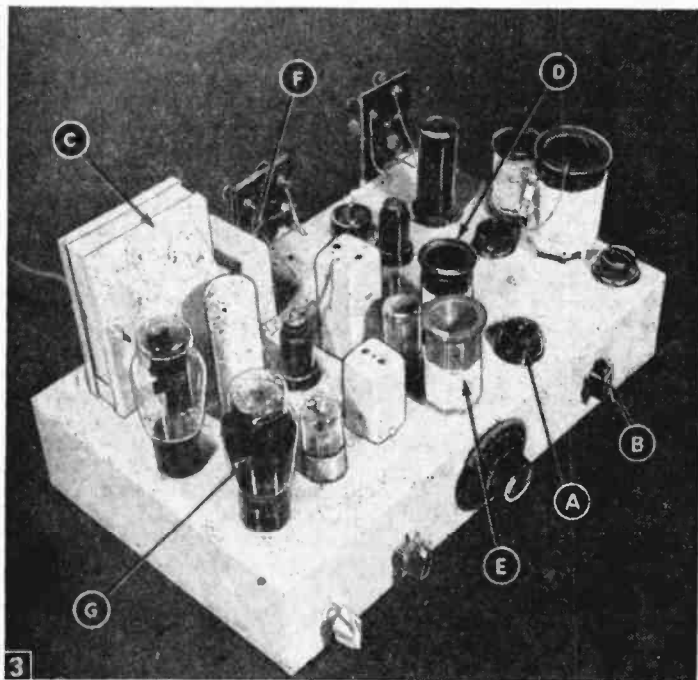

Plan view of the chassis with receiving section in the foreground. Key, A—Receiver-oscillator band-set knob. B—Receiver-mixer tuning capacitor knob. C—Power transformer. D—Receiver mixer coil. E—Receiver oscillator coil. F—Filter choke. G—Receiver 6L6.

(instructions later on) should be reasonably remote from the receiver section. Direct current, heater leads and power-line wiring are not critical and may be wired according to convenience. Keep all leads close to the chassis, however. The parts layout shown (Fig. 2) can be used as a guide, but other arrangements will be satisfactory if they follow the above principles for efficient operation.

First mount all tube and coil sockets using 1/32 x 3/8 in. screws (longer screws should be cut off after tightening). The power transformer, filter choke and output transformer

are mounted next. Leave space for microphone input transmitter to be added later on. The only one of this group which is critical as to chassis position is the microphone transformer. This mike transformer should be mounted at least 5 in. away from the power transformer with its iron core at right-angles to the core of the power transformer to prevent "hum" pickup. The intermediate-sized parts: I.F. transformers, dual electrolytic capacitor, switches, volume control and tuning capacitors should be mounted next without knobs.

Now you can make and mount the two plastic

Such sets are treasure-troves for projects such as this. The only requirement is that the parts used have the right physical and electrical properties. "War surplus" parts are good too. Unless you want a fancy appearing set and have the equipment to punch or drill large holes, I'd suggest salvaging an 11 x 7 x 3 in. chassis from a junked radio receiver. Many times such a chassis will have enough holes for proper parts placement (Fig. 3) without punching more holes. Parts should be mounted so that grid and plate connections to all tubes will be reasonably short. The set's transmitter section

terminal-boards. The first board contains four binding-posts—two for speaker output and two for microphone circuit (see Fig. 4). The second board contains three binding-posts—for the transmitting antenna, transmitting ground or counterpoise and for the receiving antenna. In addition, it contains the miniature lamp socket for the antenna tuning lamp. The smaller capacitors and resistors are "hung by their leads" in the wiring, as is customary in radio apparatus today. Solder all connections carefully, using rosin core solder only. No pastes should be used.

When wiring any radio set some kind of system is necessary if discouraging and part-wrecking errors are to be avoided. It is best to wire the 110-volt power transformer primary connections first, following with connections to all tubes keeping wires close to chassis. Then insert the tubes in their proper sockets, plug in the line cord and turn the switch on.

All tubes should warm up properly. Glass tubes will light up, metal tubes become noticeably but not dangerously warm to the touch in a minute or two. In the event any tubes do not warm up, re-check wiring carefully, particularly chassis grounds and pin numbers. If this fails, test the tubes.

Continue by wiring the power supply, marking-over each lead in the diagram with pencil as it is placed in the set, to further check against errors. When the power supply is finished, test as follows: Take out all tubes but the 5Z3 rectifier and turn on the current. Then turn it off and immediately take an insulated (be careful!) length of wire and short-circuit the last filter capacitor. If wiring is correct, the charge retained in the two capacitors will pass through the wire with a loud, snapping spark. This does no harm, as the rectifier tube is cold and inactive. This test indicates only the pres-

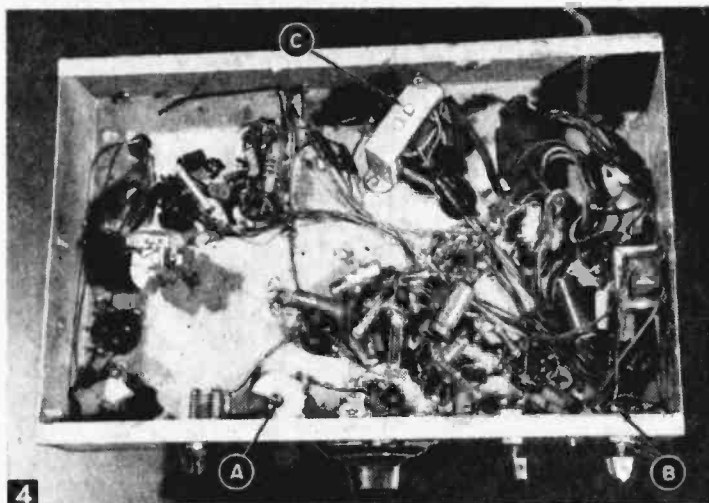

Underside of chassis shows wiring grouped for receiver and transmitter with all leads close to metal chassis. Key, A—Receiver-oscillator band-set capacitor. B—Transmit-receive switch. C—Speaker output transformer.

ence of "residual" energy in the capacitors. However, if you are so fortunate as to possess a 0-500 voltmeter of the radio-servicing type, you may test the output of the power supply with it—a preferred method, where possible. Do not leave unit on.

With the power supply finished, and working, wire next the 6L6 A.F. power amplifier, and that portion of the "send-receive" switch associated directly with the receiver. (Don't forget to pencil the diagram.) This will connect all switch connections except those marked "S" in diagram. In the event you are confused about connecting the speaker output transformer, consult the instruction sheet the manufacturer packed with it. Connect the output transformer to furnish 3000 ohm primary impedance.

Continue by wiring the 6Q7 first audio amplifier including the volume control. When this has been done, insert the 6Q7, 6L6 and 5Z3 tubes, connect the loudspeaker, and plug in the power connection. When the tubes have warmed up sufficiently, advance the

WARNING

You must have a "General Class" amateur license from the FCC to legally operate this radiotelephone station. "Novice Class" licenses will NOT do.

HOW TO OBTAIN YOUR LICENSE

Your General Class amateur operator license also gives you a station license with your own call letters. You must satisfy the local FCC Field Engineer that:

1. You are a citizen of the United States of America, either naturalized or by birth.
2. You can speak, write and understand the English language well enough for practical radio-communication use.
3. You can send and receive the Continental Radiotelegraph Code and can transcribe it at a rate of 13 five-letter words per minute. You must be able to demonstrate this ability by examination (even if you do expect to use voice exclusively).
4. You must demonstrate by written examination a certain minimum understanding of basic radio theory, simple mathematics and U.S. radio law.

There are no fees of any kind and no restrictions as to age, sex or background—as long as you are a U.S. citizen. If you are physically disabled or live more than 125 miles from an examining point, arrangements may be made for taking the examination with a qualified individual approved by the FCC in your area. Otherwise you must take the examinations in person at the FCC radio supervisor's office.

Complete information concerning how to learn the code most effectively, a set of sample "theory" and radio law exam questions for study and other details helpful in acquiring a license may be obtained at a modest fee from the American Radio Relay League, 38 LaSalle Road, West Hartford, Connecticut. They can also supply you with information on times and places for amateur license examinations in your vicinity. The League is the national amateur organization and is pleased to help the new "ham."

By building this receiver section first, you can acquire practical experience which helps you prepare for the license examination and get ready to go directly into building the transmitter section to be described later on in this article.

Adjust the trimmers for maximum voltage output. The meter should register a few tenths of a volt with volume control "wide open."

If you can't find a signal generator, connect an antenna to the receiving antenna terminal instead. Now mark one of the trimmer capacitors in the input I.F. transformer and do not disturb this marked trimmer during any of the following adjustments. Next, manipulate the oscillator band-set and the mixer tuning capacitors until a signal of some sort is received. (This should be possible anywhere in the United States after dark, with a 30 to 50-ft. antenna.)

When a signal is received (any will do, but the steadier the better) carefully adjust the unmarked trimmers for maximum volume. Although not as exact as the signal-generator method, this procedure will provide satisfactory alignment, if done with care. In the event no signals can be received with even a long antenna attached, make sure that the volume control is in the "full on" position and that the send-receive switch is properly set. Then carefully re-check the wiring, coils and tubes.

With the amplifier aligned, you're all set to receive signals. Connect the receiving antenna, and set the main tuning capacitor (50 *mmf* variable) to maximum capacity (plates fully meshed) and slowly turn the 140 *mmf* "oscillator band set" capacitor throughout its range. Meanwhile, with the other hand adjust the 140 *mmf* "mixer tuning capacitor" for maximum noise and hiss. Unless you live in a very poor radio location, you will probably have tuned through several radio signals of one sort or another by this time. With the oscillator band-set capacitor set somewhere between $\frac{1}{2}$ and $\frac{3}{4}$ of maximum capacity, and the mixer tuning capacitor set at about $\frac{1}{2}$ to $\frac{3}{4}$ maximum, you should hear the large city police calls. Radiating considerable power, and operating just outside the lower limit of the 160-meter amateur band on 1714 kc they are convenient "radio landmarks" for setting up your receiver. With your band-set capacitor adjusted as described here, you should find the amateur stations easily on the main

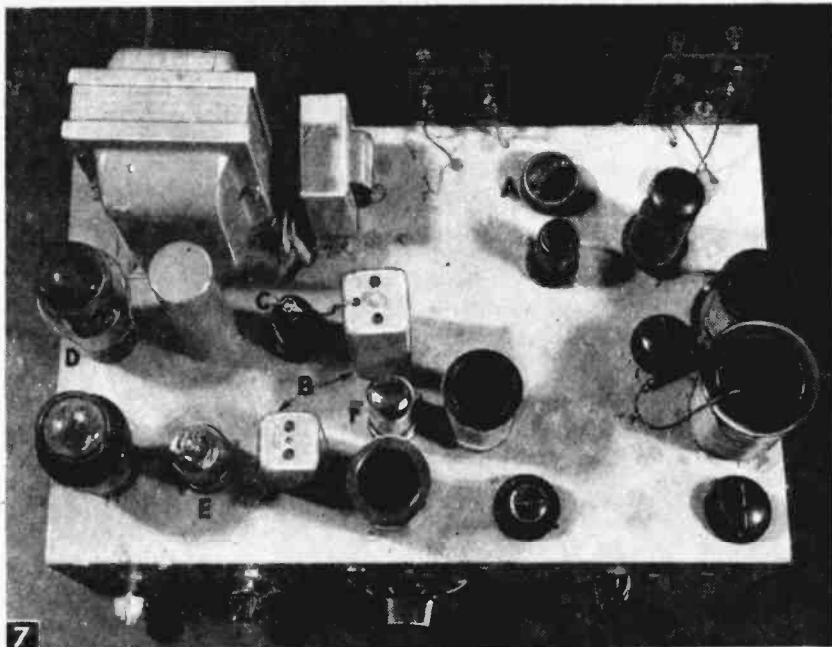

Top of chassis (A) Transmitting crystal holder, (B) I.F. transformers, (C) 6K7 tube, (D) 5Z3 tube, (E) 6Q7 tube and (F) 6SA7 tube.

tuning dial. A slight "touching-up" of the mixer tuning capacitor will bring in particular stations at maximum volume. If, among the amateur stations, you run across a very loud, buzzing signal, do not be alarmed. That is merely one of the Loran radio-navigation stations which share this band with the hams.

Spend several hours listening to the various 160-meter amateurs audible in your locality; acquire practice in the best use of the receiver. You will also learn the calls of many of the stations with which you will later communicate, their operating hours and something of the propagation characteristics of radio waves in this band.

Building the Transmitter Section and Getting "On the Air"

When you receive your license from the FCC, you're then ready to talk with all the other "hams" within the set's operating radius on the 160-meter band.

The FCC has assigned amateur frequencies in the 160-meter band on a geographical basis.

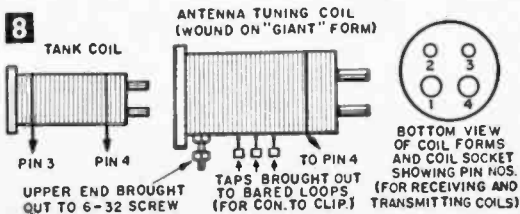

TABLE A—CRYSTAL FREQUENCIES ASSIGNED BY FCC (Correct at the time of writing but is, of course, subject to change without prior notices.)

| Area | Assigned Band, Kilocycles |
|----------------------------------------------------------------------------------------------------------------------------------------------------------------|---------------------------|
| Minnesota, Iowa, Arkansas, Missouri, Louisiana, and all states EAST of these states and the Mississippi River, including Washington, D. C. | 1800-1825 1875-1900 |
| North and South Dakota, Nebraska, Colorado, New Mexico, and all other states WEST of these states and the Mississippi River except Texas, Oklahoma and Kansas. | 1900-1925 1975-2000 |
| Puerto Rico and Virgin Islands | 1800-1825 1875-1900 |
| Texas, Oklahoma and Kansas | 1800-1825 1875-1900 |
| Hawaiian Islands | 1900-1925 1975-2000 |

Therefore, when buying a crystal for use with this unit, select the frequency from Table A.

Begin wiring the transmitter section at the "transmit-receive" switch (those marked "S" on Fig. 6) and the microphone input transformer. Again, as in wiring the receiver section, it's a good idea to pencil in on the wiring diagram each connection as it is made.

Next, wire the 6J5 crystal oscillator circuit, insert the tube and plug the crystal-holder into its socket. After the tubes have warmed up, switch the "transmit-receive" switch into the "transmit" position and touch the tip of a 2-watt tuning neon lamp to the plate connection of the 6J5 tube (pin #3), being sure to hold only the glass bulb of the neon lamp. A bright red glow in the bulb indicates satisfactory oscillation in this stage. If the neon lamp does not glow, recheck the wiring and position of switch. Crystals are so simple and reliable they seldom fail, particularly in a circuit such as this.

When the crystal oscillator is working, begin wiring the amplifier stage. Connections to the transmitter tank coil are not critical, except that the top end, pin #3, should be connected (through the 4000-mmF capacitor) to the plate of the 6L6 and the lower end, pin #4, should connect to the chassis. Keep the leads to the screen-grid bypass capacitor (4000 mmF from 6L6 pin #4 to chassis) as short and direct as possible to reduce stray noise pickup.

To check the operation of the amplifier stage, insert the 6L6 tube and its coil in their sockets and turn On the power. When the tube is warm, switch to "transmit" position and hold the glass bulb of the neon lamp against the transmitter tank coil. Now rotate the transmitter tank tuning capacitor until a bright red glow appears within the neon lamp, building up to a maximum at a specific position of the capacitor. If there is no glow in the neon lamp, recheck the wiring, the position of the transmit-receive switch and the 6L6 tube. Do not at any time allow the amplifier to run unless the tank tuning capacitor is set for maximum output, or it may ruin the tube and require a replacement.

A 0-100 ma d-c milliammeter is helpful in checking the amplifier stage if available. Connect it into the circuit at the point marked "X" on the diagram (Fig. 6). It should register from 60 to 100 ma at most positions of the tank capacitor, but at the point which corresponds to maximum glow in the neon lamp, the current reading should "dip" down to a much lower value.

Only the antenna tuning circuit and aligning of the set are left to do. The antenna coupling coil, L₄, should be wound closely about the bottom of the transmitter tank coil to effect good coupling. The degree of coupling can be varied by sliding this antenna coupling coil up or down the tank coil.

To put the station on the air, connect the receiving antenna and the loudspeaker the way you did when operating only the receiver section. Connect the transmitting antenna and ground (or counterpoise if used instead). Warm up the tubes and switch to "transmit." Adjust the transmitter tank capacitor for maximum glow in the neon lamp as previously—making sure you turn off the transmitter while making each adjustment. From this setting, clip the spring-clip on the lowest tap of the antenna coil (connecting in the fewest number of turns). Rotate the antenna tuning capacitor until the antenna tuning lamp glows with maximum brilliance. If there's no glow, clip the spring-clip on the next highest coil tap and repeat. You may find that the antenna lamp glows on several taps, so use the connection that shows the brightest glow (greatest antenna current).

When the antenna has been tuned, readjust the tank capacitor slightly, if necessary, to give

MATERIALS LIST—TRANSMITTING SECTION

- | Reqd. | Material |
|---------------------------------------------------------------------------------------------------------------------------------------------------------------------------------------------------------------------------------------------|------------------------------------------------------------------------------------------------------------|
| 1 | sheet plastic (to mount antenna capacitor), 1/4 x 1 1/2 x 1 1/2 in. |
| 1 | plug in coil forms, plastic, 4 prong, I.C.A. No. 1051, 1 1/8 in. dia |
| 1 | large dia. "transmitting" coil form (so called "giant" size). I.C.A. type No. 2670, 2 1/4 in. dia. |
| 1 | spring battery clip, Mueller |
| 1 | microphone input transformer, single button mike to grid of tube. Merit, No. A-2923 |
| 1 | 160 meter band quartz crystal, mounted (See Table A for frequency specifications), James Knight, type H-23 |
| 1 | high output, single button microphone, carbon, American, type FP |
| 2 | 2 1/2 millihenry R.F. choke coils, National R-100 |
| 2 | 140 MMF. midget variable capacitors, BUD, No. MC 1856 |
| 2 | Eveready "ignitor" No. 6 dry cells |
| 2 | G.E. 2-watt standard screw base neon glow lamps (one for spare) for tuning purposes. (See text for use) |
| Also: Screws, nuts, hookup wire, #22 D.C.C. magnet wire, rosin core solder, antenna wire and insulators, line cord and plug | |
| Tubes required: Metal tube types preferred in all positions. However "G" or "GT" tubes will do except for 6L6 types. These must be either large "G" or metal tubes. The "GT's" will not get rid of the heat fast enough in transmitter use. | |

1—6L6 1—6J5

The manufacturer's names and part numbers are given here for convenience of identification only. Equivalent types by other manufacturers will perform equally well. Parts actually used may not look exactly like those specified but will give equal satisfaction, if of correct specifications.

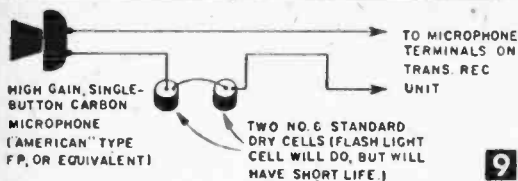

maximum antenna output as indicated on the antenna lamp. When finally tuned, the milliammeter should indicate 50-80 *ma*.

Connect the microphone and microphone batteries as shown in Fig. 9. The microphone used must be of the *single button carbon type*. The crystal type will not work as its signal output is too low. With the microphone and batteries connected, throw the switch to "transmit" and speak into the mike. The antenna current, indicated by the antenna tuning lamp, should definitely increase on voice peaks. If it does, the transmitter is modulating properly and you are ready to go on the air. Be sure to speak loudly enough into the microphone to cause the light from the antenna bulb to fluctuate noticeably. This assures sufficient modulation.

The transmitting antenna system is perhaps the most important part of the whole station as regards the production of strong, reliable signals. While "any piece of wire" at least 50 ft. long may be worked against a water-pipe ground for local contacts, a carefully-erected system (Fig. 10) will widen your contact area. Although the counterpoise is shown as being directly underneath the antenna, this is not strictly necessary. It may be placed anywhere and still work reasonably well (or if a really *good* low-resistance ground is available it may be used instead of the counterpoise). Every inch of wire in the system radiates energy, so keep as much of it as possible

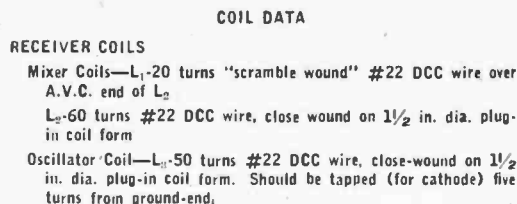

TRANSMITTER COILS

Transmitter Tank Coil— L_1 -10 turns of hook-up wire wound "scramble" over ground-end of L_2

Transmitter Tank Coil— L_2 -60 turns #22 DCC wire, close-wound on $1\frac{1}{2}$ in. dia. plug-in coil form

Antenna Tuning Coil— L_3 -70 turns #22 DCC wire, close-wound on $2\frac{1}{4}$ in. dia. "glant" plug-in coil form. Should be tapped at 10, 20, and 30 turns from antenna end

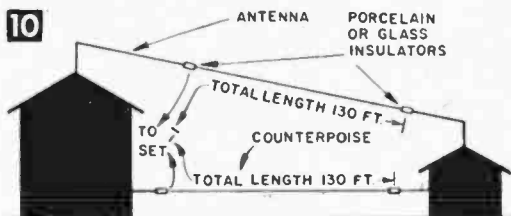

out in the open. The lead-in is as much a part of the radiator as is the "flat top," so don't bury it among a mess of gutter-pipes and lightning rods and still expect it to do a job for you. The length of the system (and this includes every inch of wire from tip of antenna to the very surface of the ground itself, or *one-half* of the length from tip of antenna to tip of counterpoise, if the latter is used) should be not shorter than 75 nor longer than 150 ft.—END.

"40 Meter" Band Operation

AT THE TIME this article was written, 40 meter (7 megacycle) band operation was not contemplated for novices, and since the more advanced amateur would not require such detailed information, there is no specific design data for operating this station on the 7 megacycle band. From basic principles, it is safe to say that the unit will operate on this band satisfactorily if *only the coils are changed*. All other components, including the antenna, will be OK as stated for both the "old" and "new" frequency bands.

The exact design of coils for any high fre-

quency apparatus depends on so many factors that one hesitates to make a general statement and perhaps each individual set would require slight modifications peculiar to itself. On the basis of general principles, we suggest that the new coils for the 7 megacycle, "40 meter" band be wound with the same size wire and on the same size forms but that they contain one-half as many turns as specified for the 3.5 megacycle band on which the set in the article operates. Again, this is a general suggestion and individuals will have to experiment to determine exact values for their particular sets.

Novel Uses for Old Radio Parts

By
R. F. YATES

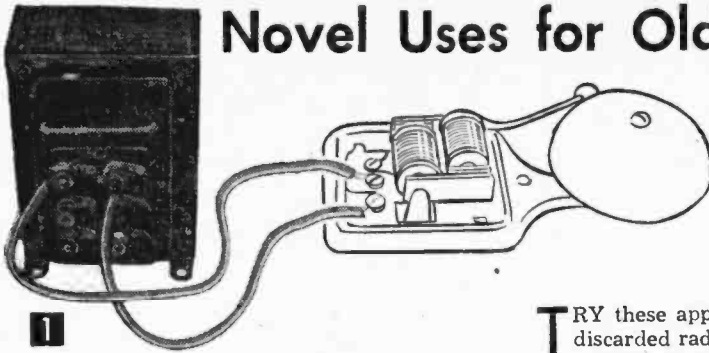

1

TRY these applications for the usable parts of discarded radios:

1. Filament transformers of the older types have tapped secondaries supplying several voltages. The higher voltage (6 to 8) may be used for operating many inexpensive type doorbells and buzzers which work on this low voltage (some new types require 12 to 20 volts).

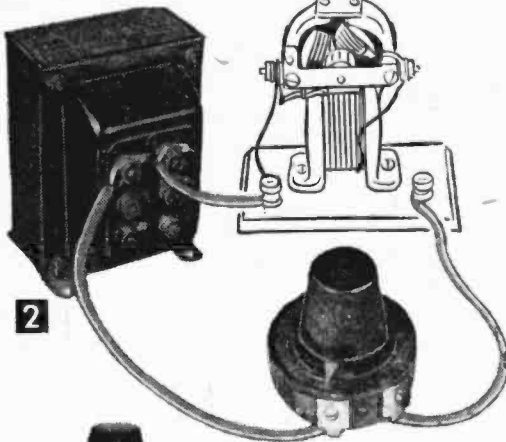

2

2. An old filament transformer and a discarded filament rheostat can be used to operate a toy motor of the series type which is designed for 6 to 12 volt operation.

3. Improved water rheostat using a glass container of salt water and an old brass plate variable capacitor will work well on devices which have a low power drain from the power line. Manipulate the capacitor to regulate current flow.

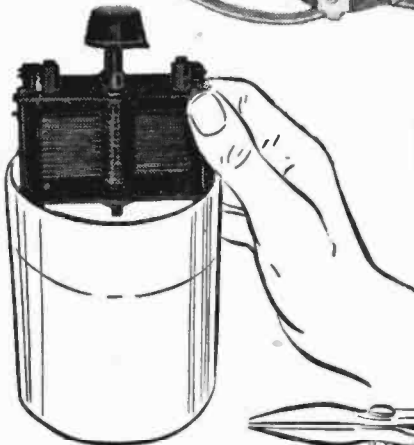

3

4. A powerful ac or dc electromagnet may be made by cutting a piece out of the core of an old filament transformer. The secondary winding is left disconnected, only the primary winding being used.

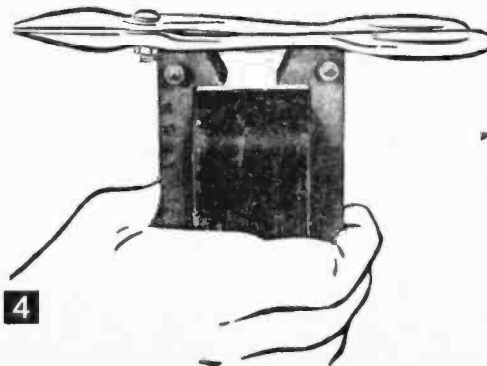

4

5. Old capacitors of the small paper type may be connected across the contacts of electric bells to prevent radio interference when the door bell is operated.

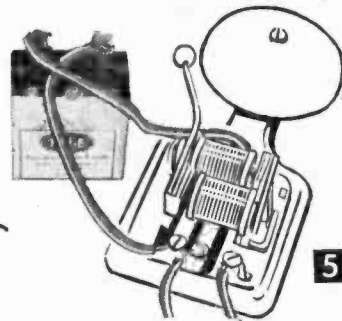

5

6. A dynamic speaker field coil connected to an ac source can be used to de-magnetize a tool.

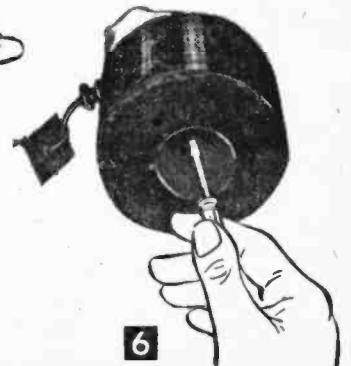

6

—END

T. V. Antenna Coupler

You can operate two or more TV sets from a single roof antenna with this simple R.F. coupling transformer

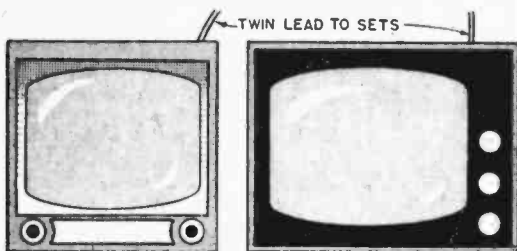
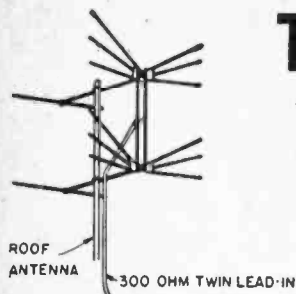

IF YOU have two television sets, this simple coupling device will enable you to operate them from a single roof antenna. Fig. 1 shows a two-set coupler; however, by constructing four R.F. coupling transformers as shown in the schematic (Fig. 2), 3 or 4 sets can use the same antenna.

Actually, when several sets are operated off a single antenna, performance is often better than that obtained with a separate antenna on the roof for each set. The coupler reduces interaction between TV sets operated in close proximity of each other. Tests with this unit showed no loss in signal strength either at the high end (Channel 13) or low end (Channel 2) of the TV bands.

The aluminum panel (Figs. 1, 3 and 4) is slotted to clear the soldering lugs of a 2- and 4-screw terminal strip. The R.F. coupling coils are wound on a single coil form for convenience and

soldered to the terminal lugs in self-supporting fashion (Fig. 3). A coil form salvaged from a discarded I.F. transformer is long enough for both, or they may be wound on individual forms of $\frac{5}{16}$ in. diameter.

The primary and secondary windings of the R.F. couplers (about 30 turns each) are both wound in a single operation. Cut off two 34 in. lengths of magnet wire, and dip the ends of one piece in colored nail polish. When dry, secure an end of each wire in a small hole pierced in the coil form. Apply Duco or similar cement to the coil form and wind the dual lengths of magnet wire in a tight, even layer. Allowing $2\frac{1}{2}$ in. of wire at the end for making connection to terminal lugs, anchor these leads in another pierced hole and set coil aside until cement has set.

Wind the second R.F. coupling transformer in the same manner. When both coils are dry, scrape insulation from the ends of the plain wires and solder to the 4-post terminal strip as shown in pictorial plan (Fig. 4). The primary wires are easily identified by the nail polish. Scrape the insulation from the right-hand red-tipped leads of each coil. Twist these together

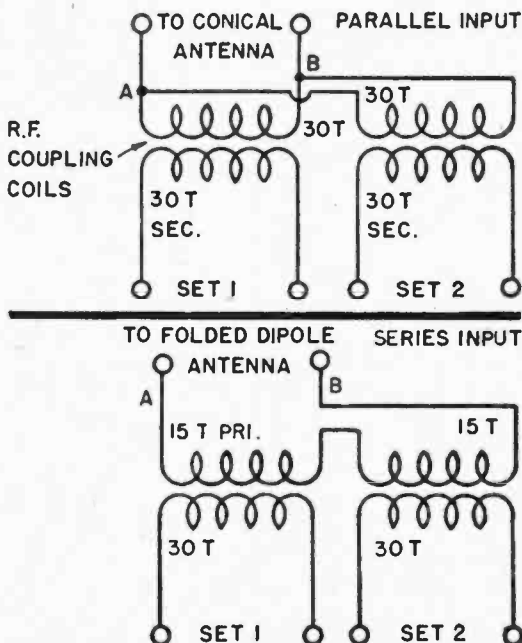

UP TO 4 TV SETS MAY BE ATTACHED TO CONICAL ANTENNA USING ABOVE CIRCUIT IN TANDEM

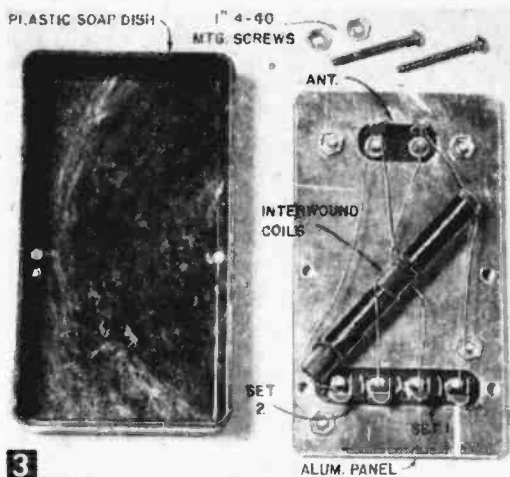

3

MATERIALS LIST—TV ANTENNA COUPLER

- 1 plastic soap case (dime store)
- 1 aluminum panel, 2 3/8 x 4"
- 1 2-post terminal strip
- 1 4-post terminal strip
- 1 1/4 lb. spool #28 enameled magnet wire
- 1 length 3/16" dia. paper or plastic tubing or wood dowel
- 2 1" 4-40 machine screws with matching nuts

and solder to one of the lugs of the 2-post terminal strip. Now scrape off insulation from the two remaining red-tipped coil leads, twist together and solder to remaining terminal strip lug.

After attaching panel to plastic box with two 1 in. 4-40 machine screws and nuts through bottom of the plastic box, the coupler is ready for use. Attach set lead-in to the 2-post terminal strip. Run a short length of 300-ohm lead-in from first set to terminals marked Set 1 on coupler. A longer length of lead-in is then connected from Set 2 on coupler to the second TV set.

The coupler hook-up illustrated is for use with conical or X-type antenna only, which will match any lead-in wire and input (balanced or unbalanced) of any TV set. However, this coupler hook-up should be used only with sets having a 300-ohm input.

The primaries of the coupling coils are connected in parallel. This cuts the input to about 150 ohms for the 2-set coupler, and down to 75 ohms when a 4-set cou-

COILS, 30 INTERWOUND
TURNS #28 ENAMELED
WIRE ON 5/16" DIA. TUBE

2 3/8 x 4" ALUMINUM PANEL

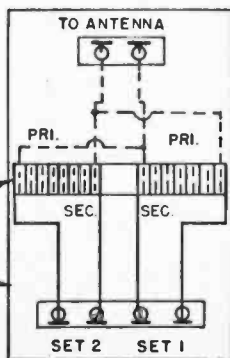

4 PICTORIAL PLAN

pler is employed. There were no noticeable objections to this, but two series units in tandem are best.

If you wish to invest a little more time for a more closely matched antenna input, carefully unwind 7 1/2 turns from each end of the primary coils. This will leave a 30-turn secondary with a 15-turn interwound primary in the center. Now connect the end of the first coupler primary to one of the 2-post terminal strip lugs. Solder the remaining end of this coil to the start end of the second coupler primary. Now solder the finish end of the second coil to the remaining terminal lug. The coils are thus wired in series to provide a 300-ohm match approximately. This hook-up is advised when using the 2-set coupler with a folded dipole or dipole type antenna requiring connection to a 300-ohm input.

To operate sets with 72-ohm coaxial fed inputs, a single coupler transformer with a tapped secondary winding will provide a match to the popular 300-ohm twin lead and conical antenna. Wind a coupler coil with two lengths of magnet wire as previously described. After winding 15 turns, twist a small loop in the red-tipped wire, and complete the windings.

Unwind turns from each end, leaving 15 turns with the loop-tap point in center. Connect the 30-turn coil to antenna posts on coupler. Connect one end of 15 turn coil to first screw of 4-post strip. Clean insulation from tap and solder to terminals 2 and 3. Connect remaining end of coil to terminal 4.

When attaching sets with coaxial lead-in to this coupler, the outer cable shields connect to terminals 2 and 3. The inner insulated wires connect to terminals 1 and 4, respectively.

Where a make-shift or hasty 2-set installation is desired, we suggest capacity coupling. Connect the roof antenna to the weaker of the two sets. Now attach a length of 300-ohm twin lead-in to the second set, and tape 3 or 4 feet of wire parallel with the roof antenna lead-in. Although there is no actual connection between second set and roof antenna, results are frequently very satisfactory.

Solder Clipped to Iron Cord

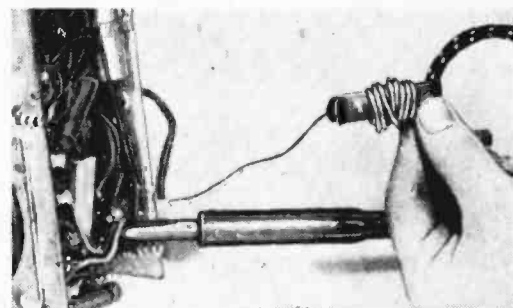

• You'll have no trouble keeping track of rosin core solder if you will purchase a trouser clip at a bicycle store, slip it over the iron cord and wind solder around clip so it can't come off.—H. L.

Pint-Sized Loudspeaker Radio Receiver

By T. A. BLANCHARD



1

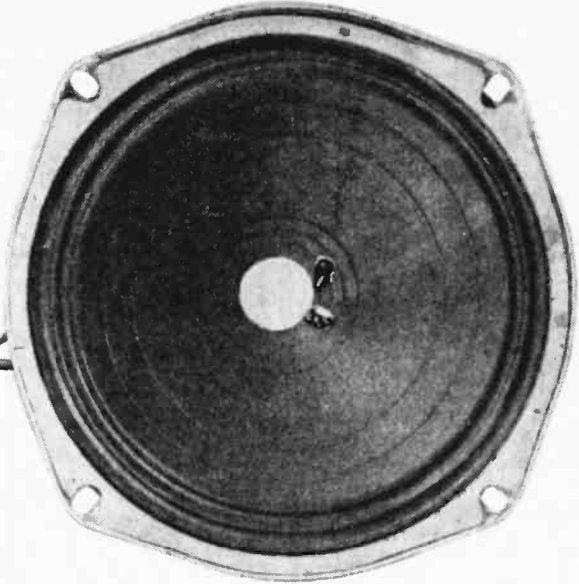

A dual purpose TV tube is the heart of this Lilliputian set which may be operated with headphones or speaker

Tiny set measuring 4 x 4 1/4 x 3 in. deep is dwarfed by small PM speaker it drives at more than normal volume.

ALTHOUGH this tiny radio operates on a single tube (plus rectifier), it has all the loudspeaker volume you'd expect from a much larger and complex receiver. The set is designed to operate any size PM speaker (even 12 in.) and may also be used as a personal set merely by inserting a headset in the rear chassis jacks instead of PM speaker and output transformer.

When you compare the finished receiver with the 6-in. PM speaker as shown in Fig. 1 you'll appreciate its minute size. Yet for all its miniature characteristics, there was no crowding of components on the chassis (Figs. 2 and 5).

The dual triode tube employed is a 12AU7 widely used in TV sets. Half of the tube is the detector in a super-regenerative circuit, while its remaining triode section operates as an A.F. amplifier. The 12AU7 is a miniature tube with a 9-pin base. A miniature 35W4 half-wave rectifier tube supplies the set with the necessary d-c voltage. The heaters of the 12AU7 and 35W4 tubes are wired in series through a 500-ohm voltage dropping resistor, permitting

the set to operate directly off the power line without the use of a bulky step-down transformer.

The model shown uses a 25-watt Mazda lamp for the voltage dropping resistance. A 3-wire series plug connects the set to power outlet. When a 25-watt bulb is plugged into the top of

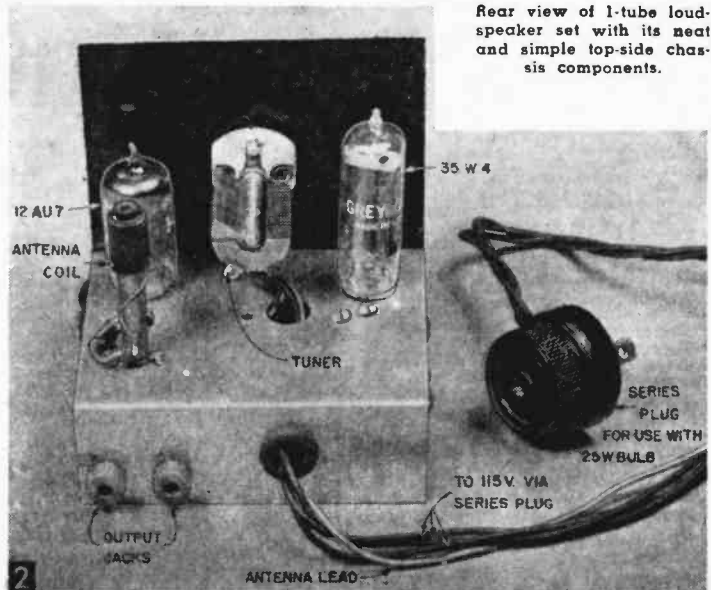

Rear view of 1-tube loudspeaker set with its neat and simple top-side chassis components.

2

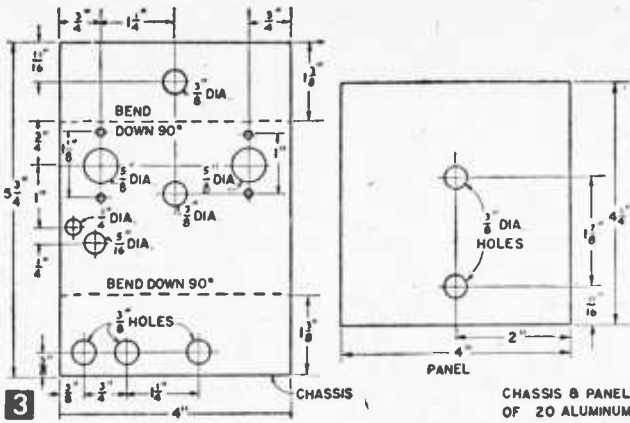

MATERIALS LIST—TINY LOUDSPEAKER RADIO

- 1 pc. #20 aluminum 4 x 5 3/4 in. for chassis
 - 1 pc. #20 aluminum 4 x 4 1/4 in. for panel
 - 1 dial plate and bar pointer knob
 - 1 series tap (for use with 25-watt bulb)
 - 1 7-pin miniature socket
 - 1 9-pin miniature socket
 - 1 pr. headphones or PM speaker
 - 1 output transformer with 5000 ohm primary to voice coil (when operating set with speaker)
 - 1 12AU7 tube
 - 1 35W4 tube
 - 1 antenna coil (Grayburne 51-034)
 - 1 12AU7 tube
 - 1 35W4 tube
 - 1 antenna coil (Grayburne 51-034)
 - 2 phone tip jacks
 - Misc. hardware, hook-up wire
- RESISTORS**
- 1 15-megohm, 1/2-watt resistor
 - 1 27K (27,000) ohm, 1-watt resistor
 - 1 1K (1000) ohm 2-watt resistor
 - 1 480 or 500 ohm, 10 or 15-watt wire-wound resistor (or 25-watt Mazda lamp)
 - 1 0.5-meg. volume control (potentiometer) with S.P.S.T. switch
- CAPACITORS**
- 1 5-50 mmf. trimmer
 - 1 50 mmf. fixed mica or ceramic capacitor, 200 v. or higher
 - 1 .005 or .006 mfd. paper capacitor, 200 v. or higher
 - 1 .01 mfd. paper capacitor
 - 1 tuning capacitor (approximately 360 mmf.)
 - 1 20-20 mfd., 150 v. electrolytic capacitor
- ^aSee text to determine value

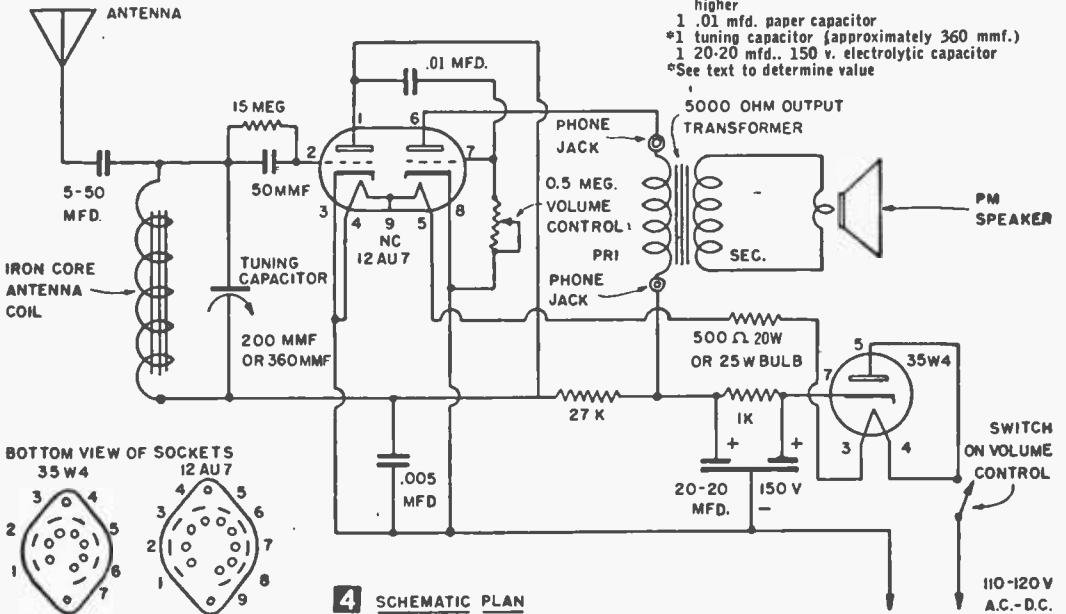

4 SCHEMATIC PLAN

the series plug, the radio is ready for operation. A 20-watt wire-wound resistor may be substituted for the Mazda lamp arrangement.

Form the chassis and front panel from #20 aluminum (Fig. 3). Panel hole for variable tuning capacitor shaft may require changing to match capacitor used. Drill hole after securing capacitor and determine where it is to be mounted. After layout and hole-cutting operations are completed, bend chassis to shape. Note that chassis and front panel require no mounting screws since they are secured by the bushing of the volume control. Wire in components, following the simple schematic plan in Fig. 4, attaching antenna coil and front panel after all under-chassis work has been completed. The model shown uses a 140 mmf. miniature tuning capacitor. However, for complete broadcast band coverage, purchase a standard size 360 or 410

mmf. capacitor. There is ample room between tubes for the larger tuning capacitor.

When using a standard-size tuning capacitor it must, however, be mounted on Bakelite or fiber insulators so that both stator and rotor plates are insulated from chassis. Ordinarily, the rotor plates would ground to chassis. But in a super-regenerative circuit, the tuning capacitor is across grid and plate of the detector tube—not grid and ground as in the case of a regenerative or super-het circuit. Be careful, when mounting tuning capacitor, that the shaft does not contact metal where it passes through front panel.

The antenna is a ready-made component listed in most radio catalogs. Choose a coil listed as a high-Q, iron core or ferrite core type. These coils have either a bracket or snap-in chassis mounting and may be mounted accordingly. A short flexible lead is attached to antenna coil

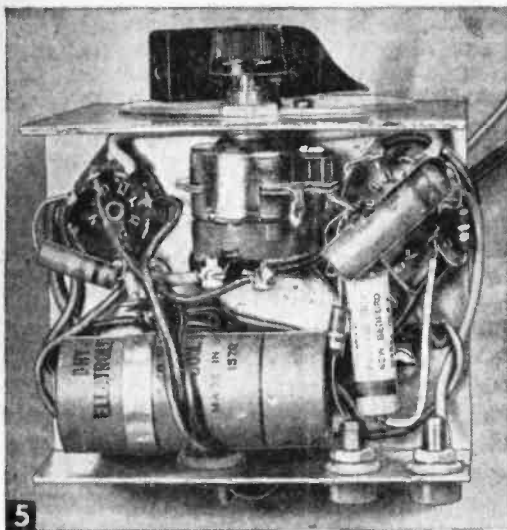

5
Bottom view of chassis with most space being occupied by the 20-20 mfd., 150 v. electrolytic capacitor. Chassis and panel are joined together by the threaded bushing of volume control.

through a 5-50 *mmf.* trimmer capacitor. The set requires very little antenna for good operation. A 2 or 3 ft. length of wire is ample for local broadcasting stations. The antenna lead may be attached to a metal object such as a bed-spring or window screen, for greater pick-up.

Vary the screw adjustment on the trimmer capacitor for best operation. If the set has a tendency to oscillate (whistle), replace the .005 *mfd.* capacitor with a .006 *mfd.* Proper adjustment of the antenna trimmer will also correct the over-sensitive tendencies of this circuit. It is always desirable to have a set of this type adjusted just within the point where it will oscillate for best reception.

If you wish, substitute two pieces of insulated hook-up wire for the 5-50 *mmf.* trimmer. Connect the bare end of one wire to a metal object. Now twist this lead and the wire coming from antenna coil together. The twisted *insulated* wires form a perfectly fine antenna coupling whose capacity is varied by more or less twist—two or three twists usually being sufficient. Greater coupling is achieved by additional twists of the insulated leads.

The metal chassis design used here is not absolutely necessary, as even cigar-box construction will provide good results, assuming wiring is correct. There is little or no "body capacity" effect so that metal chassis or shielding is not an important factor. It's not necessary to ground the chassis to power line through a capacitor to void body capacity effects on the circuit. You may, if you wish, attach a .1 *mfd.* capacitor from chassis to cathodes (pins 3 and 8) of the 12AU7 to bring the chassis to ground potential.

When tube filaments are operated in conjunc-

tion with a 25-watt Mazda lamp, the set's total power consumption is only about 10 watts. Once tubes have reached operating temperature, the Mazda lamp glows at a very low brilliance or about that of a 7-watt night bulb. When the set is first turned on, the 25-watt bulb burns at full intensity for a few seconds, then gradually dims until it has the full heater load across the filaments of the two tubes.

Holder for Soldering Gun

• This convenient holder for an electric soldering gun will protect you and the gun, and can be carried about or mounted permanently on the

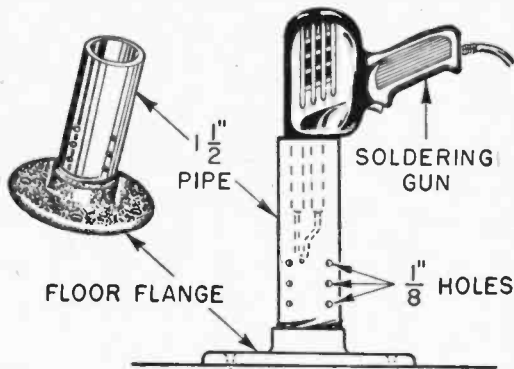

workbench. Drill $\frac{1}{8}$ -in. air holes in a length of $\frac{1}{2}$ -in. pipe, and thread pipe onto a floor flange. Insert the point of the gun into the pipe.—W. B. EAGAN.

Secret Switch for Table Radio

• If you have a table radio you don't want everybody to use, mount a small mercury switch on the radio chassis with a cable clamp, and

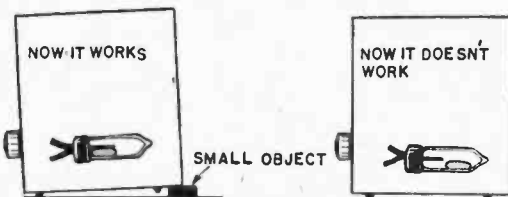
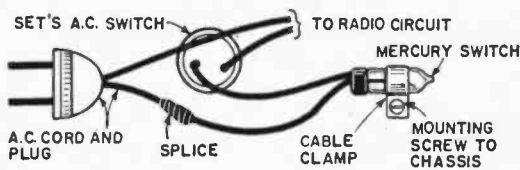

connect the mercury switch leads in *series* with the regular a-c switch. When the radio stands level, the mercury switch should pass no current, but when the radio is tilted forward slightly by placing a small object underneath the rear of the cabinet the mercury switch turns the set ON.—ARTHUR TRAUFFER

Versatile TV Stand

Portability, indirect lighting and a storage drawer make this stand a valuable companion for your TV set

By FRANK HEGEMEYER



four sides of the case. Use a close-grained hardwood finished to match the television case, or to blend with cabinets finished in a solid tone.

Note that the legs have a double taper (Fig. 2A). First make full-length tapers on a jointer with the setup shown in Fig. 2B. Tapering is done by simply lowering one end of the leg onto the rear table while tearing the work, form the tapers in a series of cuts until the 1 1/4 in. square

THIS television stand has a revolving top, a drawer for TV programs, indirect lighting for balancing room illumination with the screen brightness plus casters for easy wheeling to other room locations. The stand, patterned after furniture of the Hepplewhite period, was designed primarily for a 17 in. television set having a case measurement of 20 wide by 20 1/2 in. deep. You can easily adapt it for the larger 20 or 21 in. sets by simply increasing the size of the revolving top in which it is cut, to extend 1 in. beyond all

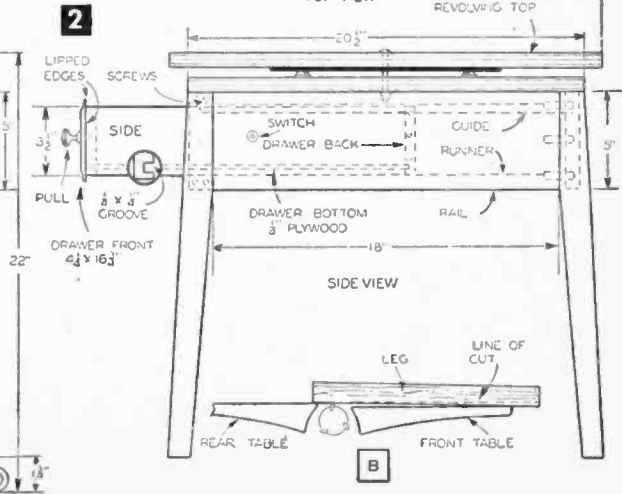
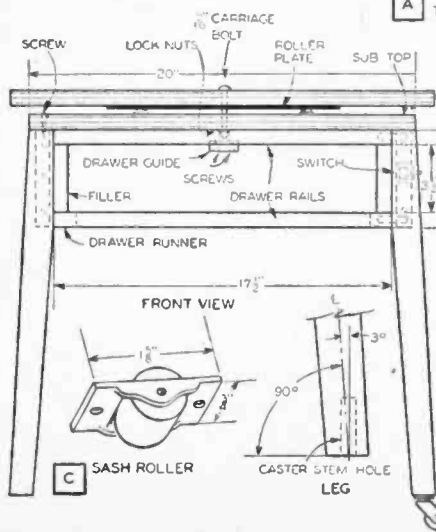
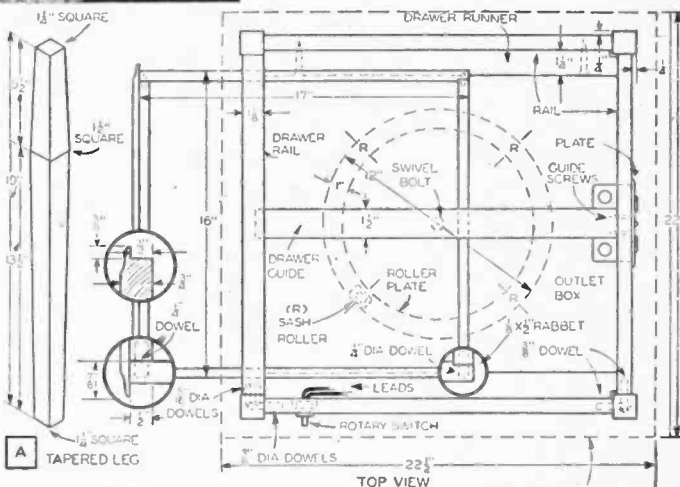

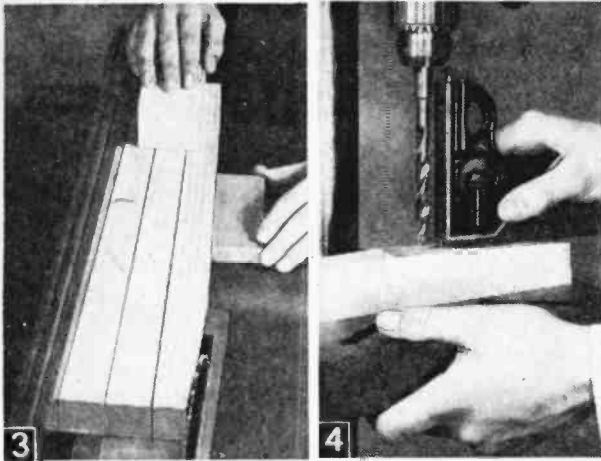

Left, when cutting the short tapers, the narrow parts of the legs face towards the operator. Note push block used to advance all three legs forward simultaneously.

Right, dowel holes in the legs should be bored at true right angles to the face side of the short tapers, using a spur bit for making the holes.

dimensions are reached on the lower end of the legs. The short tapers (at the upper end of the legs) are made on two adjacent sides only, which in this instance are best cut on a circular saw (Fig. 3). Position your fence $4\frac{1}{2}$ in. from an inside tooth and sandwich two of the previously tapered legs between the fence and the leg to be short-tapered. After this taper is cut, turn the leg over to make a similar taper on an adjacent side. Then repeat the process with the other three legs.

Next, form the sides, back and drawer rails, and then cut a rectangular opening in the back rail for an outlet box, and an inside mortise in the right rail towards the front for insertion of the light-control switch (Fig. 2). Dowel holes are bored in the rails first and then spotted (preferably with dowel centers) on the short tapered sections of the legs. If these matching holes in the legs are made on a drill press, tilt the table slightly to the left, to square

up the tapered surface with the bit (Fig. 4). To assemble these parts, first join the drawer rails and front legs together with dowels and a liquid hide glue to form a unit, then join the rear legs to the back rail. Then dowel and glue these two

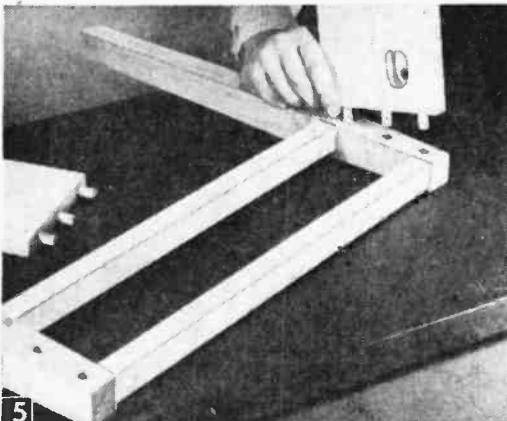

Assembling right rail to front leg unit. Note mortise and thru-hole for mounting lamp control switch.

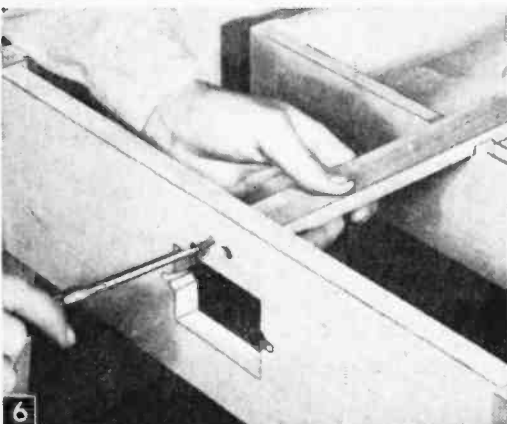

Drawer guide is attached with screws to the rear and top front drawer rail. Note notch cut in the drawer back for the guide.

MATERIALS LIST—TELEVISION STAND

| No. Pcs. | Description | T (in inches) | W (in inches) | L (in inches) |
|----------|-------------------------|------------------|------------------|------------------|
| 4 | Legs | $1\frac{5}{8}$ | $1\frac{5}{8}$ | 19 |
| 2 | Drawer rails | $\frac{3}{4}$ | $1\frac{1}{8}$ | $17\frac{1}{2}$ |
| 2 | Fillers | $\frac{3}{4}$ | $1\frac{1}{8}$ | $3\frac{1}{2}$ |
| 2 | Side rails | $\frac{3}{4}$ | 5 | 18 |
| 1 | Rear rail | $\frac{3}{4}$ | 5 | $17\frac{1}{2}$ |
| 1 | Drawer front | $\frac{3}{4}$ | $4\frac{1}{4}$ | $16\frac{3}{4}$ |
| 2 | Drawer sides | $\frac{1}{2}$ | $3\frac{1}{2}$ | 17 |
| 1 | Drawer back | $\frac{1}{2}$ | $3\frac{1}{2}$ | $15\frac{1}{4}$ |
| 1 | Drawer bottom (plywood) | $\frac{3}{4}$ | $15\frac{1}{2}$ | $16\frac{1}{2}$ |
| 2 | Drawer slides | $\frac{3}{4}$ | $1\frac{1}{4}$ | $18\frac{1}{4}$ |
| 1 | Drawer guide | $\frac{1}{2}$ | $1\frac{1}{2}$ | $18\frac{3}{4}$ |
| 1 | Sub top (plywood) | $\frac{3}{4}$ | 20 | $20\frac{1}{2}$ |
| 1 | Swivel top (plywood) | $\frac{3}{4}$ | 22 | $22\frac{1}{2}$ |
| 1 | Roller plate (Preswood) | $\frac{1}{8}$ | $12\frac{1}{8}$ | $12\frac{1}{8}$ |

MISCELLANEOUS ITEMS

| | | | | |
|----|-------------------------------------|---------------------|--|----------------|
| 4 | Sash rollers (see drawing) | | | |
| 1 | Carriage bolt | $\frac{5}{16}$ dia. | | $2\frac{1}{2}$ |
| 2 | Lock nuts and 1 washer | | | |
| 6 | Dowels (for drawer rails) | $\frac{5}{16}$ dia. | | $1\frac{1}{2}$ |
| 18 | Dowels (for side and back rails) | $\frac{3}{8}$ dia. | | $1\frac{3}{4}$ |
| 12 | Dowels (for drawer assembly) | $\frac{1}{4}$ dia. | | 1 |
| 2 | Drawer pulls | | | |
| 4 | Casters (swivel type) | | | |
| 12 | Misc. flathead screws (see drawing) | | | |

ELECTRICAL PARTS

| | |
|---|--------------------------------------|
| 1 | Outlet box |
| 2 | Outlet box connectors |
| 2 | Convenience outlets |
| 1 | Convenience outlet plate (duplex) |
| 1 | 12 ft. Appliance cord (14 gage) |
| 1 | Appliance plug (male) |
| 1 | Socket (keyless) |
| 1 | Tubular half shade |
| 1 | Mounting bracket (metal) see drawing |
| 1 | Tubular lamp (40 watt, T 10) |
| 1 | Rotary switch |

Note: Dimensions given are finished sizes. Parts are cut from solid stock unless otherwise specified.

units to the side rails (Fig. 5). Anchor the fillers in the drawer opening to the front legs with nails. For the drawer, make the necessary rabbeting cuts for the corners, grooves for the bottom, and then fashion the lip on the drawer front (Fig. 2). Then assemble the parts by first joining the front and back to one of the sides, and then inserting the bottom in the grooves and adding the remaining side. Next, fit the runners and install the guide as in Fig. 6.

Fig. 2C shows the type of sash roller on which the revolving top rides. These rollers are installed in mortises cut in the sub top (Fig. 7), and the sub top is screwed to the legs. Next in order is the revolving top to which the roller plate (Fig. 8) is attached with brads. You mount this top on the sub top with a carriage bolt inserted through the pivot holes of these two members (Fig. 2C). Remember to oil the rollers and apply a thin coating of lubricating grease to the roller plate before using. When installing the casters, make certain the stem holes in the legs are bored on a true vertical (see front view in Fig. 2) or on a 3° angle from the leg center line. Boring them parallel with the center line interferes with the swiveling action of the casters. You can do this boring most easily after you have assembled the

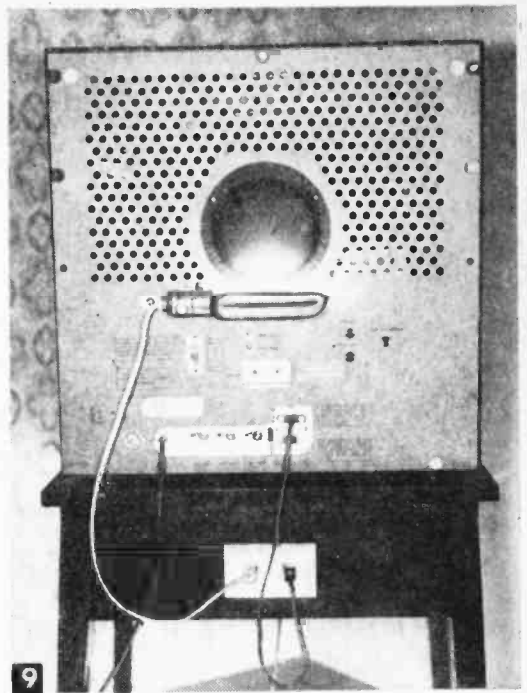

9

Keep wires connecting the lamp and TV set to the receptacles fairly short if you can. With this wiring hook-up it is necessary that only one cord be connected to a wall outlet.

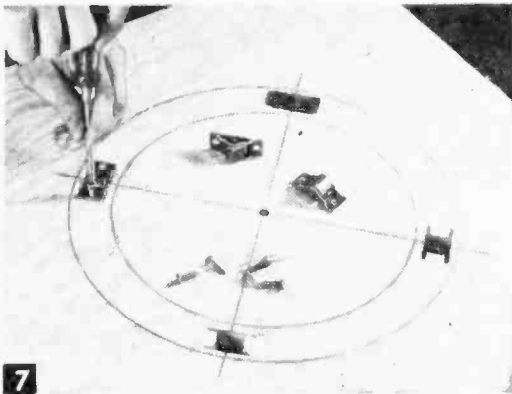

7

Attaching sash rollers diagonally to the sub top.

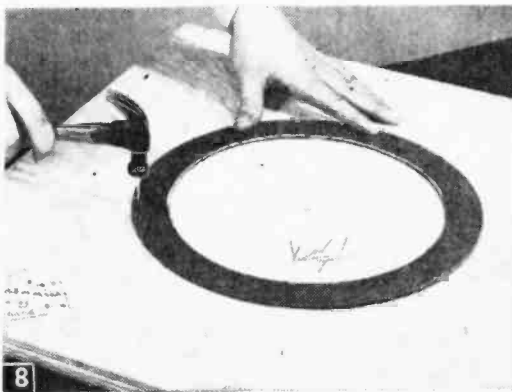

8

When bradring roller plate to the revolving top make certain it is positioned to coincide with the scribed circles shown in Fig. 7.

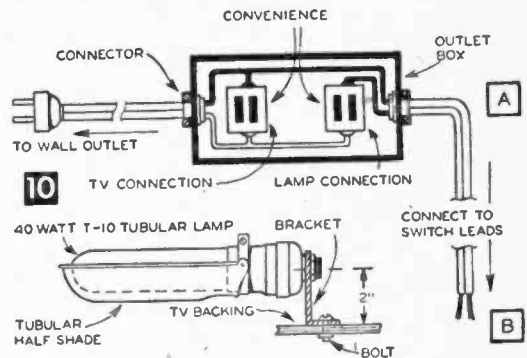

10

parts (minus the revolving top), if it is done on a drill press with the table set at the level position.

After sanding and finishing the wood, you can install the electrical units. The wiring hook-up (Fig. 10A) permits the television set to be operated as usual with its On-Off switch, while the lamp is controlled by a small rotary switch. To minimize eye strain, have the reflected light from the wall match the incident brightness of the picture screen. You can do this by using a 40 watt lamp and half shade (see Fig. 10B) for light walls, 60 watt for medium tones and 75 watt for dark-colored walls. A larger shade or reflector can be substituted for the half shade shown in Fig. 9 to fit the higher wattage lamps.—END

One-Tube Cigar-Box Amplifier

For low-cost convenience or as an extra amplifier for radio or record fans, try building this simply designed unit

BY THOMAS A. BLANCHARD

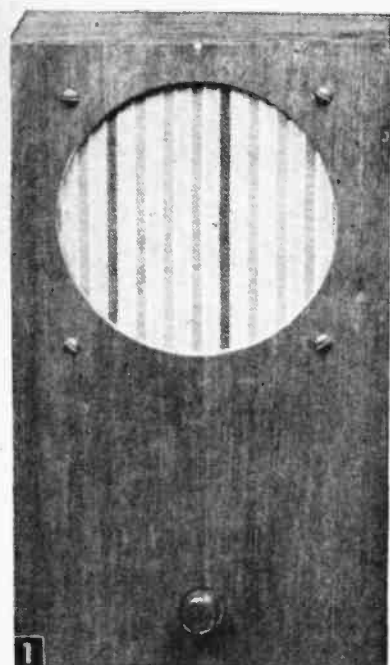

1

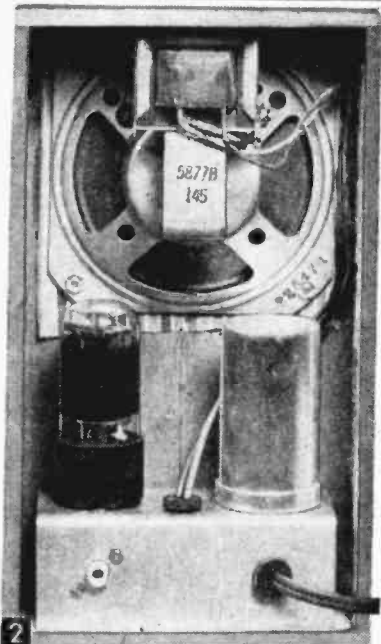

2

Above, utility amplifier built into converted cigar box makes a handy addition to the radio experimenter's work and test bench. Below, mounting 2500-ohm output transformer for PM speaker on speaker frame instead of chassis saves space and leaves amplifier section flexible for connecting to other remote speakers if desired.

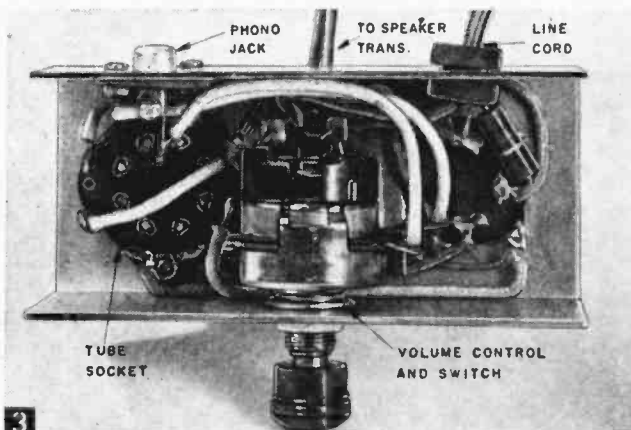

3

Underside of chassis shows the few parts and simple wiring that make this amplifier easy to build.

A SMALL portable amplifier that requires a minimum of parts and time to assemble will be a handy addition to your radio experimenting workbench. You can use this 1-tube circuit for the "innards" of a child's phonograph with a high-output pick-up (2 to 4 volts) or radio tuner.

The simplicity of the circuit is due to the single tube—a 117L7-M7GT that is actually two tubes in one. Half of the tube is a beam power amplifier similar to a 50L6GT. The other half of the tube acts as a half-wave rectifier similar to a 35Z4GT. The tube's two series heaters require no voltage-drop resistor or stepdown transformer, but operate directly off the standard household 110-125-volt ac-dc power line.

The metal chassis is simply a $4\frac{1}{8} \times 3\frac{3}{4}$ -in. piece of 16-gage (.050 in.) aluminum. Lay out and cut the holes with a hole saw or fly-cutter and bend to shape. To keep the number of parts to a minimum, a triple-section electrolytic filter capacitor mounts in one of the large holes. The second hole is for the tube. The two 50-mfd, 150-volt sections of the capacitor are connected into the dc filter circuit; while the third section (20 mfd, 25 volts) bypasses the cathode resistor. All positive capacitor sections terminate at insulated soldering lugs. The capacitor can form a common negative for all three sections (shown as points A, B and C in the illustration, Fig. 5).

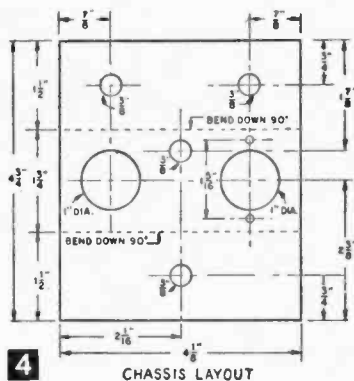

4

CHASSIS LAYOUT

MATERIALS LIST—1-TUBE AMPLIFIER

- 1 pc. #16 gage aluminum (for chassis) 4 7/8 x 4 3/4"
- 1 octal wafer socket; 1 1/16 mtg. centers
- 1 C-O electrolytic capacitor, triple section (50-50 mfd., 150 v., 20 mfd., 25 v.) Type U.P., #5515C. Note: Constructor may substitute 20-20-20; 30-30-20, etc.
- 1 0.5 megohm volume control with switch
- 1 150 ohm, 1/2 watt resistor
- 1 1200 ohm, 1 watt resistor
- 1 phono jack (ICA, RCA) 1 4-in. PM speaker
- 1 output transformer (2500 ohm pri., 3-5 ohm sec.)
- 1 117L7/M7GT tube 1 6-ft. line cord & plug
- 1 Miscellaneous hardware, hook-up wire, rubber grommets
- Suitable pickup cartridges for use with this unit are: Astatic L-72A, L-82A, L-12, L-12U, 15L3-AG and 16L3; or Shure W42N, W56A, or W56N.

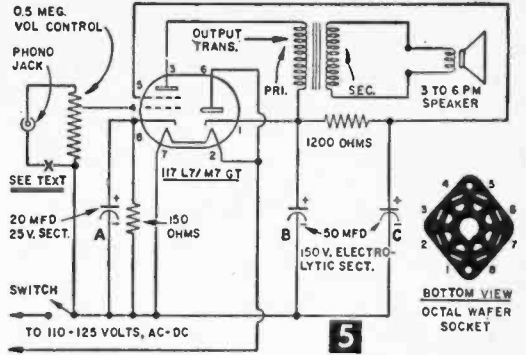

To minimize wiring, the amplifier chassis forms the negative side of the circuit as a ground. While this arrangement leaves the chassis "hot", it is quite safe from shock when mounted in a wood or other non-metallic housing. Shock that might result from handling metal pick-up arm on a record player can be prevented by inserting a .05-mfd 200-volt paper capacitor at (X) in Fig. 5 and mounting the phono jack on a Bakelite disc. However, most modern pick-up arms are plastic. The only chance for a shock from touching chassis is when you're standing on a damp concrete floor or touching some grounded object.

The completed amplifier was so small there was no commercial stock cabinet that would fit. I made the cabinet shown in Fig. 1 from a cigar

box. Remove all the printing or decorative paper with a sanding disc mounted in a portable electric drill. Cut out the 3 5/8-in. hole for speaker with a fly-cutter, coping or keyhole saw. After a fine sanding, apply two coats of white shellac, sanding after each coat is dry with 6/0 garnet paper. Apply paste wax and polish. Cement a disc of cloth to the back side of the speaker hole.

The cigar box cabinet takes a 4-in. PM speaker, but any size up to 12 in. may be used in a suitable baffled box with greater volume and improved tone quality. Since the amplifier is a complete unit, the speaker may be mounted separately from the amplifier. The output transformer for the speaker may be mounted directly

Get This Valuable Book **FREE**



Just for Examining COYNE'S New 6-Volume Set

"Applied Practical Radio-Television"

ON 7 DAY FREE TRIAL!



Yes, you get this big, brand new book, "150 Radio-Television Picture Patterns and Diagrams Explained", absolutely FREE! Just off the press! Gives complete wiring circuits and diagrams on the latest Radio and Television Sets. Easy-to-read, large 8 1/2 x 11" pages, with full instructions on how to read and use the diagrams. A "must" in every Radio and Television service-man's repair kit. You get this valuable book as a FREE Gift for asking to see Coyne's great new 6-book set, "Applied Practical Radio-Television"!

Here's "Know-How" That Makes You Worth More!

Coyne's great new 6-volume set gives you all the answers to servicing problems—quickly! For basic "know-how" that is easy to understand, you'll find everything you want in volumes 1 to 5 which contain over 5000 practical facts and data. They cover every step from principles to installing, servicing, trouble-shooting and aligning all types of radio and TV sets. So up-to-date it includes COLOR TV and UHF, adaptors and converters. Also covers very latest information on TRANSISTORS.

802-Page Television Cyclopedic Included

And then, for speedy on-the-job use, you get volume 6—the famous COYNE TELEVISION CYCLOPEDIA. It answers today's television problems on servicing, alignment, installation and others. In easy-to-find ABC order, cross indexed. Use this 6 volume TV-RADIO LIBRARY free for 7 days; get the valuable Servicing Book ABSOLUTELY FREE!

Educational Book Publishing Division

COYNE

ELECTRICAL SCHOOL

500 S. Paulina St., Dept. 15-RE Chicago 12, Ill.

SEND NO MONEY! Just mail coupon for 6-volume set on 7 days free trial. We'll include book of 150 TV-Radio Patterns & Diagrams. If you keep the set, pay \$2 in 7 days and \$2 per month until \$22.50 plus postage is paid. (Cash price \$20.95). Or you can return the library at our expense in 7 days and owe nothing. **YOU BE THE JUDGE.** Either way, the book of TV-Radio Patterns is yours FREE to keep! Offer is limited. Act NOW!

FREE BOOK—FREE TRIAL COUPON!

COYNE ELECTRICAL SCHOOL, Educational Book Publ. Div., Dept. 15-RE
500 S. Paulina St., Chicago 12, Ill.

YES! Send 6-volume "Applied Practical Radio-Television" for 7 days FREE TRIAL per your offer. Include TV-Radio Patterns & Diagram Book FREE.

Name.....Age.....

Address.....

City.....Zone.....State.....

Where Employed.....

Check here if you want library sent COD. You pay postman \$20.95 plus COD postage on delivery. 7-day money-back guarantee.

on the speaker (brackets are usually provided).

You can mount the amplifier in the cigar box cabinet with the threaded $\frac{3}{8}$ -in. bushing of the 0.5 megohm volume control. Bring out the two

flexible leads from socket lugs #3 and #1 for connecting to primary of speaker transformer. Use rubber grommets on these two flexible leads and the power line into the back of chassis.—END

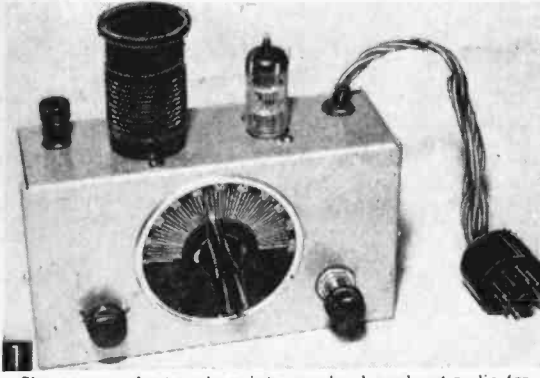

Shortwave adapter plugs into regular broadcast radio for power amplification. An outside antenna, connected to adapter, insures good reception.

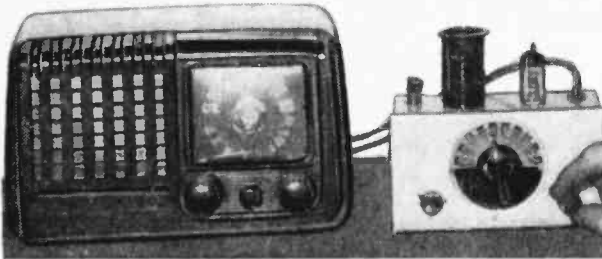

Close-up of adapter fitted with a ready-made coil. Center knob is "band-spread" tuner. Left-hand control is coarse tuner. Regeneration and volume control is at right.

Shortwave Adapter

Eavesdrop on the world, amateur, police and weather stations with this one-tube plugged into your regular AM receiver

UNITED STATES listening!—To England, France, Turkey, Russia, Spain, Canada, Norway, Belgian Congo, French Africa—shortwave broadcasts in English from all over the globe plus your local AM police, fire, weather and aircraft radio. For about the cost of a one-tube radio, you can build this adapter that turns your AM table or console radio into a shortwave receiver. Actually, it is a one-tube regenerative receiver that uses the power supply, amplifier and speaker of your present set. And with this adapter, you don't even have to buy a tube. You just use the detector tube from your present broadcast band set in the adapter.

The adapter is assembled in a $2\frac{1}{8} \times 3\frac{1}{2} \times 6\frac{1}{2}$ -

in. radio box chassis. Blank boxes made of easily drilled aluminum in this or other sizes are sold by all radio parts houses. The pictorial wiring plan (Fig. 4) is arranged to allow for almost any size or shape of box you may select.

Drill three $\frac{3}{8}$ -in. holes in the front of the box for the regeneration-volume control, fine and coarse tuning condensers. Another pair of $\frac{3}{8}$ -in. holes are drilled in the top flap of the box for the cable wire and the insulated antenna binding post. The socket hole for the plug-in socket is $1\frac{1}{8}$ in. diameter and the hole for the detector tube socket is $\frac{5}{8}$ in. if you select a miniature type, or $1\frac{1}{8}$ in. if you select a large metal or glass octal type.

Your choice of the tube socket and cable plug depend upon the radio set you plan to use the adapter with. Fig. 4 shows the adapter wired for sets which use a miniature type tube detector. But if your set happens to employ large tubes, merely substitute the octal socket and

Detector tube removed from radio set and adapter cable plugged into socket. Adapter uses detector tube taken from radios with either large octal-base or mini-plug miniature tubes.

wire according to hook-up designations indicated in Fig. 4A.

Fig. 3 shows the model with a miniature tube working in a set with large GT tubes. If you own two ac-dc sets—one with miniature tubes and the other with large tubes, your adapter may be used with either set simply by changing detector tube plugs. So long as both sets use tubes with the same voltage (indicated by first or first two numbers of tube type, for example 12AT6 uses 12-volt filament voltage) and current characteristics such as the miniature 12AT6 or 12AV6 which are the same as the large 12SQ7GT, either plug or tube socket may be switched around.

Of course, you would normally fit the adapter with a plug and tube socket like that in a particular broadcast set you own. After wiring the adapter, pull out the radio detector tube (see Fig. 4B for typical numbers) and insert it into adapter socket. Then plug your adapter cable into the vacated radio socket. Select a plug-in coil for the shortwave band you wish to listen to, attach a suitable antenna (see below) and tune in!

Turn the regeneration control until a rushing sound is heard. Then retard the control slightly until a distinct "pop" sound is heard. With plates of fine tuner fully open, slowly rotate the coarse tuner until a station is heard. Now by using the fine (main) tuning control, you will find that instead of one station, there are several stations which are easily separated by the band-spread effect of the 15-mmf tuner.

The coarse tuner is fitted with a small pointer knob. As soon as you locate signal spots during its rotation, mark each on the chassis box with a tiny drop of red nail polish. Thereafter, preset the coarse tuner to one of these band spots, and do your actual station hunting with the large tuning knob.

In changing from one band to another, it may be necessary to adjust the antenna coupling in order to obtain regeneration as follows: A $\frac{3}{8}$ -in.

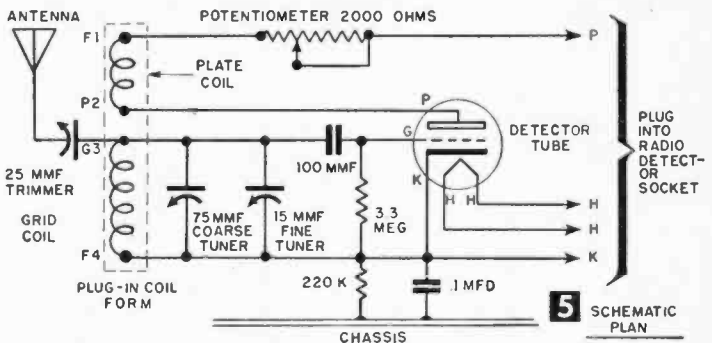
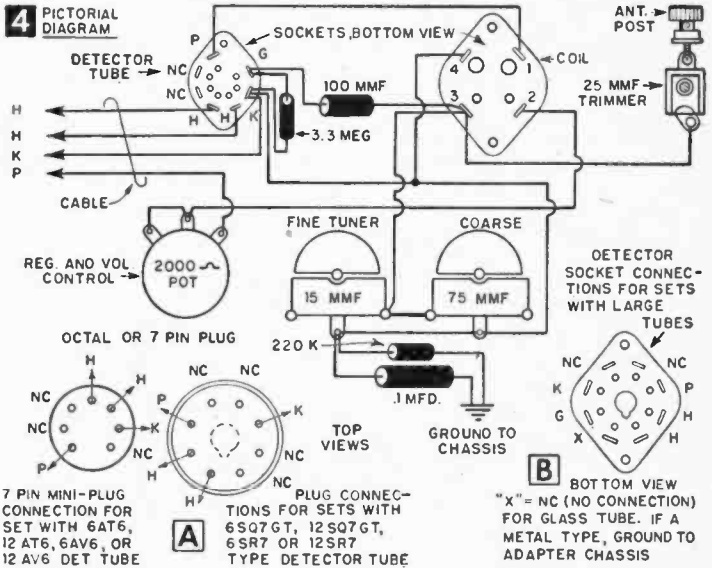
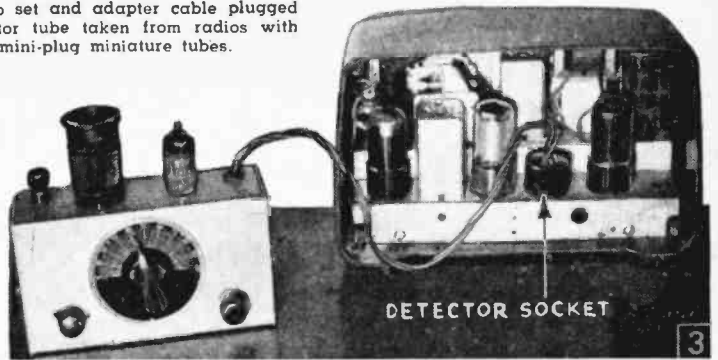

dia. hole, drilled in the back of the box, allows you to adjust the 25 mmf trimmer screw with a screwdriver fashioned from a wood dowel or a plastic knitting needle. Never use a metal blade! To adjust trimmer, first advance 2000-ohm regeneration control so a maximum rushing sound is heard. Now loosen trimmer screw until noise stops. Last, close trimmer screw just enough to start rushing sound again. Retard regeneration control as required for clear re-

Bottom of adapter with cover off. Cable shown is fitted with octal plug for connecting to a set with large GT or metal tubes. For sets with miniature tubes, merely change plug to a 7-pin mini-plug.

ception on that wave band.

In order to get the knack of shortwave tuning, you will need both the #2 and #3 coils. The #3 coil includes the popular 75-meter amateur phone band. Tuning in local hams will provide you with strong signals and a chance to become familiar with tuning and regeneration adjustments before trying your hand at world-wide reception obtained with the #2 coil.

Best shortwave reception on 25 to 49 meters is obtained between 4 and 8 P. M., EST for European stations. Best reception from Australia and the Far East comes in between 6 and 10 A. M., EST. Shortwave reception below 50 meters is subject to atmospheric conditions. You may find reception varies from excellent to poor—good today; bad tomorrow, next week or next month.

During periods of poor atmospheric conditions, you can explore ham, commercial and municipal broadcasts with the 49-105- and 105-200-meter coils. For good shortwave reception, hook up a 50 to 75-ft outdoor antenna to the adapter's antenna post. In some areas 25 ft of wire placed around the room or under a rug works well. Actually, we logged stations by using the 12 ft of aluminum linoleum trim on our workbench. A small battery clip established contact with adapter.

To prevent detuning caused by body capacitance, the adapter chassis is grounded through a .1 mfd capacitor and 220K resistor. If your

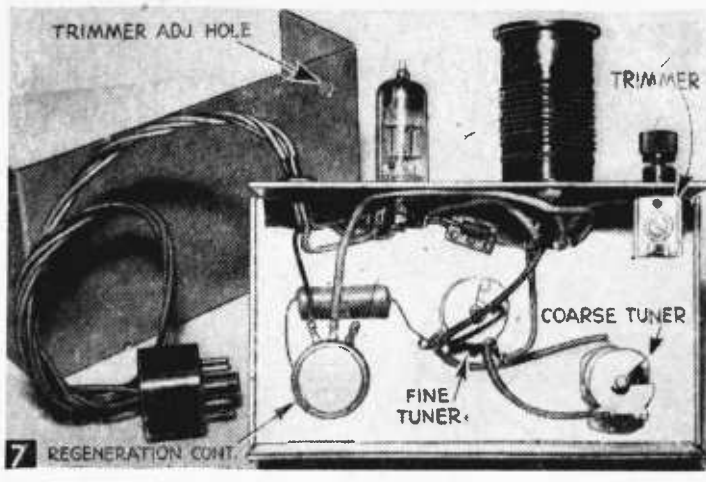

MATERIALS LIST—SHORTWAVE ADAPTER

- 1 LMB or ICA box chassis (original model 2½ x 3½ x 6½ in.)
- 4 UX tube bases, commercial 4-pin coil forms, or ready-made shortwave coils
- 1 small spool #24 DCC (double cotton covered) coil wire, # 28 enamelled wire if coil #4 is desired
- 1 7-pin mini-tube socket, or octal tube socket
- 1 UX (4 pin) Amphenol "MIP" socket
- 1 7-pin Na-ald miniature cable plug, or Amphenol octal plug "CP" type (radio tube base may be substituted for the latter)
- 1 antenna binding post with insulating washers
- 1 3.3-megohm, ½-watt insulated resistor
- 1 220K (220,000)-ohm, ½-watt resistor
- 1 Mallory Midgetrol potentiometer; 2000 ohms with #4 linear taper (#U-6)
- 1 midget variable capacitor, 15 mmf max.
- 1 midget variable capacitor, 75 mmf max.
- 1 100 mmf mica or ceramic trimmer capacitor, 25 mmf
- 1 100 mmf mica or ceramic fixed capacitor
- 1 .1 mfd paper capacitor, 400 w.v.
- hook-up wire, solder, 2 small knurled knobs, 1 bar pointer knob, ¾-in. rubber grommet, Duco or GC cement for securing coil windings to form. Dialplate is a Crowe #552.

Values may be slightly higher if exact sizes not readily available

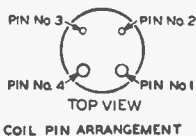
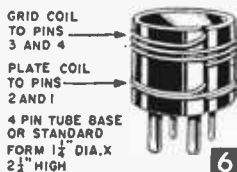

| | Frequency Range | Grid Coil Turns | Plate Coil Turns | Wire |
|---------|---------------------------|-----------------|------------------|-----------|
| Coil #1 | 15-25 meters (20-12 mc) | 5 | 4 | 24 DCC |
| Coil #2 | 25-49 meters (12-6 mc) | 12 | 5 | 24 DCC |
| Coil #3 | 49-105 meters (6-3 mc) | 24 | 10 | 24 DCC |
| Coil #4 | 105-200 meters (3-1.5 mc) | 50 | 15 | 28 enamel |

Allow ½-in. spacing between coils. Be sure Grid and Plate coils are wound in same direction and connected to coil form pins shown above or adapter will not work.

set employs 6-volt tubes (6AV6 for example) the rotor lug of fine tuner may be grounded directly to chassis with a short piece of hook-up wire. However, all sets with 12-volt tubes are ac-dc hook-ups and ground return of set is "hot."

For ac-dc sets, capacitor-resistor chassis ground must be used to prevent shock. Also, test adapter with set line plug's prongs reversed in outlet as unit works best when set's ground circuit connects to ground side of power line. No separate ground connection is made to adapter as this is automatically established when power cord is plugged in correctly.—END

Cutting Screws to Length

• Instead of keeping a shelf full of machine screws in different lengths, particularly in the small sizes, try keeping only medium and long lengths in each size and cutting screws to desired length in a lathe. Chuck the unwanted portion of the screw in your lathe's 3-jaw chuck with the head out, leaving about ½ in. more than the required length of the finished screw projecting. With a fine slitting or knife file, cut the exposed screw with the chuck rotating at slow speed. Screws cut off this way will start just as readily as an uncut screw.—T. L. S.

Combination Bed Lamp and Crystal Set

By ARTHUR TRAUFFER

WHEN attached to the headboard of your bed (Fig. 1), this combination unit lets you listen to local stations while you read in bed. Since ear-phones are used, you can listen late in the evening without disturbing others (a feature which makes this unit ideal for use in hospitals). The crystal receiver requires no conventional antenna and ground; the same power-cord that feeds the lamp also serves as an effective antenna. Since one side of the power-cord is capacitively and/or inductively coupled to the receiver, the current



The adjustable reflector of the bed lamp crystal set, enables you to throw extra light on your magazine without tilting the lamp.

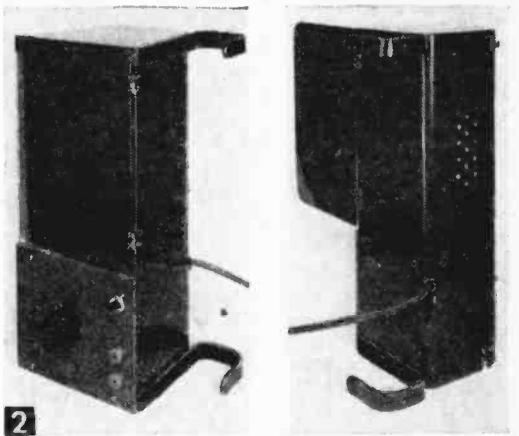

Left, Reflector folds flat against bottom of unit, for transportation purposes or when lamp is not in use. Right, back-view of completed unit.

MATERIALS LIST—COMBINATION BED LAMP AND CRYSTAL SET

- 1 1/2 x 6 x 12" hardwood (ends, partition)
- 1 .024 x 12 x 15" sheet aluminum (housing)
- 1 1/16 x 1/2 x 22" strap brass (hangers, L-bracket)
- 1 2-piece porcelain lamp socket
- 1 rotary canopy switch with pigtail leads, for 117-volt a-c
- 1 2-tie Bakelite terminal strip
- 1 POSJ line-cord with plug
- 1 1/4" I. D. rubber grommet to pass line-cord
- 2 1/2"-square brass cabinet hinges, with 8 rivets or rh screws to fit holes
- 1 1/16 x 1 x 8" felt
- 3 doz. rh wood-screws, 1/4" to 3/4" long (see text)
- 1 1/8 x 5 x 5" piece Masonite hardboard (crystal set panel)
- 1 midgest single-gang variable capacitor, 11.2 to 381.4 mmf (Allied Radio #61-009)
- 1 hardwood tool handle 1 3/8" dia. x 5" long, for coil form
- 1 Sylvania 1N34 crystal germanium diode (or General Electric 1N51, or Raytheon CK705)
- 2 phone tip jacks
- 1 mica 500-volt fixed capacitor, .001 mfd or smaller
- 1 tuning knob with pointer for 1/4" shaft (setscrew type)
- 8 small lock-washers
- 3 soldering tugs
- 7 6-32 x 1/4" rh machine screws 1/4" long
- 2 6-32 nuts
- 1 pr. good quality earphones, 2,000-ohms or more
- hook-up wire, shellac, heat-resisting aluminum paint, heat-resisting enamel, 100 ft. Belden #28 Cotenamel copper wire, 3/8" rh wood screws, Duco cement, ring-nut to fit shank of switch

in the power-lines is blocked, and there is no danger of shock to the listener. The receiver draws no current, but works only when the power-cord is plugged in. The lamp bulb has its own switch.

Build the lamp housing first. Draw the pattern (Fig. 3) for the ends and the partition on 1/2-in. squared paper, then trace on hardwood a full 1/2 in. thick, and jigsaw out. If you have a bandsaw, you can get all three pieces exactly alike by stacking three squares of wood, nailing them together so they won't slip, and then tracing

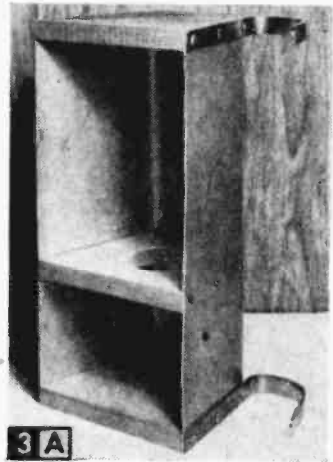
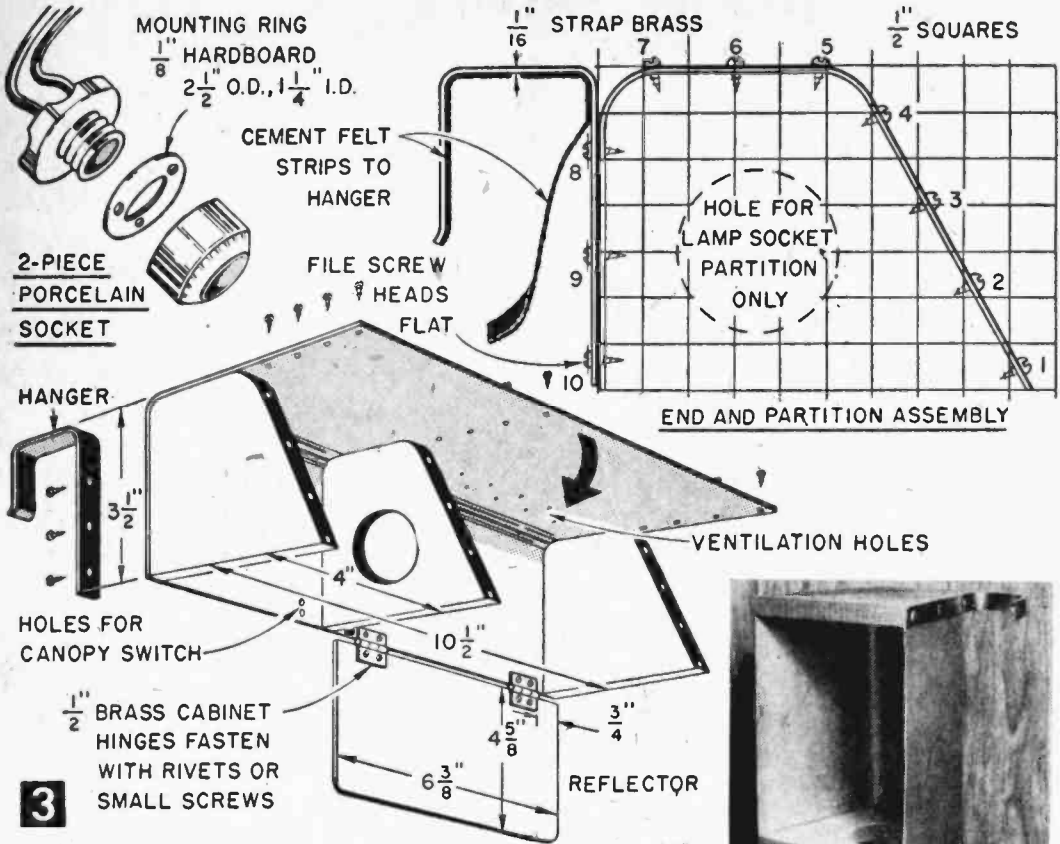

The housing with partition and hangers installed. The reflector has not yet been added.

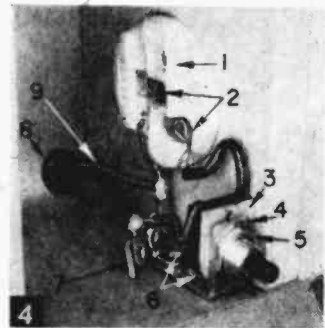

Lamp and Switch Details

1. Socket
2. Soldering lugs
3. Canopy switch
4. Hexagon nut
5. L-bracket
6. $6-32 \times \frac{1}{4}$ " rh machine screws
7. Terminal strip
8. $\frac{1}{8}$ " I.D. grommet
9. Line cord

the pattern on the top piece. Sand all edges and sides. In the partition piece, cut an opening to make a snug fit with the socket you use, as socket will be cemented or clamped into the hole.

Next, cut a piece exactly $9\frac{3}{16} \times 10\frac{1}{2}$ in. from .024-in. (or slightly heavier) sheet aluminum. Bore for the rh wood-screws, spaced as shown in Fig. 3. Give both sides of the metal a satin finish by rubbing hard with a kitchen scouring powder and a damp rag. Then, wash off all traces of the scouring powder with hot water. This satin finish provides a good painting surface on the aluminum. Form the sheet metal around the edges of the wooden end pieces by starting at the front and fastening with inserting wood screws as the forming progresses in the order indicated by the numbers (Fig. 3). Screws 1 to 7 can be $\frac{1}{4}$ in. to $\frac{1}{2}$ in. long, depending on the hardness of the wood, while screws 8, 9, and 10, can be $\frac{1}{2}$ in. to $\frac{3}{4}$ in. long. If sheet metal overlaps at back, file off the excess.

Bend the two hangers from $\frac{1}{2} \times \frac{1}{2}$ -in. strap brass (Fig. 3), in size and shape to fit the bed you want to use the lamp on. Bore three holes in each hanger to line up with screws 8, 9, and 10, remove screws, and fasten the hangers to the back of the housing at the end pieces (Fig. 3-A).

Now, looking at the lamp housing from the front, measure $3\frac{3}{4}$ in. from the left end and draw a line around the housing. Lay out equal spacing along line for ten rh wood-screws, bore holes and fasten partition to housing (Fig. 3). For a finished appearance file all 30 of the screw heads flat to look like rivets, then round off the sharp edges with fine sandpaper.

Rub both sides of the $.024 \times 4\frac{5}{8} \times 6\frac{3}{8}$ -in. piece of sheet aluminum for reflector (Fig. 3), with scouring powder and fasten to the back of the lamp housing with two $\frac{1}{2}$ -in. brass cabinet hinges. Fasten the hinges to the reflector with rivets and to the housing with small

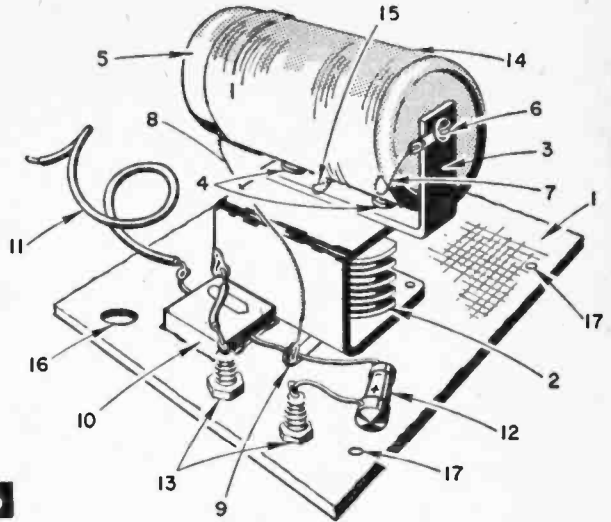
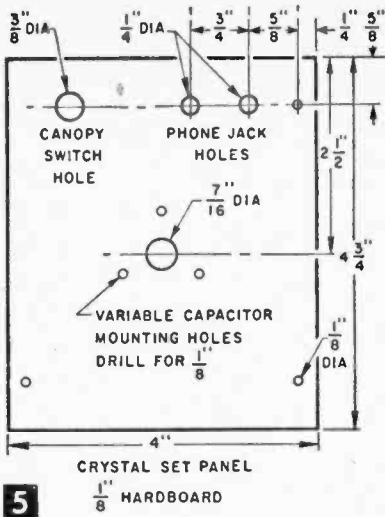

Crystal Set Details

- | | |
|-----------------------------------------------------|-------------------------------|
| 1. Composition board | 10. Mica fixed capacitor |
| 2. Variable capacitor | 11. Flexible insulated lead |
| 3. L-bracket | 12. Germanium diode (crystal) |
| 4. 6-32 x 1/4" rh machine screws | 13. Earphone tip jacks |
| 5. Wood coil form | 14. Tuning coil |
| 6. 3/4" steel rh wood screw | 15. Tap on tuning coil |
| 7. Ground lead of tuning coil | 16. Opening for switch shank |
| 8. Hot or grid lead | 17. Panel mounting holes |
| 9. Stator lug on bottom of variable capacitor frame | |

rh machine-screws; this makes it easy to remove the reflector if you should wish to do so later. You can mount the hinges on either side of the metal, but be sure you mount them so that the reflector can be folded flat against bottom of lamp housing.

Next, cleanse all dirt and grease from all the metal with turpentine or benzine. Give the light-reflecting surfaces of the housing and reflector a smooth coat of aluminum paint; this makes a better reflecting surface than the bare aluminum. Give the entire outside of the housing, the back of the reflector, and the outside surfaces of the hangers, a coat of enamel. Two of the most popular colors for bed lamps are brown and ivory. Give the wood surfaces inside the radio compartment of the housing two coats of shellac.

Cement a 1/2-in. wide strip of felt to the inner surfaces of each hanger, using *Duco* cement (Fig. 3). Be careful not to get any cement on the enamel, as it will remove the paint. Drill ventilating holes for bulb with a 1/16-in. drill and countersink slightly on both sides (Figs. 2 and 9).

For the lamp bulb, fasten a soldering lug under the head of each terminal on the back of the porcelain socket, (Fig. 4) and cement the socket into the hole in the wood partition piece using *Duco* cement or, better still, make a mounting ring (Fig. 3). To avoid crowding, don't let the back of the socket project very far into the radio compartment of the housing. Bend a 1 x 1 1/2-in. L-bracket from 1/16 x 1/2-in. strap brass. Bore two 1/8-in. holes, about 1/2 in. apart, in the long side of the L-bracket. Bore a 3/8-in. hole in the short side of the L-bracket, and fasten the canopy switch into this hole, using a single hexagon nut (#5, Fig. 4). Now drill two 1/8-in. holes in the back of the housing for mounting bracket and switch (Figs. 3 and 4).

Place the bracket and switch unit so that enough of the threaded shank on the switch will project through the hole in the 1/8-in. thick Masonite hardboard panel to enable you to screw

a ring-nut onto the shank, from outside of panel, thus holding one corner of the panel securely. Mount the 2-tie terminal strip under the nut of the upper or rear machine-screw (#6, Fig. 4). Use lock-washers under the nuts of both screws. In the top of the lamp housing, near the back, bore a 3/8-in. hole and insert the rubber grommet. Pass the line-cord through the grommet into the radio compartment, and wire the socket, switch, and line-cord in series, soldering all connections, as shown. Give all the exposed lugs and terminals a couple of coats of shellac, varnish, or clear lacquer, to reduce the possibility of shorts when crystal set is inserted into the compartment.

The crystal set panel (Fig. 5) consists of a 4 x 4 3/4-in. piece of 1/8-in. Masonite hardboard or other composition board. For the exact location of the variable capacitor holes, make a template from the front of the capacitor frame, and mark off on panel.

Mount the variable capacitor onto the panel with three 6-32 rh machine-screws 1/4-in. long, and then mount the two phone tip jacks onto the panel (Fig. 6). Cut the 2 1/4-in. wooden coil form from a 1 3/8-in. dia. hardwood tool handle, give it a coat of shellac, and set aside to dry. There are two pairs of holes on the back of the variable capacitor frame; thread the bottom pair, which are about 1 1/10-in. apart, with a 6-32 tap for the L-bracket mounting screws. Bend the 1 1/4 x 1 3/4-in. L-bracket from 1/10 x 1/2-in. strap brass. Drill two 1/8-in. holes in the long side of the L-bracket to line up with the two holes just threaded, and locate so that the L-bracket will

center the coil form nicely in the radio compartment of the housing. On the short side of the L-bracket, drill a $\frac{1}{8}$ -in. hole about $\frac{1}{4}$ in. from the end; this is for the *rh* steel wood-screw that will hold the coil form to the bracket (#6, Fig. 6). Now mount the L-bracket onto the rear of the capacitor frame, using two 6-32 *rh* machine-screws $\frac{1}{4}$ -in. long, with lock-washers under the heads (#4, Fig. 6).

Now wind the coil. In the circuit used here (Figs. 6 and 7), the number of turns on the coil depend on the size of the fixed capacitor: the smaller the capacity the greater the number of turns required. Experiment for best results, considering your location, broadcast stations, house-lighting system, etc. However, do not use a value any larger than .001 *mfd*. The original set uses a .001 *mfd* fixed capacitor, and 88-turns (closely-spaced) of #28 Belden Cotenamyl on the coil. When winding the final coil, hold the first few turns with coil-dope, then wind approximately 25 turns and twist a small loop for the tap (#15, Figs. 6 and 7), then wind the balance of the turns. Coat the completed winding with coil-dope or shellac to hold the turns fast.

Fasten the coil-and-form to the L-bracket with a *rh* steel wood-screw about $\frac{3}{4}$ -in. long; a lock-nut between the wood form and the bracket keeps the form from turning. Place a soldering lug under the screw head. Ground lead of coil connects to this lug (#7, Fig. 6), while hot lead connects to stator lug (#8, Fig. 6).

Now wire the receiver (Figs. 6 and 7), soldering all the connections securely. Cement the

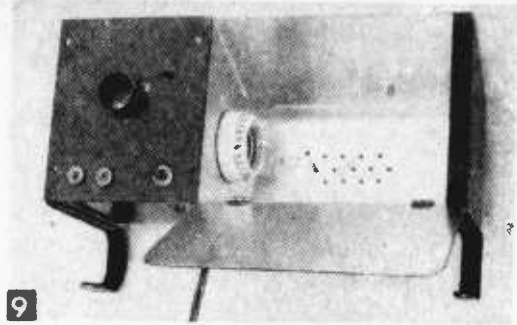

Bottom-view of the completed unit

mica fixed capacitor onto the panel with *Duco*. Connect inner tip jack to frame of variable capacitor (soldering lead directly to the frame as shown in Fig. 6). Connect one lead of diode to outer phone tip-jack, and the other lead to stator lug on bottom of variable capacitor frame. One side of fixed capacitor also connects to stator lug. The flexible insulated lead, about 6-in. long, (#11, Fig. 6), connects one side of the fixed capacitor to one side of the power-cord inside the radio compartment of the housing; connect this lead to the side of the line that is "on" at all times and not affected by the lamp switch. Now insert the crystal set assembly into the radio compartment of the housing, and fasten the panel securely with three *rh* wood-screws about $\frac{5}{8}$ -in. long, and a ring-nut on the threaded shank of the rotary canopy switch. Secure a pointer-knob to the variable capacitor shaft.

Now test the set, making sure that the coil is well-centered inside the compartment, and that there is no short of any kind between the metal parts of the crystal set and the power-cord lugs and terminals. The only connection from the crystal set to the power-line should be through the fixed capacitor. For increased selectivity, disconnect the crystal lead from point Y (Fig. 7) and connect it to tap on the coil; but sensitivity may be somewhat reduced by this change.

Another method of coupling the crystal set coil to the power-lines requires no blocking fixed capacitor (Fig. 8). Simply wind up to 10 turns of insulated, flexible, copper wire directly over the "high-end" of the tuning coil L2. Sensitivity and selectivity will depend on the number of turns of L1: few turns result in increased selectivity and reduced sensitivity, while more turns result in increased sensitivity and reduced selectivity. Experiment for best results. This power-line coupling method will require about 105 turns of #28 Belden Cotenamyl on coil L2. Solder the "high-end" of L1 to one side of the power-cord inside the radio compartment, and tape the free end of L1 with electrical tape. Use one side of a length of POSJ lamp-cord (split apart) for winding L1. The turns of L1 can be held in place with rubber cement, or *Duco* cement, depending on the type of insulation on the wire; or you can wrap a few turns of tape over the winding to hold it.—END

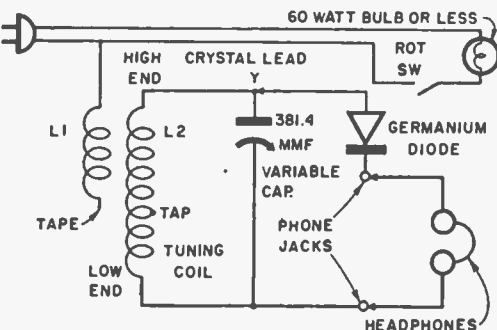
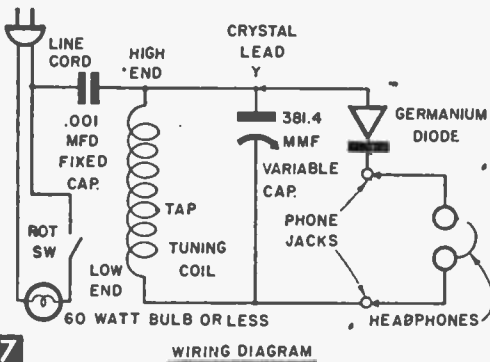

General Purpose AC Amplifier

By HAROLD P. STRAND
Electrical Editor

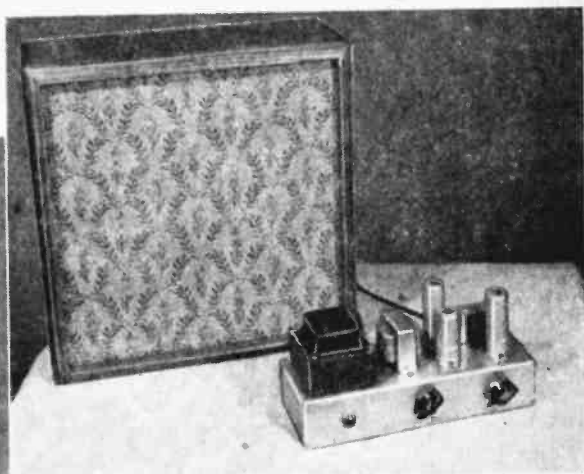
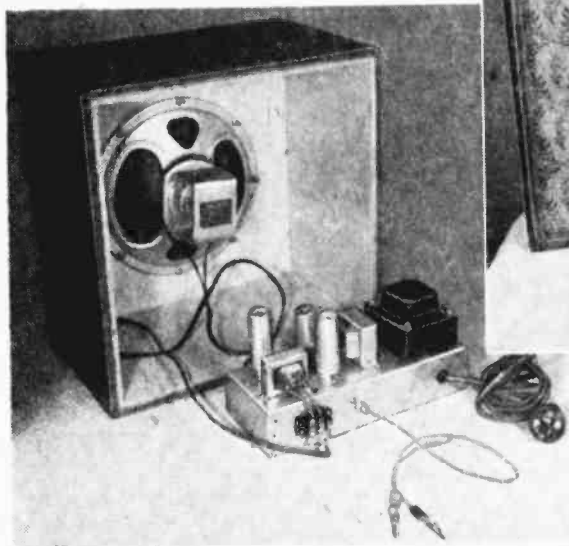

Dwarfed by a large 8 in. permanent magnet speaker unit, this miniature amplifier is capable of outstanding performance, within its 5-watt range.

A rear view of both amplifier and speaker cabinet, showing the connections to the amplifier o line, input and speaker. The 8 in. speaker can be seen mounted on its baffle.

WHILE *ac-dc* radios and amplifiers are used extensively today and perform quite well under most circumstances, there is no comparison in all-around performance with a strictly *a-c*, transformer-operated amplifier. The amplifier described here is built around the newer miniature-type tubes that will provide excellent fidelity with records. A radio tuner or indoor mike can also be used with it when combined with a pre-amplifier and the electrical and radio amateur will find it useful for bench work in experiments and testing. Its output of about 5 watts is ample for the average uses mentioned.

The amplifier consists of a 6AT6 voltage amplifier tube and a 6AQ5 beam power output tube, a Thordarson T22R02 or Stancor P-6119 power transformer, a 16-henry choke, two 16 mfd. electrolytic capacitors (as filters), and a 6X4 rectifier tube. (Materials list shows other components.) The signal is fed into the grid of the 6AT6 voltage amplifier through the volume control, and the plate of this tube is capacitor coupled to the grid of the 6AQ5 power output tube. The output from the 6AQ5 is fed into the output transformer. This tube, while small in size, is rated equally with a 6V6.

The output transformer of any amplifier must match the plate circuit to voice coil of speaker. The Stancor A-3877 used here is rated as single 5000 ohm plate to 4 ohms with maximum power output of 5 watts. This transformer was selected because the impedance of the plate load for a 6AQ5 is specified as 5000 ohms and the usual

MATERIALS LIST—AC AMPLIFIER

| No. Req'd | Description |
|-----------|---------------------------------------------------------------------------------------------------------------------------------------|
| 1 | chassis, made as described in text |
| 1 | Thordarson power transformer, Type T22R02 or Stancor P-6119, 600 V. 50 ma., 6.3 V. 2.7 amp., (5 V. 2 amp. not used) |
| 1 | Stancor output transformer, A-3877, single 5000 ohm plate to 4 ohms, 5 watts or UTC Universal output transformer Type S-14, 10 watts. |
| 1 | filter choke, 16-henry, 55 ma. |
| 3 | 7-pin, miniature shield-base sockets, with shields for tubes listed. $\frac{3}{8}$ " mounting holes |
| 1 | 1 meg. volume control with switch |
| 1 | RCA type phono Jack and plug |
| 1 | 2 terminal Jones strip #140 |
| 1 | $\frac{1}{8}$ " pipe size Bakelite bushing or rubber grommet |
| 10 ft. | $\#18$ rubber parallel lamp cord (longer if required for speaker con.) |
| 1 | attachment plug |
| 3 ft. | $\#22$ shielded wire |
| 1 | 6X4 miniature type rectifier tube |
| 1 | 6AT6 miniature type high- μ triode tube |
| 1 | 6AQ5 miniature type beam power amplifier tube |
| 1 | pilot lamp assembly, $\frac{1}{2}$ " open pilot lamp $\frac{1}{16}$ " mounting hole |
| 1 | 6.3 volt miniature screw base lamp |
| 1 | 50,000 ohm volume control (for tone control) |
| 2 | bar pointer knobs to fit volume control shafts |
| 2 | 16 mfd. 450 volt electrolytic capacitor. |
| 2 | 25 mfd. 50 volt electrolytic capacitor. |
| 1 | .05 mfd. 600 volt paper capacitor |
| 2 | .01 mfd. 600 volt paper capacitor |
| 1 | 560 ohm 2 watts resistor |
| 1 | 2700 ohm 1 watt resistor |
| 1 | 470,000 ohm $\frac{1}{2}$ watt resistor |
| 1 | 100,000 ohm $\frac{1}{2}$ watt resistor |
| 1 | Misc. hook-up wire, bolts, nuts, solder, etc. |
| 1 | permanent magnet speaker, 3-4 ohm voice coil, 8" size |
| 1 pc. | $\frac{3}{8}$ " plywood, $12\frac{1}{2}$ " x $7\frac{1}{4}$ " |
| 4 pcs. | $\frac{1}{4}$ "-round moulding, cut to fit front edge |
| | $\frac{1}{2}$ " Beaver Board to line cabinet and also for speaker baffle. |
| | Grille cloth to suit taste |

at this back side allows connections to the speaker voice coil in a simple manner. At front side of chassis, a pilot lamp assembly is at the left, the volume control in the center and a tone control at the right. The latter is a simple attenuator type of tone control, in the plate circuit of the 6A95. This control regulates the amount of high frequency notes that pass to ground through the condenser. Reducing the resistance reduces the high notes in the output and this tends to accent the bass notes.

The schematic diagram (Fig. 3) should be easy to follow. The tube sockets selected for this job are shield base type, which use tube shields (see photos). These may be eliminated if desired; however, they protect the tubes, hold them tight in their sockets and offer protection from stray fields. To offset their one disadvantage—making the tubes run hotter—shields may be dipped in black lacquer and baked for a short time in an oven. Black absorbs heat from the tubes and radiates it to the atmosphere.

Be sure when wiring the amplifier to follow each connection as shown and solder all terminals and joints. Avoid an excess of solder, which may run down and touch the chassis or ground, causing a short. For best results, observe values of resistors and condensers, together with the transformer and choke; do not substitute other values for these.

In case of an excessive hum, check to see if the 6AT6 grid wiring is near a-c wires, such as line or heater leads. This grid is the most sensitive part of the entire amplifier and care

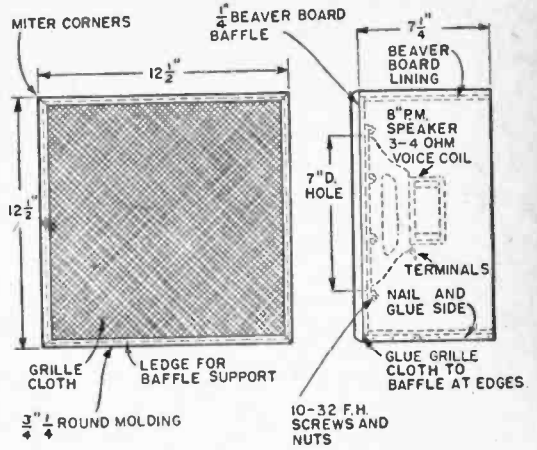

4 FINISH—WALNUT STAIN AND SHELLAC
DETAILS OF SPEAKER CABINET

must be taken to keep all leads as short as possible and shielded. The lead coming from terminal 1 of the 6AT6 must be shielded and the shield grounded. A lead connecting the input jack to the volume control is also shielded, since it is in the grid circuit. This shielded wire is sold in radio stores and its outer metallic sheath is grounded to the chassis by soldering. Do not

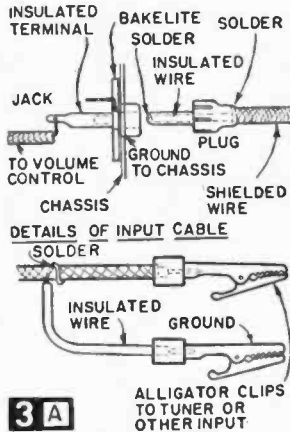

3 A

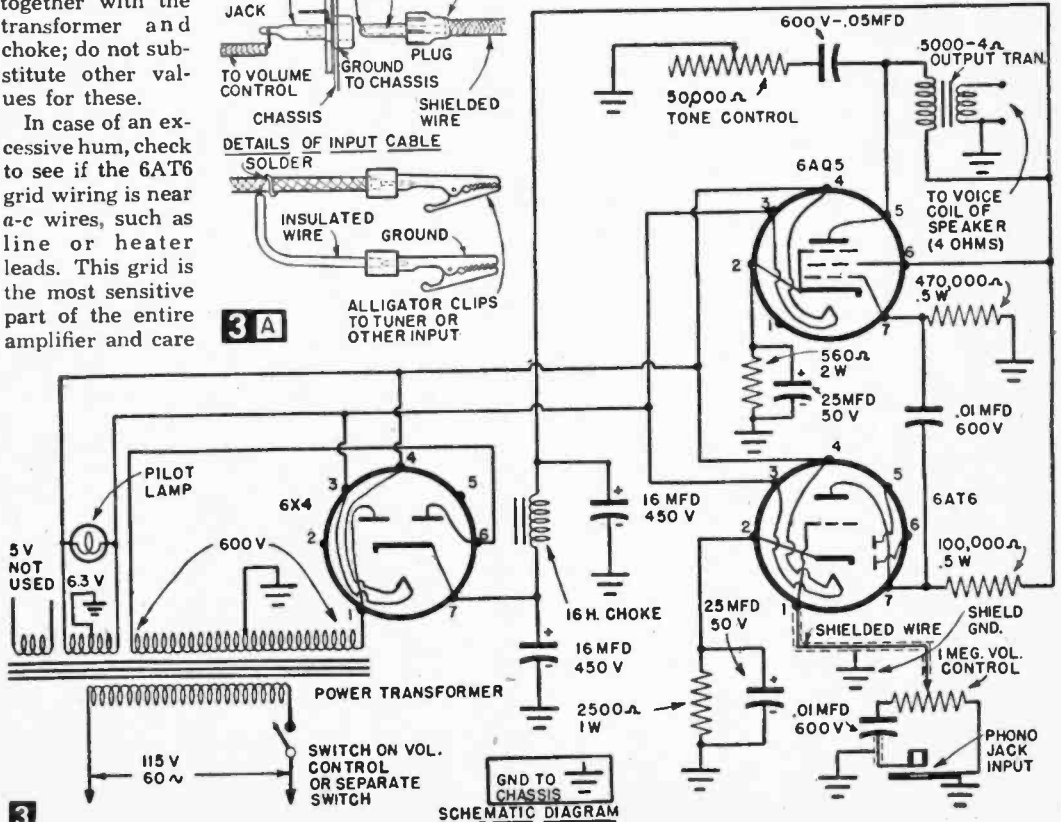

3

SCHEMATIC DIAGRAM

**YOU CAN GET MUSIC RIGHT OUT OF
A BLANK WALL WITH THE**

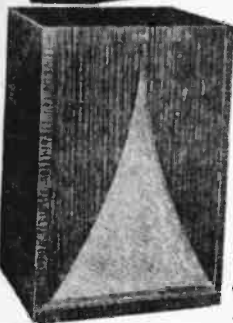

NEW
'KARLSON 12'

Now you can build the world's finest speaker cabinet in a jiffy with the **KARLSON SELF-ASSEMBLING ENCLOSURE KIT**. All you need is a hammer and some glue to assemble the unit, due to the interlocking construction of the dozens of intricately cut pieces.

The "Karlson 12" is the first enclosure ever designed with adjustments to match the speaker used and the liveness of your room.

It has a separate base so it can be used vertically or lying down for "Aural-Optics." Size: 25" x 17" x 14"; Weight 35 lbs.

Self-assembling kit with full **\$37.50**
finishing instructions only

Available finished for **\$99.60**

Send for Booklet "12"

32 Pages Full of Valuable Information

KARLSON ASSOCIATES, INC.

DEPT. S

1483 Coney Island Ave., Brooklyn 30, N. Y.

NOW!

FIX TV FAST!

**No Experience Necessary—
New Book Gives You Easy,
Step-by-Step Instructions**

Get this brand-new, complete handbook for sure-fire how-to-do-it knowledge of TV repair, installation, maintenance and troubleshooting. You'll be amazed how easy it is to fix your own TV set with the help of this manual. And you'll find it equally as easy to make spare-time money fixing TV sets for your neighbors and friends. Perhaps you will want to get a service shop job . . . even start your own full-time business.

You don't need mathematical training to follow the simple, crystal-clear instructions in this book. All possible defects are classified for ready reference, thoroughly analyzed to show what is wrong and why . . . and what to do to correct the fault. You get step-by-step procedures for audio IF alignment, aligning RF amplifiers, mixers, oscillators, etc. . . . how to use the basic tools of . . . how to test tubes . . . how to adjust the ion trap . . . how to install sets and antennas, etc. . . . Contains complete, up-to-date information on color, UHF, transistors.

Mr. C. W. Morris of Charleston, W. Va., Says: "TELEVISION SERVICING is worth many times its cost. I have paid as much as \$200.00 for courses that haven't given me the clear understanding this book has."

Prentice-Hall, Inc., Dept. M-RTE-55
Englewood Cliffs, New Jersey

Send me TELEVISION SERVICING for 10 days FREE TRIAL. Within 10 days I will either return it and owe nothing—or keep it and send \$1.95 down (plus postage) and \$2 monthly for 2 months.

Name

Address

City Zone State

SAVE! Send \$5.95 with this coupon and we'll pay postage & packing.

allow any stray strands of the shielding to touch terminals. This should be back about $\frac{1}{8}$ in. from any terminal.

Another cause of hum is a choke with too little inductance and filter condensers of too low a capacity. In such a case, the a-c ripple is not fully filtered out of the rectified d-c circuit. A 1 meg. $\frac{1}{2}$ watt resistor from the grid of the 6AT6 to ground may reduce the hum, although the 1 meg. volume control serves as the grid resistor.

Make the cabinet for the 8 in. speaker from $\frac{3}{8}$ in. plywood (Fig. 4). Attach speaker to a piece of $\frac{1}{4}$ in. wall board (Beaver Board) as a baffle, using flathead $10\frac{1}{32}$ screws and nuts around the edge of a circular hole. Line inside of cabinet with this same material, after mounting the speaker to greatly improve tone quality. Solder a piece of lamp cord to voice coil terminals of speaker with small terminal clips on the other end, to connect with terminal strip on chassis. This cord can be made as long as desired, so that the speaker can be mounted out of the way on a wall space. A piece of shielded wire must be used for the connection to input jack. Attach plug of jack assembly to one end of this wire, soldering bared end of insulated wire to end of plug tip and soldering the shield to outer end of plug (Fig. 3A). Solder two alligator clips to outer end of wire, one to the insulated wire and the other to a short jumper from a soldered connection to the sheath. This form of input connection is very handy, as the clips can be quickly attached to various tuners and radio components which you may want to put through the amplifier. If the amplifier is to be used as a permanent part of some record player or radio system, the clips can be dispensed with and connections made direct. The direct connection may also reduce hum in some installations. Use of a separate a-c switch also helps to reduce hum.

Clip Holder Keeps Service Manual Open

• Service manual pages or construction prints have a habit of shifting or closing after being opened at the desired page. One method of keep-

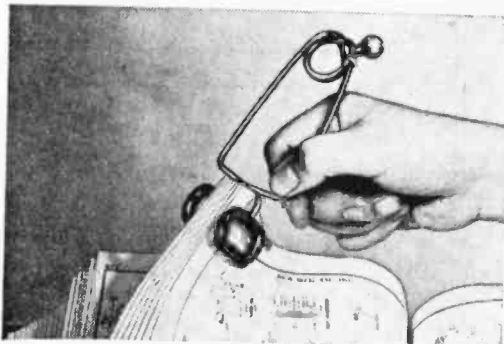

ing such data sheets open where wanted is to use a clip-on holder from a lamp. The clip jaws are rubber covered and, if kept clean, will not damage sheets of book or prints.—H. LEEPER.

Pocket Signal Tracer

You can build this simple crystal diode testing probe for locating circuit breakdowns in radio sets

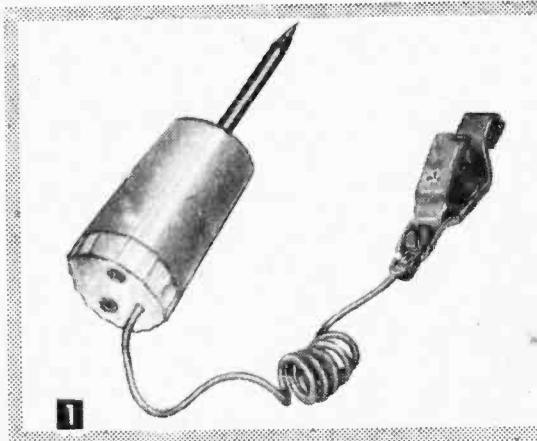

Tracking down the trouble in a radio set by following the signal through the grid and plate of each tube socket. Signal tracer built in a 1x2 in. plastic salt shaker. Alligator clip attaches to the ground or B- circuit of set being checked.

WHEN the simple tests for troubles in a radio set fail, you'll welcome this pocket-size trouble-shooting signal tracer for making a stage-by-stage test to locate the radio's dead section. Operating without any external battery or line voltage, the tracer functions like a crystal radio and is built around a germanium diode. Its small size (this one was built in a salt shaker from a variety store) makes it easy to use. You can also build it into plastic packages for shaving sticks, solid skin lotions or other pharmaceuticals.

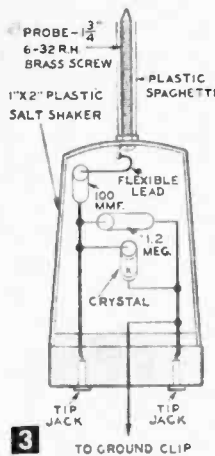

MATERIALS LIST—POCKET SIGNAL TRACER

- 1 Small plastic container (salt shaker, etc.)
- 1 Germanium crystal diode (1N34, 1N34A, 1N60, etc.)
- 2 Metal phone tip jacks (ICA)
- 1 Small battery clip
- 1 100 mmf. mica or ceramic capacitor
- 1 1.2-megohm, 1/2-watt resistor
- 1 1 1/4 x 6-32 RH brass screw and nut, soldering lug, short length radio spaghetti, and 2 ft. flexible hook-up wire.

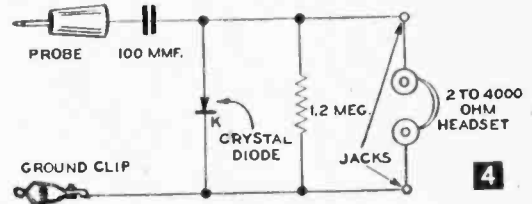

The signal tracer is wired as shown in the pictorial plan (Fig. 3) or schematic diagram (Fig. 4). Drill three holes in the base or cap of the plastic container; two 1/4 in. holes for the phone jacks, and a 1/8 in. hole for the flexible lead to ground (B-) clip. Drill a single hole in the plastic shaker top for mounting the probe.

The probe is an ordinary brass machine screw with a round head (1 1/4 in. long; size 6-32) with the end ground to a point. A short length of flexible insulated wire is secured to a soldering lug. Slip the lug over the screw and mount in

the plastic housing with a 6-32 hex nut. Complete the probe by forcing a 1 1/2 in. length of radio spaghetti over the threads, leaving just the sharp screw tip exposed (Fig. 5).

The pigtail leads furnished with the three components are long enough and rigid to allow direct soldering without use of hook-up wire except for the short flexible probe connection and about 16 in. of flexible lead for the ground clip.

Here's how to use the tracer for tracking down radio set failures when you have completed wiring it. Starting at the radio set's antenna, it will

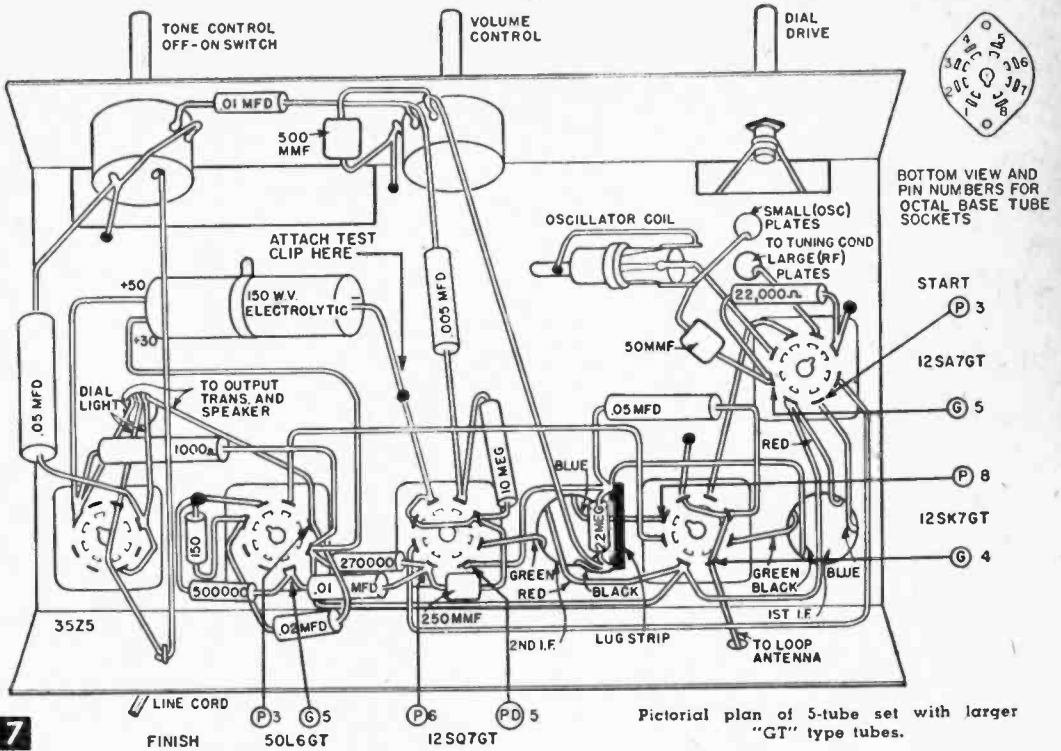

Pictorial plan of 5-tube set with larger "GT" type tubes.

7

tion of the receiver, first find out if the trouble is not simply a *blown* tube. On popular *ac-de* sets, one blown tube extinguishes all tubes. If the tubes light up, tune the set so the dial is on the frequency of a nearby station which came in with the most powerful signal when the set was working. Then, starting with the first R.F. or converter tube if there is no R.F. tube in the circuit, touch the tracer probe to the grid lug of the tube socket. Continue on to the plate of the same tube. Follow through—grid and plate, grid and plate of each tube in set. Assuming tubes are warm and show a visible glow, you will eventually reach a spot where you won't hear a signal.

Suppose you pick up the signal on the *grid* pin of the 12BA6 (or 12SK7GT on a set with *GT* tubes), but nothing when probe is placed on the *plate* lug of same tube socket. The trouble could be due to any of the following: defective tube; open or cold solder joint at cathode, or screen grid, lack of B+ voltage to this tube due to broken lead elsewhere in wiring, open primary winding in I.F. transformer, or defective tube socket.

The signal tracer will not single out the exact component causing set failure. It will, however, localize the source of trouble to a component or connection at the tube where no signal can be picked up off the *grid* or *plate* lug. If, for example, the probe receives a signal off the *plate* lug of the 12AT6 (or 12SQ7GT) detector, but nothing comes through when probe is moved over to *grid* of the 50C5 (or 50L6GT) output tube,

look for an open .01 or .02 *mfd.* coupling capacitor.

At the point where the signal is lost, bad capacitors, resistors, open circuits or combinations of these components will prove to be the culprit. Defective resistors are often apparent on sight by their charred appearance. Bad capacitors are frequently identified by wax leakage on chassis. "Cold" soldered joints are also identified in many instances on sight. If wiggling the suspicious wires restores speaker operation, resolder leads.

Defective components do not necessarily exhibit any outward signs of failure. If loose wires are not the cause of failure, replace the resistors or capacitors in the immediate vicinity of breakdown with components known to be good.

This pocket signal tracer may be used with all types of sets. An inexpensive radio tube basing manual will provide identification of the *grid* (or *diode*) and *plate* socket lugs of sets other than those shown here.

Signal-Booster for Loop

- To increase signal pick-up when a portable receiver is being used in a steel building, connect a regular outdoor antenna to some large insulated metal surface in the room, such as to a copper screen placed under the rug, or to a piece of screen tacked under the table on which the receiver is most often used.

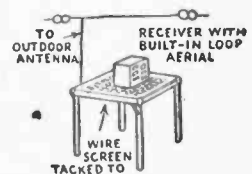

Trapping TV Interference

Much of today's TV interference is caused by overlapping TV stations and local FM stations. This simple trap will often clear up the trouble completely!



The interference pattern shown is caused by a powerful distant station operating on a TV channel adjacent to your local broadcaster.

Interfering channel is tuned out by sliding a plastic handled screwdriver along the bare parallel rods. This Channel 7-13 trap is marked at 1/2-in. intervals.

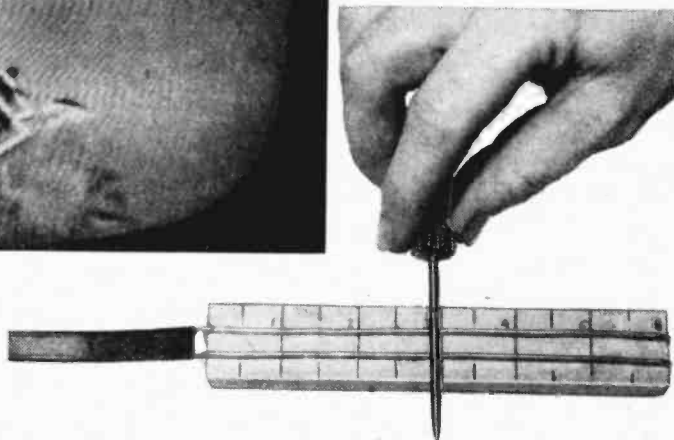

WHILE much of the interference experienced by early owners of TV sets has been corrected, today's set owner is faced with interference on stations which never caused any trouble in the past. This situation is not the fault of amateurs, physicians' diathermy, or industrial electronic devices, except in rare instances. The picture interference many set owners experience today is caused by a powerful TV station operating on a channel adjacent to the one to which you are tuned.

While radio follows the "straight and narrow" path, TV is a "road hog." That is why you will never find two stations in one city on adjacent channels such as 2 and 3 or 12 and 13. Channel 2 would ruin Channel 3, Channel 3 would ruin Channel 4's picture, etc.

There are two exceptions, however. Channel 4 will not affect 5 because there is a commercial band separating the two. Nor will Channel 6 interfere with Channel 7 because a variety of commercial FM operations exist between these frequencies including FM radio, taxi, aircraft, etc.

Connecticut station, in turn, ruins reception of another New York station operating on Channel 9. Conditions such as this exist in nearly every part of the country or probably will in the very near future.

TABLE OF TV INTERFERENCE TRAP LENGTHS

| Interfering TV Channel | Approx Length 300 ohm Lead-In Trap | Eliminates or Reduces Interference on Channel: |
|------------------------|------------------------------------------|------------------------------------------------------|
| 2 | 87 in. | 3 |
| 3 | 79 in. | 4 |
| 4 | No trap required | — |
| 5 | 63 in. | 6 |
| 6 | No trap required | — |
| FM Band | 54 in. or 30 in. | See footnote |
| 7 | 28 in. | 8 |
| 8 | 27 in. | 9 |
| 9 | 26 in. | 10 |
| 10 | 25 in. | 11 |
| 11 | 24 in. | 12 |
| 12 | 23 in. | 13 |
| 13 | No trap required | — |

* Strong local FM radio stations can impair TV reception on various channels. Use 54-in. trap except where interference appears only on Channel 7. Then use 30-in. trap. Short open end of all traps with a 22 ohm resistor for severe interference; 56 ohms for medium, and 150 ohms if weak.

This aggravating situation can be corrected or at least alleviated with simple parallel line tuned circuits at little or no expense to the set owner. In many instances, the interference will disappear completely.

Fig. 1 shows a simple design for two traps covering Channels 2 to 6, and Channels 7 to 13. The latter trap is quite compact, while the trap for the lower frequencies is rather bulky. However, there are ways to reduce the size of the Channel 2 to 6 interference trap.

To make the tuned section of the trap, mount two parallel rods on wires, spaced $\frac{3}{8}$ in. apart, on a strip of wood 6 in. long. Bare copper, aluminum or steel wire about #10 or #12 B&S gage is ideal for the purpose. We used 7-in.

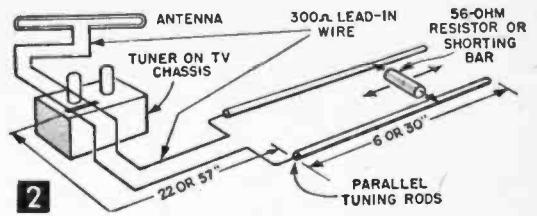

2

wires until all or most of the interference like that shown in photo disappears. Mark the spot on the block and insert a 56 ohm resistor at this point. Any resistor as small as $\frac{1}{4}$ watt may be used. If the interference is acute when shorting bar is replaced by resistor, use a 22 ohm unit. On the other hand, if original interference was of a weak nature, use a 150 ohm value.

The trap will naturally reduce the efficiency of your antenna to some extent on other stations, therefore the higher the resistance value the better. On the other hand, if the resistor is arranged so that it can slide along the tuning bars at will, adjustment can be made for each station as desired. In areas where only one channel causes trouble, the trap may be a continuous length of 300 ohm lead-in wire with a resistor connected across the open end. For example, if the interference of a particular 7-13 channel is trapped with the shorting bar 2 in. from the lead-in end, simply cut a $2\frac{1}{2}$ -in. length of lead-in and strip $\frac{1}{4}$ in. of insulation from each end for attaching resistor and making tuner connections.

For trapping interference between Channels 2 and 6, the tuned lines measure 30 in. This cumbersome length can be reduced to 15 in. by attaching the lines to one side of the wooden strip, bending over the end, and running the leads down the underside in hairpin fashion.

While the variable design is capable of suppressing most adjacent channel interference, further improvement may result when a trap is installed on the rooftop where the TV lead-in connects to the antenna. Having determined the effective length (300 ohm lead, plus ideal shorting point on parallel lines) of the trap, attach resistor and install on rooftop a similar length of TV lead-in wire. Tape to regular lead-in, not to TV mast.

In those rare instances where you get fair reception on the interfering channel, this station will no longer be received. However, if you wish to see its programs, merely disconnect one side of the shorting resistor.

The accompanying table shows the approximate lengths of 300 ohm lead-in wire required to cancel out a particular channel so as to clear the next higher channel of interference. This table is satisfactory between Channels 2 and 6, but lead lengths become critical from Channel 7 down to 13. Thus there is no real substitute for the precise measurement afforded by the shorting bar and block-mounted parallel lines.—END

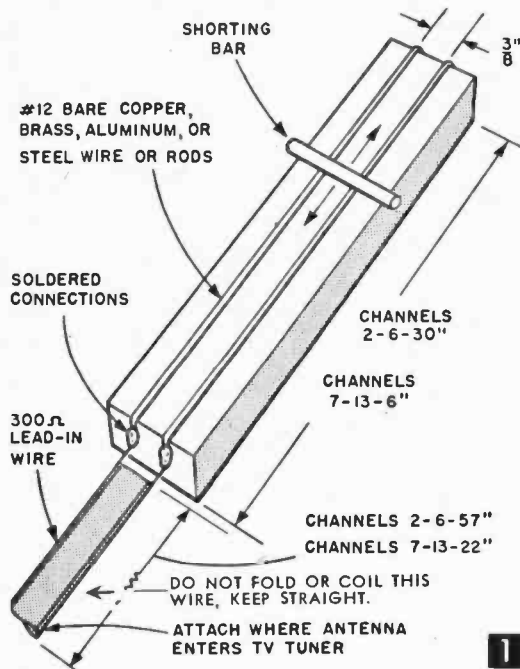

1

lengths of wire, bent over $\frac{1}{2}$ in. at each end and crimped into the wooden strip. The rods may also be secured to the wood with Duco or Pliobond cements so long as they remain rigid.

At one end of the parallel rods, solder a 22-in. length of 300 ohm flat TV lead-in wire. Next, connect the remaining end of the lead-in to the lead-in wire where it enters the tuner of your TV set (Fig. 2). Some TV receivers have as much as 2 feet of wire between the tuner and TV antenna terminals. Do not connect to terminals as this will do little or no good. Scrape off about $\frac{1}{4}$ in. of insulation from each lead of the 300 ohm line. You only need remove enough to allow for a tack-soldered connection of each interference-trap wire to the antenna where it enters the tuner chassis.

Now, assuming the interference is on Channel 8, slide the blade of a plastic handled screwdriver down the parallel block-mounted

Putting 'Electric Eyes' to Work

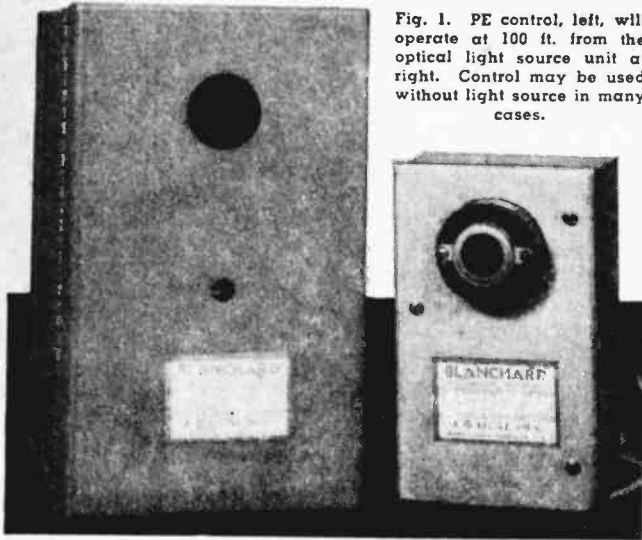

Fig. 1. PE control, left, will operate at 100 ft. from the optical light source unit at right. Control may be used without light source in many cases.

MOST people think of photo-electric controls as burglar alarms or gadgets to automatically open garage doors. While these applications are possible, neither—believe it or not—have ever been very practical. But, there are scores of home and industrial uses for PE (photo-electric) controls where consistent and reliable results can be expected, such applications as fire detectors, store signals and liquid level

or automatic feed controls (Fig. 2).

Units exactly like the control shown here are working day in and day out. In one plant making medical supplies, several controls *exactly* like the one in Fig. 2A have been running 4 years without breakdown. In this instance, the production machines apply small medicated cotton pads and starch-gauze packing at adhesive spaces on a mill roll of adhesive tape. The tape passes along to a die-cutter which stamps out the individual first-aid bandage you find inside the small glassine wrapper.

The problem, prior to installing the PE controls, was to keep the tenacious adhesive tape moving without having to unwind it manually from the mill roll. Pulling the sticky tape free was by far the operator's most difficult task. It also cut production way down. Production was doubled when photo-electric controls were installed. A flat wooden pulley covered with abrasive cloth was placed just ahead of the mill roll of adhesive tape. The pulley was driven by a 1/4 hp motor which in turn, operated off the PE control.

Enough space on the machine was left between the abrasive pulley and the pad applicator for mounting the PE control and light source shown in Fig. 2A. When the machine was started, light

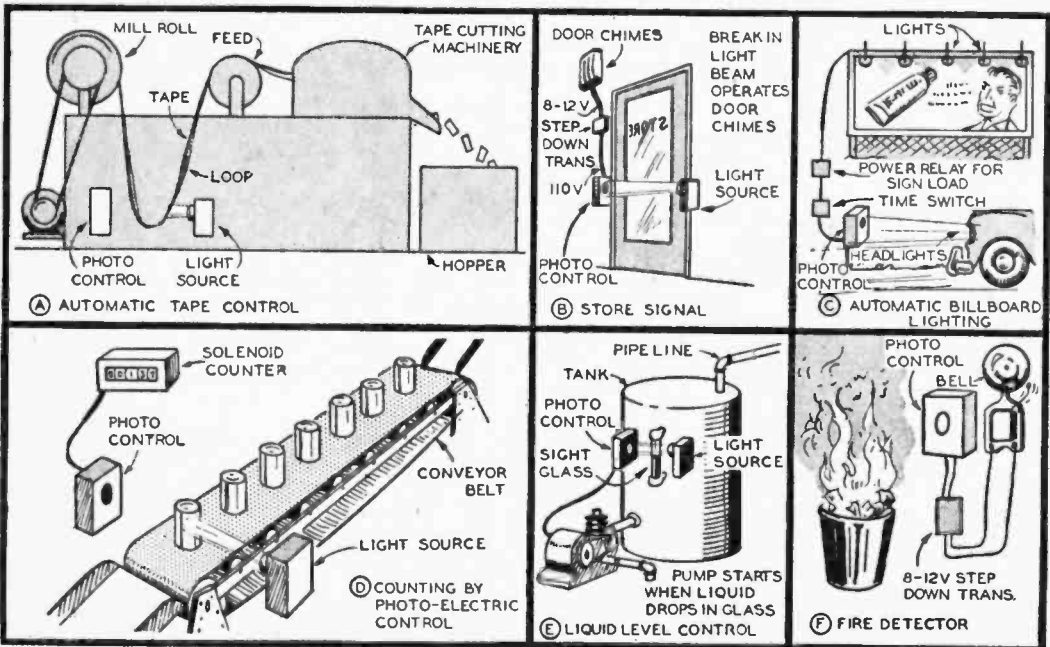

Fig. 2. Practical applications for photo-electric controls.

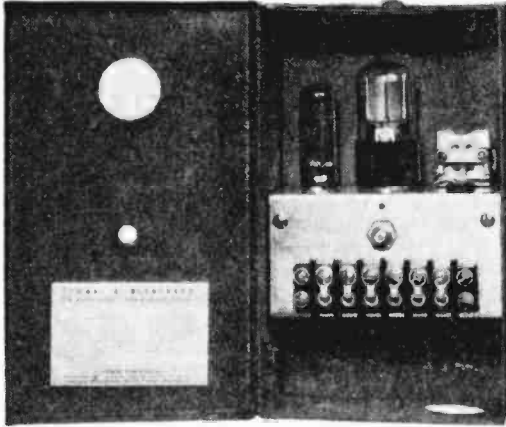

Fig. 3. PE control is housed in standard UL box allowing for permanent installation according to code rules.

struck the photo-electric tube; the 1/4 hp motor turned the abrasive pulley which unwound the tape—pulling the smooth side—until it dropped down, in loop fashion, and cut off the light between photo tube and light source. The tape roll then remained stationary until the machine applying the pads consumed the existing supply of loose tape. As soon as the loop of tape again shortened to expose the light to PE control, the abrasive pulley again unwound more tape, etc.

Controls of this simple PE type are ideal for counting or rejecting cans, boxes, bottles, etc. coming off a conveyor belt (Fig. 2D). Instead of a motor connected to terminals #5 & #6 (Fig. 5), a solenoid counter or “kick” would be attached. Solenoid valves may, likewise, be connected to #5 & #6 where the PE control is used to control pneumatic or steam operated devices.

The control shown in Figs. 5 and 5A is designed to apply 110-120 volts across terminals #5 & #6 when a ray of light strikes the 930 RCA photo tube. There are many instances, however, where a device is to operate only if the continuous light beam is broken. In this instance values of bias resistors, and polarity of the photo tube are modified as shown in Fig. 5B. Form the PE control chassis of #16 gage aluminum to the dimensions shown in Fig. 5, making the socket and component mounting holes and bending chassis to the shape (as shown).

On the top deck of the chassis provide a 1-in. hole for the 930 octal tube socket; a 3/8-in. hole for the 50B5 pentode tube; a 3/8-in. hole for the rubber grommet, plus six 1/8-in. holes for mounting sockets and relay. Slot the center section as shown for

the 6-terminal connecting strip, and drill for four 6-32 mounting screws. The potentiometer mounts in a 3/8-in. hole. For the bottom deck, provide two 1/8-in. holes for mounting the 500 ohm voltage drop resistor.

This PE control uses only standard components available from all radio parts suppliers with the

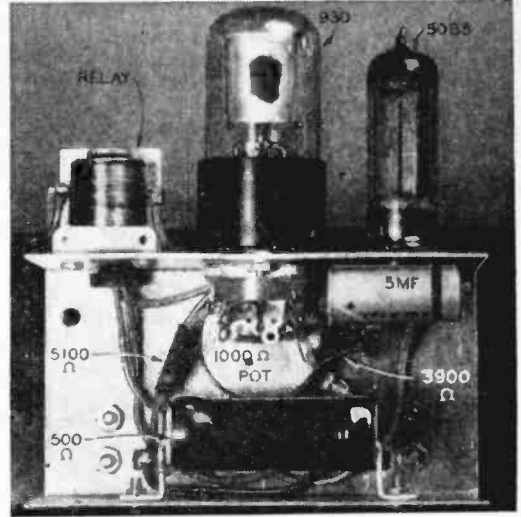

Fig. 4. PE control chassis, rear view. Chassis is in the form of a “C” for protection of components.

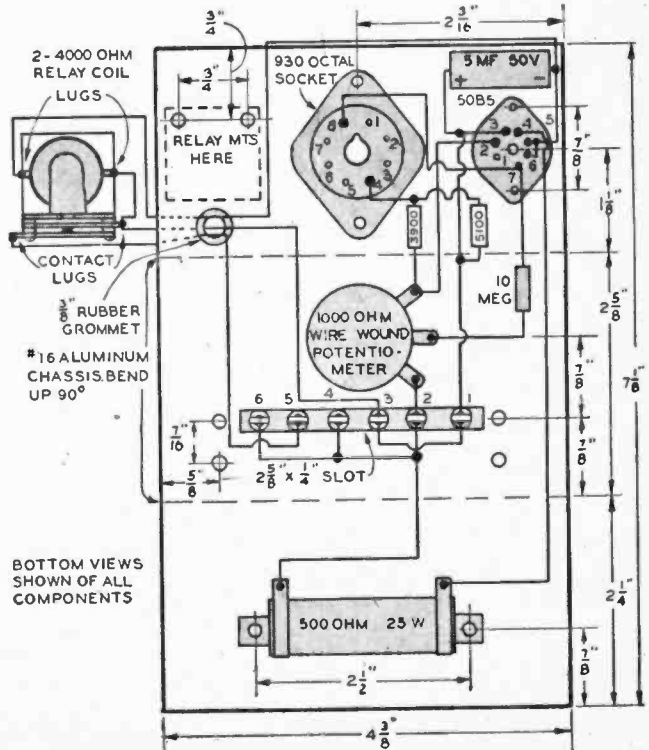
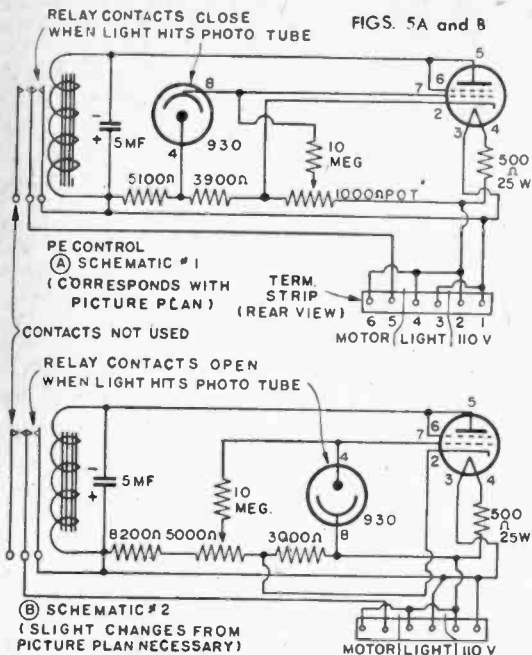

Fig. 5. Pictorial wiring plan and chassis layout for PE control.



rosin core solder (never use acid core). connect 110 volts to terminals #1 and #2. Drill a 1-in. hole in the box cover, along with a 3/8-in. hole to provide access to potentiometer adjusting screw, to permit control to be tested with a flashlight. Attach an ordinary Mazda lamp to screws #5 and #6 to test whether control works properly. Turn the potentiometer to far right, flash a beam aimed at the box opening and then slowly turn potentiometer counter-clockwise until the relay closes and turns on the Mazda lamp. Of course, the control has ample sensitivity to operate on moderate daylight illumination. Passing the hand across the 1-in. box opening should cause the Mazda lamp to go on and off.

The PE control lends itself to fire detection (Fig. 2F), and turning on or off lights with the coming of sunset or sunrise. Billboards along railroad right-of-ways, or highways, may be operated on a time-delay system by approach of train or auto headlights (Fig. 2C).

For industrial applications you need fast and positive control action. In such instances, a concentrated light source is desired so that even a very small object passing through the light beam will produce enough shadow to shade the photo tube and actuate the control. Use any small

exception of the metal housings, which are stocked in various sizes by all electrical supply houses. The boxes are normally used to house time switches, fuse blocks, switch gear, etc. Some boxes, such as the Paragon Type J used here, have two metal mounting ears to which the PE control chassis is secured. You can alter the chassis dimensions to suit the metal box used.

After carefully wiring the control with 50-50 grade

metal container to house the light source; this model (Fig. 6) used a 2x5x3 1/4 in. aluminum box. To obtain the intense, concentrated light necessary, use a 15 candlepower auto spotlight bulb. The 6 to 8 volt lamp operates off a 6.3 volt radio filament transformer rated at 1 1/2 amps (Fig. 6A). Never try to use a bell transformer as they do not have the current capacity needed.

A single contact bayonet socket for the 15 candlepower bulb can be obtained at auto supply stores. Socket is mounted on a bracket over the transformer. In line with the center of bulb filament, a 1-in. hole is drilled in box cover for light to pass through. To concentrate the lamp filament use a simple optical projecting system (Fig. 6A). The lens is an ordinary magnifying type having a focal length, in this instance, of 2 in. and a diameter of 1 5/8 in. A local optician can grind the lens if you don't have a suitable reading glass handy.

To determine focal length, hold lens in front of the box opening and move it back and forth until the lamp filament is seen projected sharply on a wall at least 15 ft. away. The distance

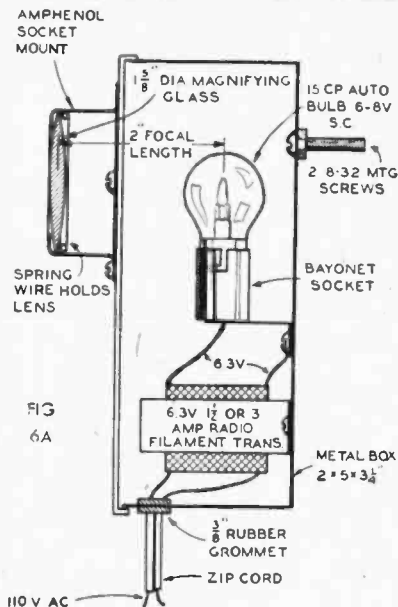
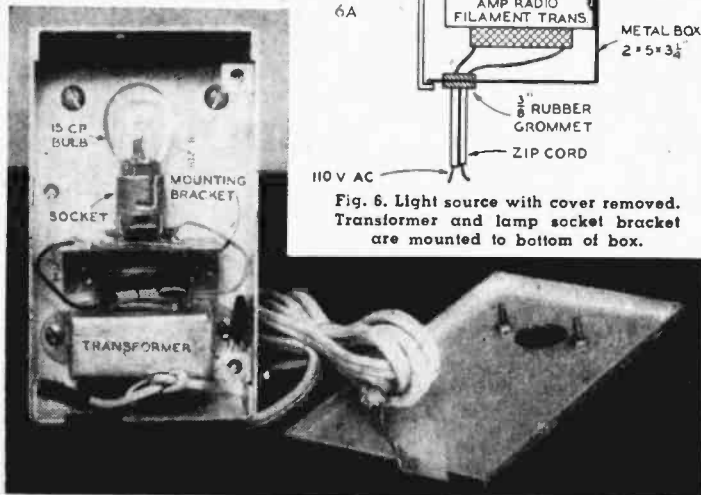

Fig. 6. Light source with cover removed. Transformer and lamp socket bracket are mounted to bottom of box.



MATERIALS LIST—PHOTO-ELECTRIC CONTROL

PE Control Parts

- 1—pc. #16 gage alum., 4 $\frac{3}{8}$ by 7 $\frac{1}{8}$ in. for chassis
- 1—metal electrical box (Paragon J, etc.) approx. 8 x 4 $\frac{1}{2}$ x 3 in.
- 1—Jones Barrier terminal strip #141, 6 screw type
- 1—plate relay, 2000 to 4000 ohms, s.d.s.t. or s.p.d.t. (Allied, etc.)
- 1—500 ohm, 25 watt wire wound resistor (Mallory, IRC, etc.)
- 1—octal plastic-molded or wafer socket (Amphenol, Cinch, etc.)
- 1—7-pin miniature molded or wafer socket (Amphenol, Cinch, etc.)
- 1—5mf., 50v. electrolytic capacitor (C.-D. Aerovox, etc.)
- 1—10 megohm, 1/2 watt carbon resistor, IRC
- 1—type 930 RCA phototube
- 1—type 50B5 miniature pentode tube

- Misc. hookup wire, and hardware as needed; two 3/8" rubber grommets
- Parts for Fig. 5A Circuit
- 1—3900 ohm, 1 watt carbon resistor, IRC
 - 1—5100 or 4700 ohm, 1 watt carbon resistor, IRC
 - 1—1000 ohm wire wound potentiometer, IRC

- Alternates for Fig. 5B Circuit
- 1—8200 ohm, 1 watt carbon resistor, IRC
 - 1—3000 or 2700 ohm, 1 watt carbon resistor, IRC
 - 1—5000 ohm, wire wound potentiometer, IRC

Light Source

- 1—6.3v., 1/2 or 3 amp. radio filament transformer (Stancor, etc.)
- 1—metal box, about 5 x 2 x 3/4" (see text)
- 1—Amphenol "S" Above-Surface Socket Mount
- 1—single contact auto lamp socket
- 1—15 candlepower auto spotlight bulb
- 1—1 $\frac{1}{2}$ -in. dia. reading glass, 2-in. focal length

measured between center of lens and the 15 candlepower lamp is the focal length (Fig. 6A). Should this distance be 4 instead of 2 in., use two lenses in the mount instead of one.

For lens mountings, attach Amphenol above-surface-mount (for Amphenol "S" type radio sockets) over the box cover opening with 3 screws. Fit the 1 $\frac{1}{2}$ -in. dia. lens inside, and secure it with a band of string wire. Where precise focal adjustment is desired, you may slot the bracket to which the auto lamp socket is attached to permit bulb to be moved forward or back in the event that lens used has more or less than an exact 2 in. focal length.—T. A. BLANCHARD.

Handy Counter from Radio Dial

• When keeping count of various products, jobs or parts you won't have to use paper and pencil, or rely too much on the memory, if you make this handy counter from a radio tuning dial salvaged from an old battery radio or from the junk yard. Mount the dial on a 1 in. thick hardwood base with a hardwood peg friction tight in the dial hole. Peg length and diameter depends on the dial hole.—A. TRAUFFER.

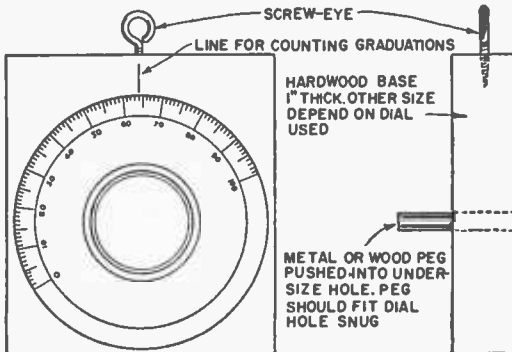

SUPER-POCKET RADIO

ELECTRON TUBE TYPE—PLASTIC CASE \$3.95

Smaller than many hearing aids. Simple, unique kit anyone can assemble & wire. Long-distance, highly selective circuit. Up to 1500 mt. range. Local station's volume often Post too loud for comfort. Uses two paid inexpensive cells which fit inside plastic case. Complete kit, including tube only \$3.95. Battery & earphone available extra. Supply limited—order now!

ELECTRO-MITE, Springdale, Conn.

TRANSISTOR RADIO

This vestpocket radio operates for several weeks on a single 1 $\frac{1}{2}$ v. penlite battery. Kit includes plastic case, phone jacks, germanium diode, ferrite tuner and knob, ceramic and paper capacitors, resistor and hook-up wire. Provides extra-powerful reception on local and strong distant stations. Set operates in most areas simply by attaching antenna lead to any convenient metal object. A really novel radio kit for only \$3.50. Transistor \$1.50 extra. May be used for Transistor Experiments, too.

\$3.50

POCKET CRYSTAL RADIO

Powerful and Highly Selective with Ivory Plastic Case

This vestpocket crystal radio employs a diode detector with amazing ferrite coil, featuring inductive micrometer knob tuning. Kit includes all components to assemble this amazing net (except headphones) at bargain price of \$2.99.

\$2.99

ELECTRO-MITE Springdale, Conn.

FOUNTAIN PEN RADIO

A really novel radio kit. Includes a standard size plastic ball-point pen (that writes!), germanium diode, micro-meter ferrite tuner, phone clips, ceramic capacitor and hook-up wire and clips. Provides excellent reception on local and powerful semi-distant stations, usually without an outside antenna. Only requires an hour or so to assemble this unusual receiver that will amaze your friends. Kit is complete except for headphones which you may have, or can order below. Pen Radio Kit, \$3.00 postpaid.

\$3

FERRITE CORE COILS

"Supercharges" Small Sets

This amazing coil replaces old loop in AC-battery portable or table sets. Brings in stations often never heard before. This coil used in many projects described in this manual. Installed in a couple minutes. Only 99¢ postpaid.

ONLY 99¢

ELECTRO-MITE Springdale, Conn.

ACCESSORIES

Sensitive Double Head.ets. \$2.25 pair. Radio Soldering Irons. \$1.98. Special radio solder, 25¢ hank. Heavy aluminum boxes for experimenters (5x3x2-in.) \$1.00. Aluminum (soft) for panels/chassis, 5x5-in. plates \$1.44 gage 49; 5x10-in. plates, 89¢; 5x15-in. plates, \$1.29. Plastic boxes (heavy-clear acetate) size 3x3x1-in. 30¢ ea. Sensitive electronic control relays, 5000 ohms, SPST (norm. open) \$1.08.

POCKET TUBE CHECKER

Locates TV-Radio Tube Defects

This kit contains all necessary components for assembling the Pocket Tube Checker described in this manual, except box and wire. Tests hundreds of types of radio and TV tubes for shorts, burn-outs, etc. Also functions as radio-electrical continuity tester. Parts and punched aluminum panel ready to wire and mount in your own box ONLY \$2.99.

\$2.99

ELECTRO-MITE Springdale, Conn.

HOW TO ORDER

Remit by postal, express, or currency exchange money-order, check, or cash (at your risk). C.O.D. orders must include \$1 deposit. Please order from this page as we do not publish a catalog. Complete details on kits are in this manual.

ELECTRO-MITE

Reg. U. S. Pat. Off.

P.O. BOX 636 SPRINGDALE, CONN.

Little SQUIRT

A remote radio-controlled, one-half-inch-to-the-foot scaled model of a modern fire boat

By DICK EALY



Craft Print Project No. 214

PART 1

THERE are no strings attached to this model. It is radio-controlled so it can be maneuvered in the water by a remote transmitter. Even the water pump, which shoots a stream of real water through its gun-type nozzles, is remotely controlled. Two electric motors drive the miniature at a fast clip as though it were in a hurry to get to a fire. With a little imagination, you can even pretend you are watching this little fellow's big brother or prototype—an eye-catching fireboat designed by naval architect John G. Alden of Boston for the Harbor Department of the City of Long Beach, California.

Before you start to build this boat, study the hull framing (Fig. 2). Then lay out on wrapping paper the keelson, stringers and planking strips full size from the dimensions in Fig. 1. The curved lines can be drawn with a wooden strip held in place with straight pins as in Fig. 3. Transfer the outlines to balsa stock and cut them out.

The bulkheads (Fig. 4) can be drawn direct-



Testing water monitors on prototype of model fireboat at Long Beach, California. Water monitors on model are remote controlled.

ly on $\frac{3}{32}$ -in. balsa stock and cut out. Be sure to mark the location of the $\frac{1}{8}$ -in. balsa blocks. When cutting the notches for the keelson and stringers first make them slightly undersize, then test fit them in their respective notches and file to obtain a perfect joint.

Measure and mark the location of each frame on the keelson from dimensions in Fig. 5, and prop it up in its normal position on a flat wooden surface with blocks nailed temporarily

between the frames (Fig. 6A). Note that the front is $1\frac{15}{16}$ in. higher than the part touching the surface. Now glue and slide the bulkheads down on the keelson, checking each with a square to make sure it is vertical with the surface of the table. Then place a $\frac{1}{8}$ x $\frac{1}{4}$ -in. balsa center stringer in its notches and fasten with Wilhold white glue. The next step is to glue the stringers in their respective notches. Start with the inwhale stringers, then the upper chine stringers and lower chine stringers and

then finish with the deck stringers. Be careful not to bow the keelson to one side or the other when adding the stringers. Use a sanding block along all stringers to bevel the edges so that they will blend with the bulkhead sides. Between bulkheads you can now add the hull ribs (Fig. 6B), cutting and fitting them from $\frac{3}{32}$ x $\frac{3}{16}$ -in. hard balsa or pine stock (Fig. 5).

Now remove the temporary blocks and turn the frame upside-down. Fasten the bottom

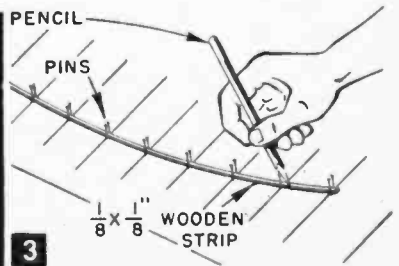
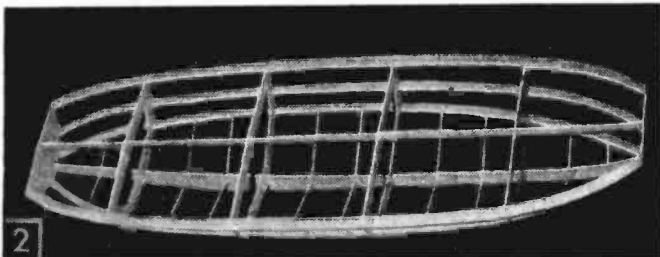
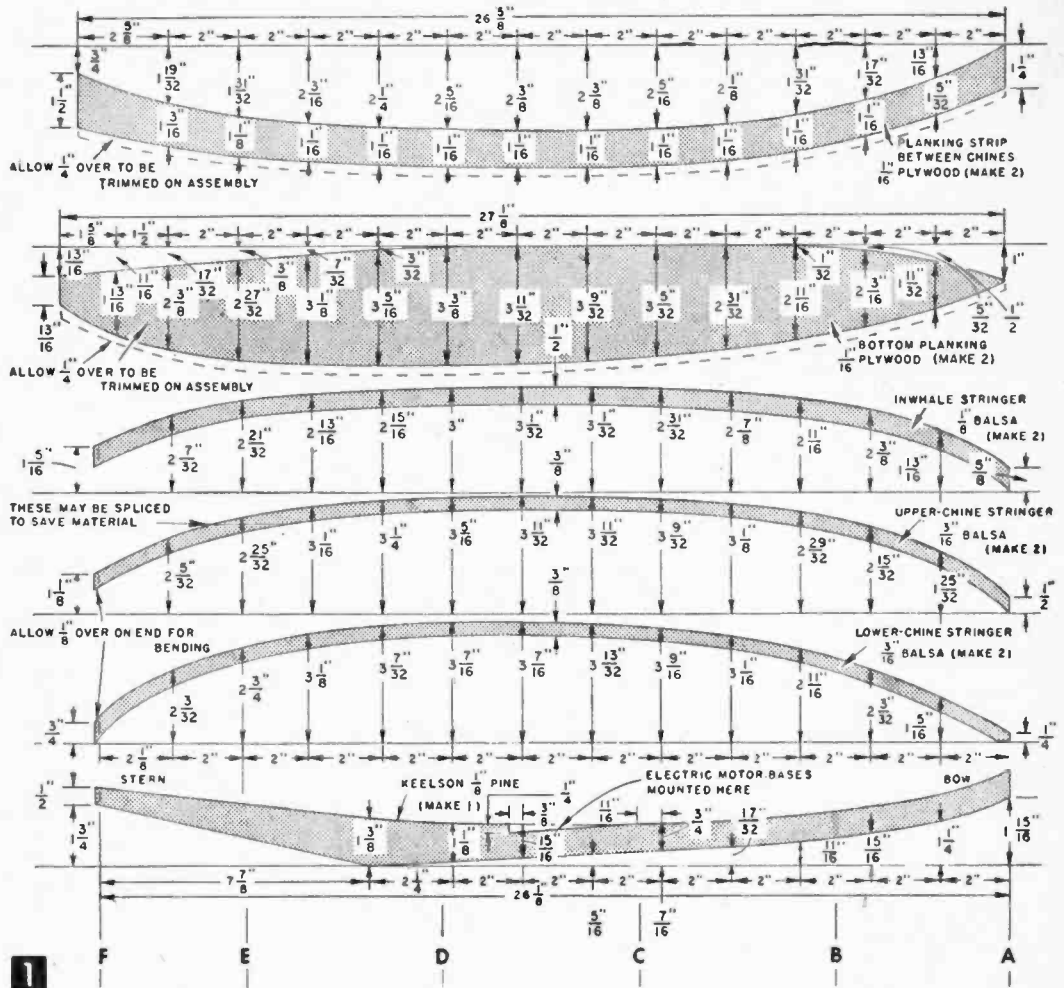

GENERAL NOTES

1. BULKHEAD DIMENSIONS ARE THE SAME TO THE LEFT AND RIGHT OF THE CENTERLINE
2. BULKHEADS ARE $\frac{1}{8}$ " BALLS ON PINE
3. HATCH STOPS ARE $\frac{1}{8}$ " SO BALLS
4. ALL CHINE STRINGERS AND TRIM TO BE TRIMMED FOR HULL JOINTS.

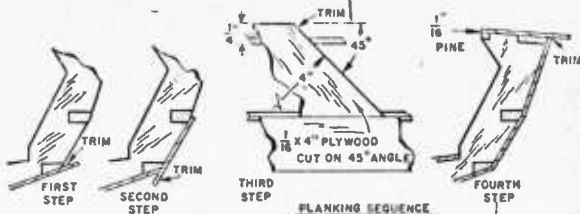
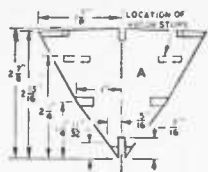

hull planking first (Fig. 6C), using masking tape, clamps and clothespins to hold the 1/16-in. plywood planking in place. When the glue is dry, trim the projecting edges with a knife to within 1/32 in. of the stringers, then sand down flush with the edge of the stringers using a sanding block and #2 garnet paper. Plank the section between the upper and lower chine stringers next. The top edge of the planking is placed to cover one half of the upper stringer edge. The other edge projects beyond the bottom planking (Fig. 4). When the glue is dry, trim the bottom edge and sand it flush with bottom planking. The upper side is planked with 1/16-in. plywood cut so that the grain in the outer plys is at a 45° angle with the hull stringers (Fig. 4). This will enable you to easily bend the plywood around the sharp curves at the bow and stern. Trim the surplus away with a knife and sand the top edge down flush with the inwhale stringer. Plank the deck edges with 1/16-in. plywood again leaving a little stock projecting out to be trimmed after the glue dries. The bow and stern are shaped from solid blocks of balsa (see materials list) and glued to bulkheads A and F. Use a sharp knife and sandpaper to shape both blocks to the lines of the ship (Figs. 5 and 6). Then sand the entire hull, first with #1 paper followed with #400 sandpaper.

Construction of the three hatches or deck plates (Fig. 8) is completely detailed in Fig. 7. Cut out all of the pieces first, then assemble them fitting each piece with the hull to assure a snug sliding fit between the deck stringers.

The propeller-shaft installations (Fig. 9) are next. Make up the 1/8-in. dia. brass-tube supports and solder them to the stuffing boxes at the 29° angle as shown. Cut holes in the bottom of the hull and glue the two stuffing boxes in place. Install the 1/8 I.D. x 3/8-in. brass-tube outer stem for both rudders.

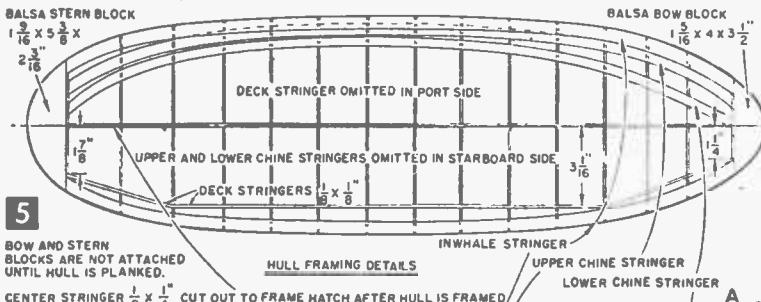
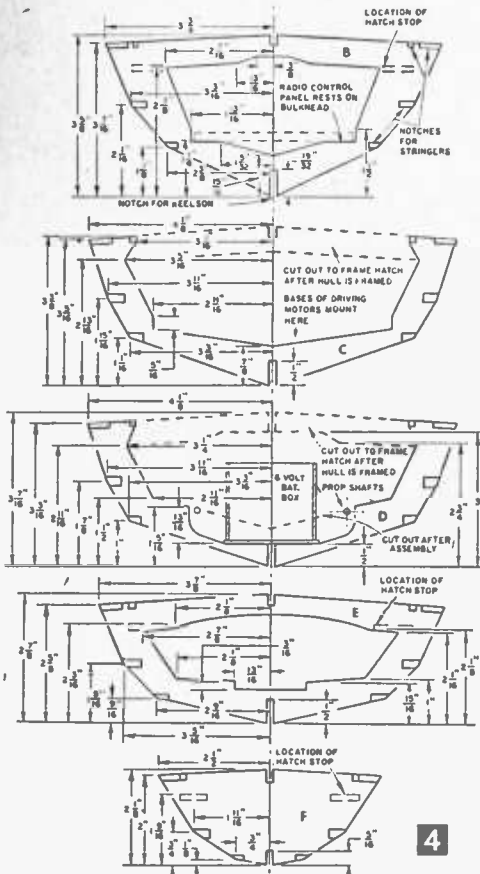

BOW AND STERN BLOCKS ARE NOT ATTACHED UNTIL HULL IS PLANKED.

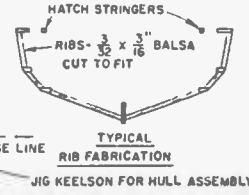
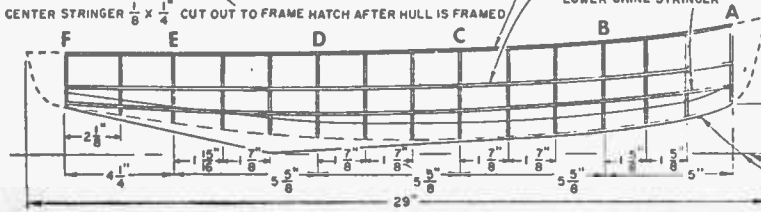

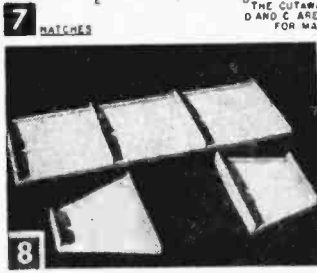
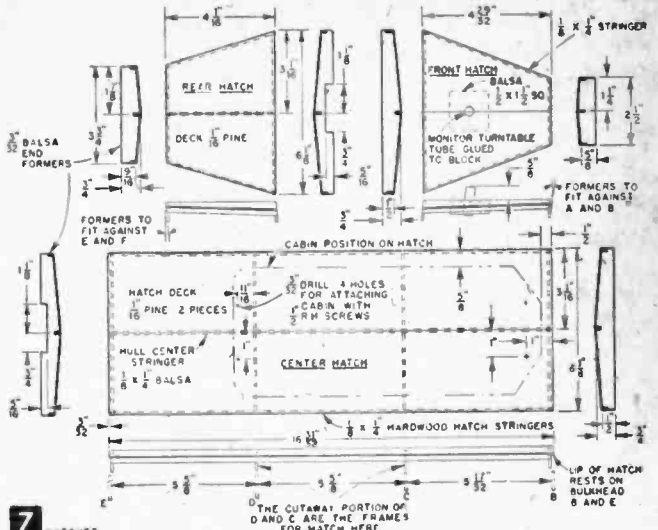
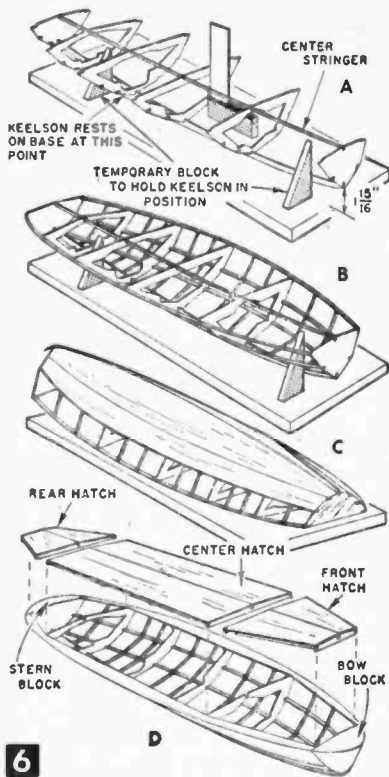

These are glued in the hull at the top and soldered to the flattened rear ends of the 1/8-in. dia. support tubes. Slip the 1/8-in. I.D. brass-tube bearings over propeller shafts and solder the 1/32 x 1/4-in. brass struts in place (see L-L Fig. 9).

MATERIALS LIST—LITTLE SQUIRT (All dimensions in inches)

| No. | Size & Material | Use | No. | Size & Material | Use |
|---------|-------------------------------------------|-----------------------------|--------|-----------------------------------------------------------|------------------------|
| 1 | 1/8 x 2 1/4 x 26 1/8 pine | keelson | 2 | Electric Drive Motors Permag DC-1 | |
| 2 | 1/16 x 4 x 36 pine | hatches | 2 | stuffing boxes for 1/8 shaft | shaft bearings |
| 2 | 3/16 x 4 x 36 hard balsa | chine stringers | 2 | propeller shafts 1/8 dia. x 12 steel | |
| 1 | 1/8 x 4 x 36 hard balsa | inwale stringers | 2 | 1/8 I.D. x 3/8 brass tube | shaft bearings |
| 1 | 1/8 x 1/4 x 36 hard balsa | center stringer | 1 | left-hand 3-bladed bronze propeller | |
| 2 | 1/2 x 4 x 36 hard balsa | bulkheads | 1 | 1 1/2 dia. x 3 pitch right-hand 3-bladed bronze propeller | |
| 1 | 1 1/16 x 4 x 3 1/2 soft balsa | nose block | 1 | 1/2 dia. x 3 pitch | |
| 1 | 1 1/16 x 5 3/8 x 2 3/16 soft balsa | stern block | 2 | 1/32 x 1 1/2 x 3 brass sheet | rudders |
| 1 | 1/4 x 3/4 x 16 balsa | braces | 1 | 1/32 x 1/4 x 18 brass strip | struts, rudder tie bar |
| 1 | pint white synthetic enamel | hull primer | 2 | 1 radius die-cast aluminum filler arms | radio rudder control |
| 1 | pint French Gray synthetic enamel | hull paint | 1 | E. D. clockwork escapement | |
| 1 | half pint dark red synthetic enamel | hull paint | 2 | plastic tubing 1 long for 1/8 shafts | |
| 1 | 3/4 x 6 x 2 1/4 birch wood | stand | 4 | 1 x 1 x 1 1/2 long aluminum angle | motor brackets |
| 2 | 1/2 x 3 x 6 birch wood | stand racks | 8 | 3-48 x 1/2 machine screws and nuts | |
| 4 | 1/2 x 3 felt | rack pads | 1 | dozen #2 rh 3/8 brass screws | |
| 1 | 8 oz. Testor's sanding sealer | stand finish | 1 | dozen #2 rh 1/4 brass screws | |
| 1 | 4 oz. Wilhold glue | adhesive | 6 | 1/16 x 4 x 28 birch or poplar exterior plywood | planking |
| 1 | 1/16 dia. x 2 steel wire | sliding pin | 24 | 2-56 x 1/2 machine screws and nuts | cabin |
| 3 | 1/8 O.D. x 12 brass tube | rudder stem & shaft support | 2 | 1/16 x 4 x 36 balsa | |
| 1 | 1/8 I.D. x 8 brass tube | rudder stem | 1 | Telecommander Receiver 951 A | |
| 1 | 1/16 I.D. x 1 brass tube | sliding pin | 1 | Telecommander Transmitter 1061 | |
| 1 | 1/2 x 3 x 18 balsa | cabini, reels, seats | 4 | toggle switches SPST | |
| 1 | 3/2 x 1 3/4 x 3 1/2 balsa | seat | 1 | 5000-ohm Clarostat potentiometer series 43 | |
| 2 | 1 1/4 sq. x 1 3/8 balsa | reel cores | 1 | 4 point jack plug | |
| 1 | sheet Japanese tissue white paper 24 x 30 | | 1 | 6-volt Willard NT-6 wet cell battery | |
| 1 | 4 oz. clear dope Testor's | | 2 | 67 1/2-volt K-45 "B" batteries for the boat | |
| 1 | 8 oz. sanding sealer Testor's | | 2 | 67 1/2-volt VS-0116 "B" batteries for transmitter | |
| 1 | 1 oz. pla. gold paint Testor's | | 1 | 1 1/2-volt VS-070 battery for transmitter | |
| 1 | 4 oz. black sta. Testor's | | 3 | condensers .1 MFD 200 VDC | |
| 1 | tube Testor's cement | | 1 | condenser 50 MFD 25 VDC | |
| 2 | 1/16 x 36 dia. steel wire | | 1 | relay 5000 ohm #5 A | |
| 3 | 1/16 O.D. x 12 brass tube | | 1 | resistor, 25,000 ohm | |
| 13 ft. | 1/2 dia. black rubber tubing | | 1 | relay, 6 volt | |
| 1 | 6 x 6—1/32 plastic | | 15 ft. | plastic-covered ignition wire | |
| 1 | 3/16 x 3 1/4 x 4 3/4 plywood | | 1 | centrifugal water pump and bracket | |
| 1 | 3/32 x 4 dowel | | 1 | electric motor DC-1 Permag for pump | |
| 1 | 3/16 dia. x 36 dowel | | 2 ft. | plastic tubing for 3/16 tube | |
| 1/2 pt. | white enamel | | 2 | 1/16 O.D. x 12 brass tube | |
| 1 | 1 1/2-volt medium dry cell battery | | 2 | brass turned water monitors | |
| | | | 1 | U.S. flag, silk, 1 1/2 x 2 | |

Special Parts: Model Craft Mfg. Co., 3455 W. 6th St., Los Angeles 5, Calif.
 Fittings: 2 brass bits 3/8 dia., 4 cleats 1/2 long, 4 tanks fillers, 2 anchors 1 1/2 long, one foot brass chain 16 link per inch, 6 capstans 1/4 high, 1 castan 3/16 high, 1 brass bell 1/2 dia., 1 searchlight, 1

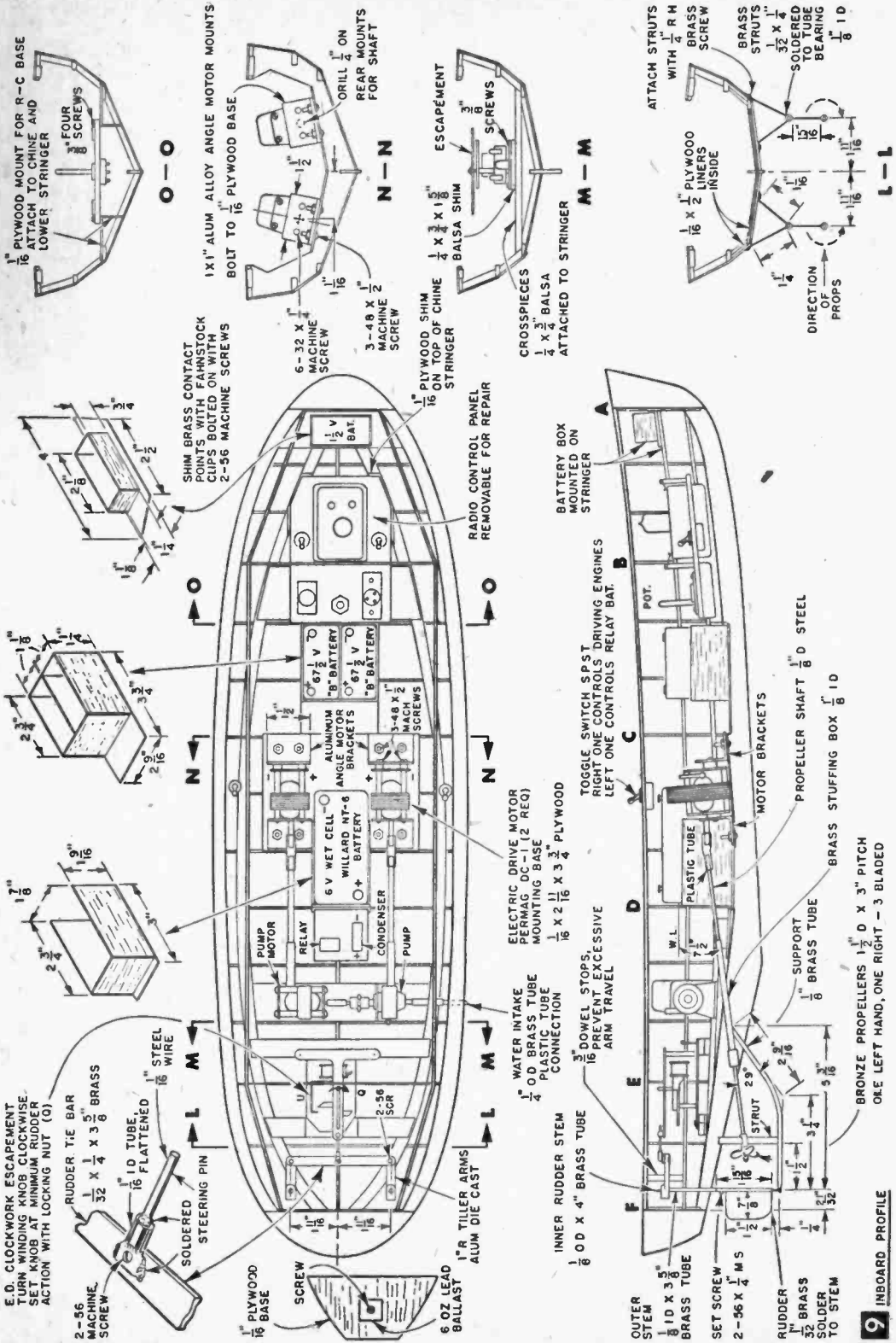

Add the $\frac{1}{16}$ x $\frac{1}{2}$ -in. plywood liners inside and secure the struts with $\frac{1}{8}$ -in. rh brass screws.

Gently saw the $1\frac{7}{8}$ -in. long segment of stem tube for the rudders out of the vertical outer stem. Solder the brass rudders to them. Replace tube and slide the $\frac{1}{8}$ -in. O.D. brass inner stem down to hold rudders. Drill #50 and tap 2-56 thread through all but outer wall of stems and tubes for the set-screws. Remove the rudders and propeller shafts for painting.

Before painting, fill all the cracks in the hull with putty or *Plastic Wood* and give the hull two coats of white synthetic enamel primer on both inside and outside surfaces. The interior should be sanded if necessary. The outside is sanded after each coat with wetted #400 paper. The painting specifications for the full-size ship called for a gray color between Navy Gray and Coast-Guard Gray. A synthetic French Gray enamel was used on the miniature. Brush on two coats allowing 24 hours to dry between coats. Paint all surfaces below the water line of the boat with a dark red enamel. Use masking tape to protect the gray upper hull when applying the red. Paint the hatches with the same gray used on the hull.

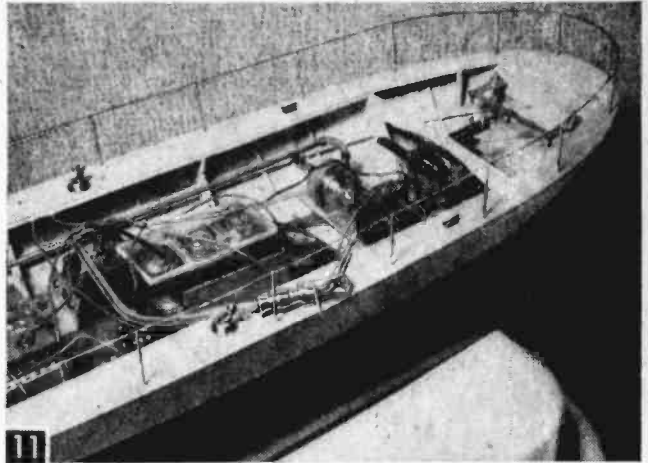

tors and bases. Scrape away paint where the bases touch the keelson, bulkhead C and hull bottom. Glue the bases in place so that motor shafts are in alignment with propeller shafts. Then slip a piece of plastic tubing over motor and propeller shaft ends to act as a universal joint. Fasten the three-bladed bronze propellers in their proper places with socket set screws.

Add Ballast for Balance

Ballast must be added at the stern (Fig. 9). Bolt a piece of lead weighing 6 oz. to $\frac{1}{16}$ -in. plywood shaped to fit in the hull at the stern on top of the lower chine stringers. Glue the plywood permanently in place. Then make the three $\frac{1}{16}$ -in. plywood battery boxes (Fig. 9) and glue them in their respective places in the hull after first scraping away the paint for a better glue bond.

Attach the two die-cast tiller arms to the inner rudder stem with set-screws. Make the rudder tie bar (Fig. 9) and bolt to the tiller arms. In the center of the tie bar drill and bolt the steering pin. This is also soldered to the tie bar at 90 deg. to assure smooth steering. A British-made E.D. clockwork escapement is recommended for steering the boat. Loosen the winding-knob adjustment nut on the underside and move the knob in toward the center to reduce rudder action to its minimum. Scrape away the paint on the lower-chine stringers and glue $\frac{1}{4}$ x $\frac{3}{4}$ -in. balsa crosspieces in place. Shim the escapement up with brass washers so the steering-arm knob and the steering pin are aligned horizontally.

Next, secure the escapement with #2 $\frac{3}{8}$ -in. rh brass screws. Now wind up the knob clockwise and press the escapement at U in Fig. 11 to release starwheel and observe how rudder turns to one side, press again to bring it back to center, press a third time to turn to the other side, and press a fourth time to return to center. Make any adjustments at this time to assure smooth action.

Installing the Twin Screws

After the paint is dry, clean out the propeller and rudder-shaft bearings and stuffing box of any paint that might have leaked in. Replace the rudders. To prevent marring the paint and damaging the rudders and propeller supports, make the hull-support stand detailed in Fig. 10. Use three coats of Testor's sanding sealer for a natural-wood finish on the stand.

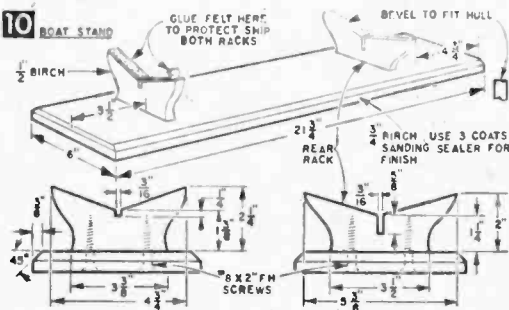

The electric motors for the propellers are installed next. Cut two pieces of plywood $\frac{1}{16}$ x $2\frac{1}{16}$ x $3\frac{3}{4}$ in. for the motor-mounting bases. Aluminum angle stock is used for motor-mounting brackets but since most extruded aluminum angles are not square (about 88 deg.), it must be straightened to 90 deg. Then, carefully drill $\frac{1}{64}$ -in. holes in the brackets for bolting to mo-



Little SQUIRT

Part 2. Installing the radio controls, deck fittings, water pump, and building the cabin to complete this realistically-scaled fireboat

By DICK EALY

Craft Print No. 214

WHEN you have the hull built and the electric-powered twin screws installed according to the instructions given in Part 1, you're ready to put in the Citizens' Band 27.25 mc radio controls for steering and operating the water monitors, build the cabin, and fit out the fireboat with all the trimmin's like its big brother of the Long Beach, Calif. Harbor Fire Department.

The British-made Telecommander 951A radio receiver and crystal-controlled transmitter 1061 were used. They have proved themselves to be rugged and easily adjusted. Other radios may be used, however the radio-control (R-C) panel may have to be altered to accommodate another make.

Make the R-C panel (Fig. 13) by drilling and sawing out the necessary holes for the sockets, switches, potentiometer receiver and $\frac{3}{10}$ -

in. dowels. Install the parts and suspend the receiver between the dowels with rubber bands as shown to minimize vibration. With the Telecommander set comes an excellent set of instructions and wiring diagram. Study the hook-up drawing because we have adapted it for use in the fireboat. Use multi-strand wire and solder all joints. By using a 4-point jack plug the re-

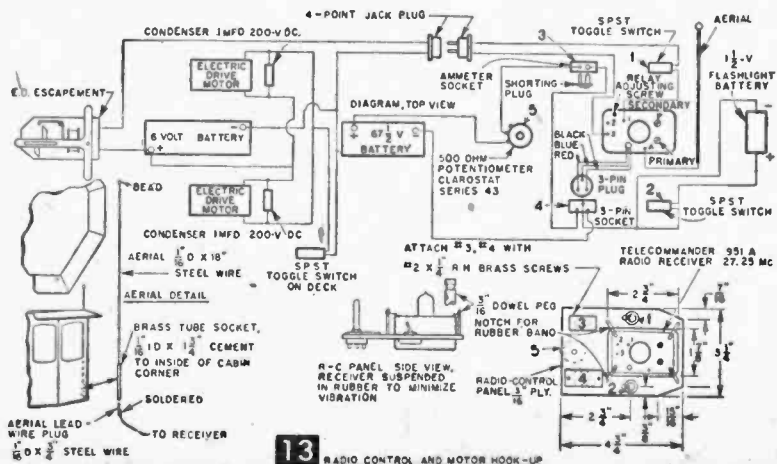

13 RADIO CONTROL AND MOTOR HOOK-UP

ceiver panel can be easily removed for inspection and repair through the front hatch. Run all wires from this jack along the bulkheads on the left side of the hull (Fig. 14). Fasten small alligator clips to each lead coming out of the main wet-cell battery so it can be easily taken out for charging (Fig. 13).

Originally the aerial was located alongside the flag mast as shown in Fig. 12 and the photos of Part 1 but, the long horizontal lead wire from the receiver made the aerial too sensitive. The new forward aerial position (Fig. 13) corrects this condition. Cement a 1/8-in. brass tube to the inside of the cabin wall for a socket (Fig. 13) and solder the aerial lead wire to a 1/16-in. steel wire for a plug. Use an 18-in. length of 1/16-in. steel wire for the aerial. Insert it through a hole in the cabin roof and into the brass lead-wire socket. Be sure to fasten a small bead or ball to the top of the aerial to protect your eyes when handling the completed boat.

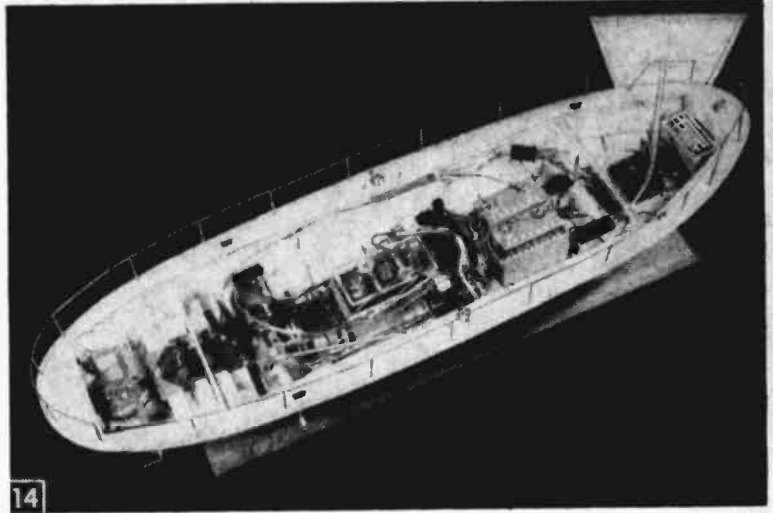

All radio and mechanical parts in hull are accessible when fore and aft hatches and cabin are removed.

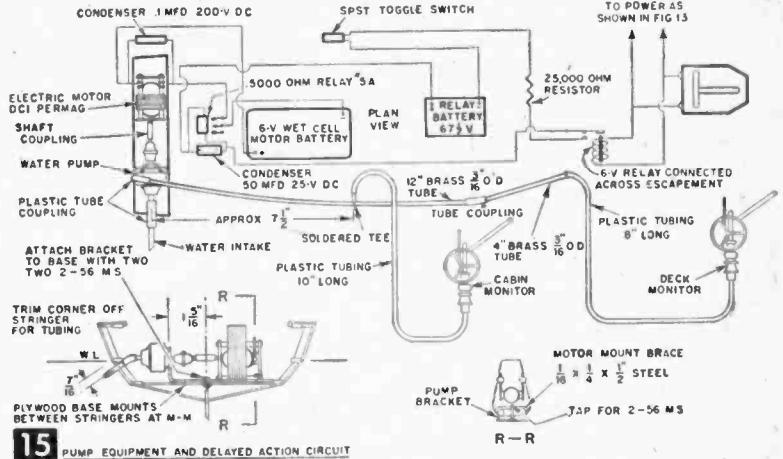

For ammeter tests, make a shorting plug (Fig. 13) to place in the ammeter socket. This is merely a piece of wire soldered across two pins. When placed in the line for regular use, this plug allows the current to flow through the line. We tied a piece of thread to the plug and the nearest post supporting the receiver so the plug would not get lost.

The water pump installation is the next step. Fasten one of the DC-1 Permag electric motors to the water-pump bracket as shown in section R-R, Fig. 15. Use a 1 1/4-in. length of plastic tubing as a shaft coupling. Cut a piece of 1/16 x 1 1/4-in. plywood base to fit between the lower-chine stringers and bolt the bracket and base together with 2-56 x 3/8-in. machine screws and nuts. Slip a 1-in. length of plastic tubing over the center intake tube of the pump, and a 1/4-in. dia. x 1 1/4-in. long brass tube on other end of the plastic tube for water intake. Fit the pump assembly in the hull and drill a 1/4-in. hole through the hull

(Fig. 15). A little of the corner of the upper stringer may have to be trimmed away to allow the intake tube to pass through. Glue the plywood mounting base to the hull and cement the intake tube to the hull. Scrape the paint away around the hole before cementing for a better bond. Now make the tee joint in the brass tube (Fig. 15) which carries the water forward from the pump to both monitors. Hook the brass tubing up with plastic tubing connectors. The tube should run as close as possible to the bulkheads along the inside of the ship.

The delayed-action circuit operating the water pump requires a 50 MFD 25-V, DC condenser and a very sensitive adjustable point 5000-ohm relay #5A. When the right button of the transmitter is touched and released the rudder turns. But, when the same button is held down the water pump cuts in about a second later. Mount the relay and condenser on a piece of 1/2 x 1 1/4 x 1 3/4-in. wood. The leads of the condenser are

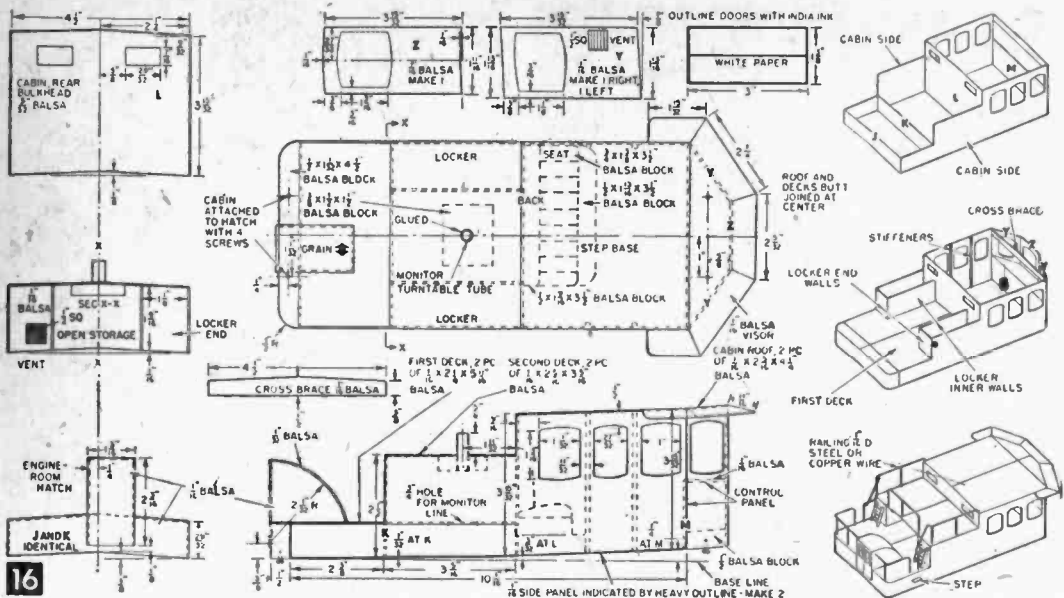

16

connected to the relay coil points (Fig. 15). Glue the plywood to hull keelson behind the battery box for the 6-V wet-cell battery (Fig. 9, Part 1). Hook up the circuit as shown in Fig. 15.

Start the cabin construction next. Cut out the two side panels (Fig. 16) from $\frac{1}{16}$ x 4-in. sheet balsa. Then cut out bulkheads J, K, L, M, and

assemble by cementing J and M between the sides and then add K and L. Cut out one right and one left cabin corner piece Y in Fig. 16 and the cabin front piece Z. Cement these three to the cabin front end. Add the control panel and $\frac{1}{2}$ -in. thick balsa piece across the bottom of the cabin front. Cement a $\frac{1}{2}$ -in. balsa block to cabin

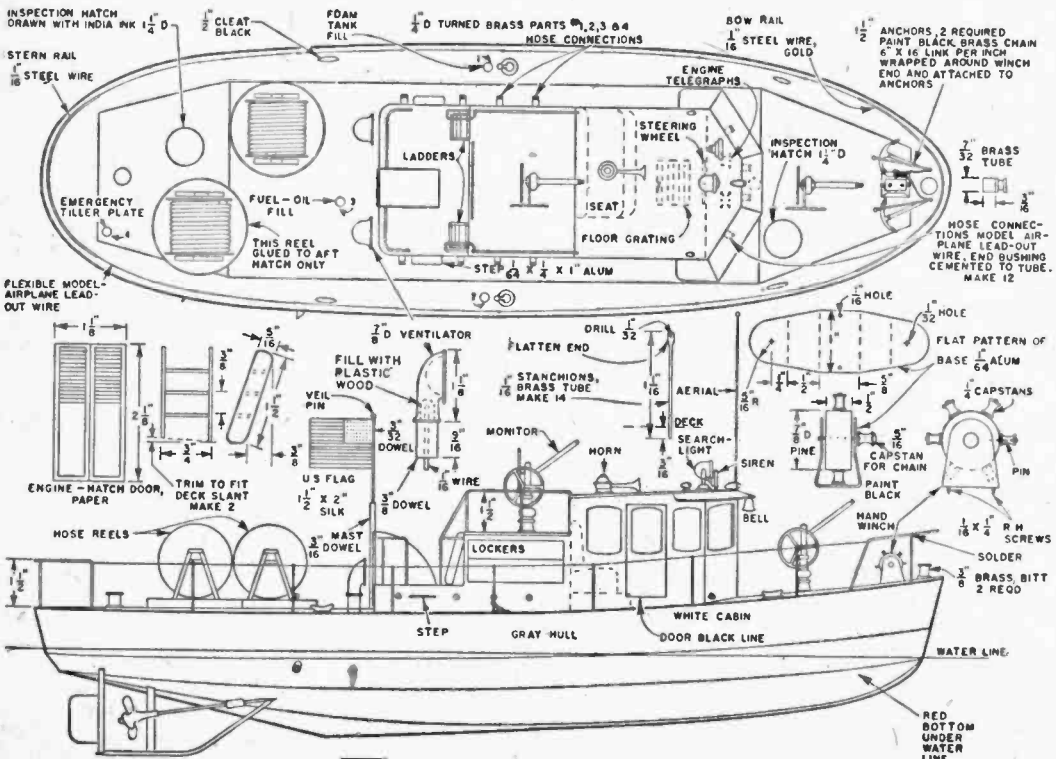

17

OUTBOARD PROFILE AND DECK PLAN



18 Most of the deck accessories, which lend realism to the model, are purchased model ship parts.

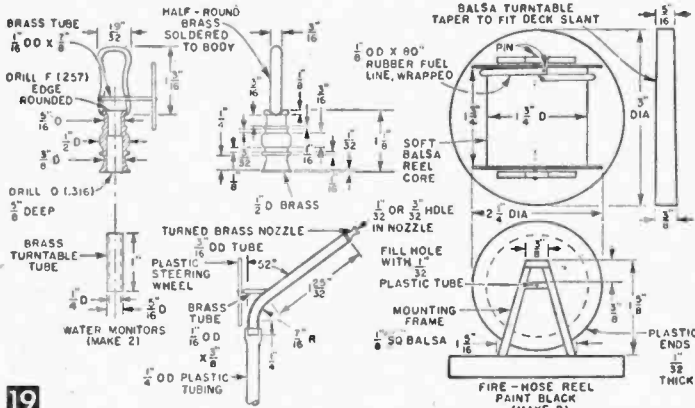

19

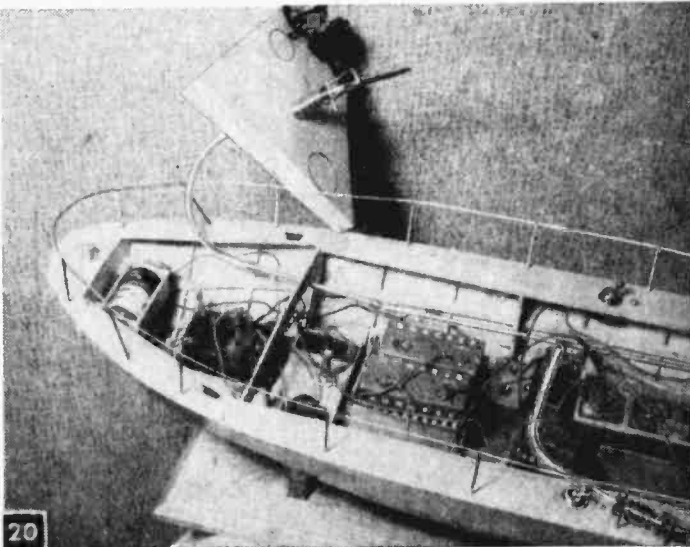

20

rear end and round the corners. To strengthen the sides cement the balsa stiffeners between the windows. Plank the first deck with two pieces of balsa placed between the cabin sides. Then add the end and inner locker walls and plank the second deck. Cut and cement the cabin cross brace between the sides and plank the cabin roof using four pieces of balsa. Add balsa visors.

To make the engine-room hatch, cement the side pieces to the cabin first. Then cut the top with the balsa-wood grain running across the short dimension and bend and cement to the curved sides. Cut and cement the $\frac{3}{8}$ -in balsa block under the 2nd deck.

Sandpaper the cabin smooth with #400 sandpaper and brush on one coat of clear Testor's dope. Sand again and then cover the cabin with Japanese tissue using dope as an adhesive. Wet the paper with water before the dope dries and it will shrink smooth and tight. Brush on one more coat of dope and sand with #400 sandpaper. Then prime the cabin using the same white paint as used on the hull. Sand it with #500 wetted paper and brush on two coats of white enamel.

Make up the seat and berth from balsa. Brush on two coats of Testor's sealer and sand with #400 sandpaper. Finish with three coats of black STA dope and glue the seat to bulkhead L. The other cabin-interior parts, the plastic steering wheel, engine telegraphs and floor grate, are purchased parts and need only be cemented in place (Fig. 17).

Now you can begin to add the "frosting to the cake" as you finish the cabin exterior (Fig. 18). For the railing, use $\frac{1}{16}$ -in. diameter steel or copper wire and cement it in holes drilled in the cabin. Railing braces are soldered in place (Fig. 16). Paint the rails with gold PLA; two coats are necessary and 24 hours between coats for drying time. The engine hatch doors, locker doors and vents are made of paper. Use a draftsman's ruling pen and India ink for the lines. Then cut them out and cement in place on the cabin.

Make the two ladders (Fig. 17) of $\frac{1}{16}$ -in. mahogany plywood and brush on three coats of sanding sealer for a polished finish. Glue the ladders in

Eight-inch length of plastic tubing to monitor permits removal of forward hatch to inspect radio receiver.

YOUR
NEIGHBORHOOD
NEEDS AN
ELECTRICAL
APPLIANCE

TROUBLE SHOOTER

Men needed to repair and service all kinds of electrical appliances—AUTOMATIC WASHERS • DRYERS • IRONS • VACUUMS • TOASTERS • REFRIGERATORS • FANS • HOME FREEZERS • AIR CONDITIONERS —Home and industrial wiring.

Big, Year-'Round Profits!
HELP US FILL HUGE DEMAND

MODERN BIG PROFIT ONE-MAN BUSINESS
YOURS AT HOME — SPARE OR FULL TIME.

No previous experience needed. New, visual "Shop-Practice" method quickly shows you how. Hundreds of plain-as-day "How to" photos and drawings make it easy. A corner of garage, porch, attic, or basement is all the space needed. No costly leases—no big overhead. We show you how to make business come to you.

NEW 30-DAY INCOME PLAN!

Shows you how to start your own Big Profit Business without investment—no big overhead

COMPLETE OUTFIT
YOURS TO EXAMINE
AT NO RISK...

BIG MONEY, SECURE FUTURE—INDEPENDENCE.

F. V. in N. Y. says, "I made \$300 in 3 months while studying." T. E. H. in W. Va. says, "Made \$14 a day while learning." In addition to instructions you get a kit containing professional appliance tester and tools. Everything furnished to help you build your own big profit business at home. COMPLETE OUTFIT YOURS TO EXAMINE, AT NO RISK. SEND NO MONEY, only your name and address. I will rush you the complete plan for your success by return mail. Everything sent you now is FREE and postpaid. Write today. PACIFIC TRAINING SCHOOL, DEPT. R-553, 11029 S. Vermont, Los Angeles 44, Calif.

Edlie for TOP VALUES

JUST OUT! Newest & Best "Fix-It-Yourself" Aid Edlie's E-Z TV REPAIR GUIDE

The only Fix-it-Yourself guide made expressly for YOUR TV set!

Now you can save costly TV repairs with this new, simplified method which includes all necessary data for just YOUR set. No confusing, unimportant information applicable to hundreds of different makes. Simplifies detection of faulty tubes in your TV receiver quickly, accurately.

It's a terrific idea—it's a terrific guide! Order today and have your set back in perfect condition at once. Be sure to send us make and model of your TV set when ordering.

only
50c

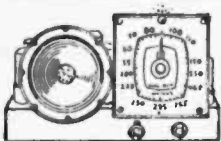

5-TUBE AC/DC SUPERHET KIT

KIT: Includes all top quality components required to construct this latest design, highly sensitive 5-tube AC/DC superheterodyne broadcast receiver. Complete with black, glistening bakelite cabinet (excludes wire solder).

Kit of 5 tubes: 12AT6, 2/12BA6, 12BE6, 35W4 & 50B5 **3.25** less tubes **\$7.95**

6-TUBE RADIO KIT

KIT: A great value in a low-priced radio kit designed for high sensitivity and good tone qualities. Easily constructed circuit. Complete with chassis, all parts, hardware, PM speaker (except wire & solder).



Kit of 6 tubes: 25L6, 25Z6, 6SQ7, 6SA7 & 6SK7 (2) **3.25** less tubes **\$6.95**

Write today for FREE Catalog. All mds. shipped F.O.B. New York City; prices subject to change without notice. Include 20% deposit with C.O.D.'s.

154 **EDLIE ELECTRONICS** New York 6,
Greenwich St. D1. 9-3143 N. Y.

place. The step in the cabin side is merely a piece of aluminum inserted into a slot cut with a razor blade.

The 12 hose outlets are made from brass tubing as detailed in Fig. 17 and cemented to the cabin as indicated. The 1/2-in. diameter brass bell is suspended beneath the front visor with a pin. The air horn and searchlight have a threaded stud so tap them right into the roof. The running lights are cemented to roof. The fire siren is a turned brass cylinder. (See materials list.) A 3/16-in. dowel fastened to the cabin rear wall serves as the mast with a 3/32-in. dowel inserted on the top for holding the silk U. S. flag. Paint the mast with gold PLA. When dry, secure the cabin to the hatch with four 1/2-in. rh screws.

Install the hull-deck accessories next. Cement the stock parts, which include the ventilator cowls, tank fillers, cleats, and bitts in place (Fig. 17). Make up the hand-winch and attach brass chain to it and both anchors. Fasten to the front hatch with two wood screws. The hose reels on the full size craft each hold 1000 ft. of hose and are shown in miniature detail (Fig. 19). The drums can rotate but not the turntables. Cement them to hatches as shown. Make the bow and stern rails of 1/8-in. diameter steel wire and cement them in holes drilled in the deck.

Make up 14 stanchions (Fig. 17) and cement in drilled holes in the deck. Then run a multi-strand flexible wire through the stanchion holes for the side railing and solder this wire to the bow and stern rail. The water monitors are shown in detail (Fig. 19) if you wish to turn them out on a lathe, or they may be purchased (see materials list, special parts). The size of the hole in the nozzle determines the distance the water will shoot. Water forced through a 1/32-in. hole will travel 10 ft. or more while a 3/32-in. hole, although it causes a heavier stream, will only shoot the water 3 ft. In either case, connect the monitors to the pump as shown in Fig. 15 and mount in position through the decks.

At last you are ready for tuning the receiver. The instructions included with the Telecommander will show you how to do this properly. With both switches "ON" at the R-C panel and the ammeter plugged into the 2-in. socket you should read 2.8 steady current and when both buttons are pressed on the transmitter, the current, on receipt of signal, should be .4 or .5. Adjustments are made at the primary and secondary for this. When all is tuned and escapement clicks with each beep signal, you are ready for launching your remote-controlled miniature fireboat.

Now that your *Little Squirt* is completed, you should hold a proper launching ceremony, during which you can show the assembled guests what a big little squirt you built.—END

● Craft Prints in enlarged size for building Little Squirt fireboats are available at \$1.50 each. Order by print number, enclosing remittance (no C.O.D.'s) from Craft Print Dept., SCIENCE AND MECHANICS, 450 East Ohio Street, Chicago 11, Illinois.

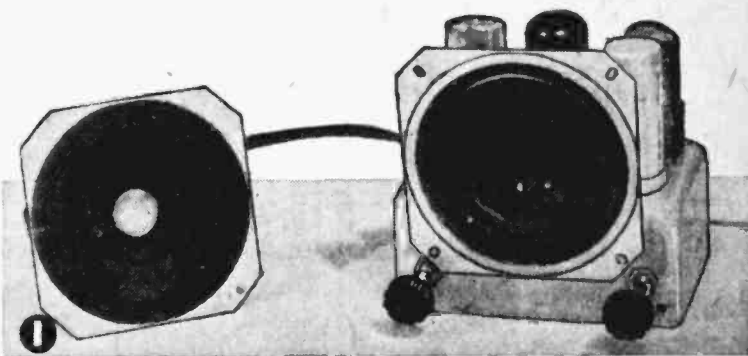
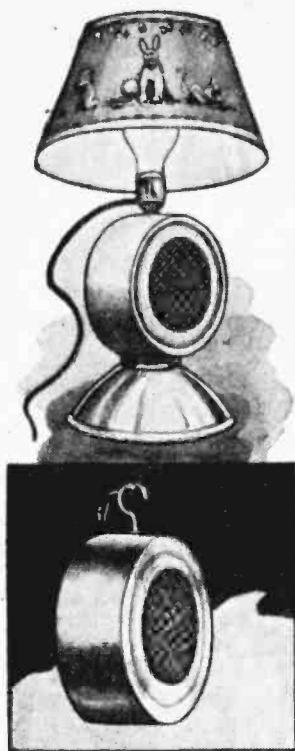

Popular Multi-Com

Use this simple, highly efficient instrument as an electronic "baby-sitter" or 2-way phone

MATERIALS LIST—MULTI-COM

Capacitors

- 2 .005 mfd. (200-600 D.C. w.v.) paper or plastic type
- 1 40-40 mfd., 150 v. electrolytic (20-20 or 30-30 mfd. of same or higher voltage rating may be substituted.) Any aluminum can type: Aerovox, C.D, Sprague, Mallory, etc.
- 2 470K (470,000) ohms, ½ watt resistors
- 1 4.7 megohm, ½ watt resistor
- 1 8200 ohm, ½ watt resistor
- 1 100 or 150 ohm, 1 watt resistor
- 1 150 ohm, 10 watt wire-wound IRC type AB best
- 1 ½ meg. miniature volume control (Mallory Midgetrol No. U-48) and SPST attachable switch (US-26)

Miscellaneous

- 3 octal sockets; wafer or molded type
- 2 midget output transformers; 50L6 type with 2000 or 2500 ohm primaries & 4 ohm secondaries
- 2 midget PM speakers (4 or 5 in. size) with 4 ohm voice coils
- 3 tubes: 1-12SL7GT; 1-50L6GT; 1-35Z5GT or 1-35Z4GT (set wired to permit direct interchange of either type)
- 1 2-pole, 2-position selector switch; Mallory #3222J
- 2 Bakelite knobs; set-screw type for ¼ in. shafts
- 1 line cord and plug (rubber or plastic)
- 1 2-post terminal strip, Jones, JFD, etc.
- 1 aluminum box or refrigerator dish, 5¼ x 3½ x 2¼ in. or larger
- 1 suitable intercom cabinet, homemade or commercial
- 1 PM speaker housing, homemade or commercial
- Nuts, bolts, solder, hook-up wire, and 300 ohm television lead-in wire, or intercom wire

FEW electronic devices provide as many and varied uses as this "Multi-Com." The device is so sensitive that you can literally "hear a pin drop" 100 ft. away. Even a faint baby cry is amplified ten-fold. Although it is discussed here primarily as a two-way phone or an electronic "baby-sitter," it can, with modifications, serve as a very sensitive detector-phone, as a transmitter for talking over a light beam, as a neat, power-line operated hearing aid, or as a home recorder and playback amplifier. These uses will be taken up in future articles if enough readers request them.

The Multi-Com measures 5¼ in. long x 3½ in. wide x 5¼ in. high overall and weighs only 1¾ lbs. (Fig. 1). All components are standard and will be found in any radio supply store, except the aluminum chassis. This can be a blank aircraft aluminum junction box obtained from a surplus dealer, or it can be formed from a sheet of aluminum or you can use a covered refrigerator dish from the hardware or department store in a size close to the original 5¼ x 3½ x 2¼ in. aircraft box. The pictorial wiring dia-

gram (Fig. 2) is arranged so that you may successfully wire the Multi-Com on whatever shape or size chassis you find convenient.

Two 4-in. PM radio speakers serve double-duty as microphone and speaker. You talk and listen from the one unit by flicking the "talk-listen" switch on the amplifier or master control. Usually the amplifier switch is set to receive sound from the remote speaker which functions as a mike. To answer the caller, the person at the other end (master station) turns the selector switch and replies. The master unit speaker thus becomes the mike and the remote PM func-

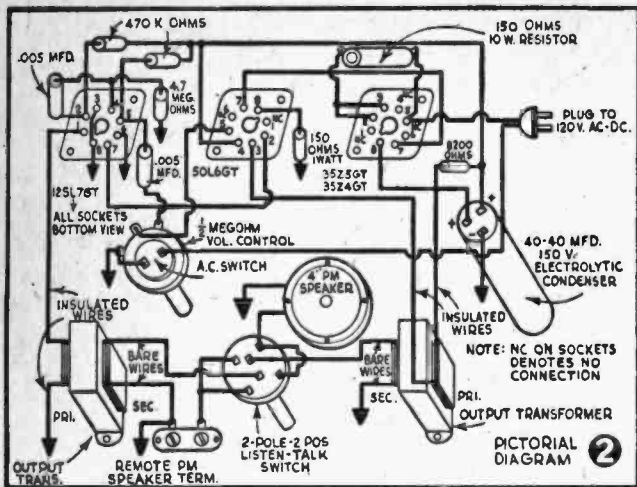

chassis "alive." This is common practice in ac-dc radios enclosed in plastic or wood boxes where the chassis is insulated against possible contact with a radiator, or other metallic objects apt to be grounded. If the line cord plug is inserted in the receptacle, its polarity opposed to ground, a full 110 volt charge will travel between any grounded object and Multi-Com chassis. If, as in the original unit, a plastic or wood "inter-com" cabinet is purchased from a radio supply store, this presents no dangerous situation. However, if you use the Multi-Com just as shown, or in a metal box, the following modifications are essential.

Connect all leads indicated by

tions as a regular speaker. The switch returned to remote position allows the first person to reply.

A second speaker can be attached to the remote line which leads to the basement, establishing contact on 3 floors. This single application may be applied to 2-way loud-phone service between home and garage, dairy barn, office or factory. Using inexpensive, weatherproof 300 ohm television lead-in wire, the Multi-Com will perform well up to 1/4 mile. A volume control on the master unit, which also incorporates the on-off switch, permits suitable volume adjustment.

A glance at the top view photograph (Fig. 3) shows the placement of tubes, speaker, electrolytic capacitor and one of the 50L6 type output

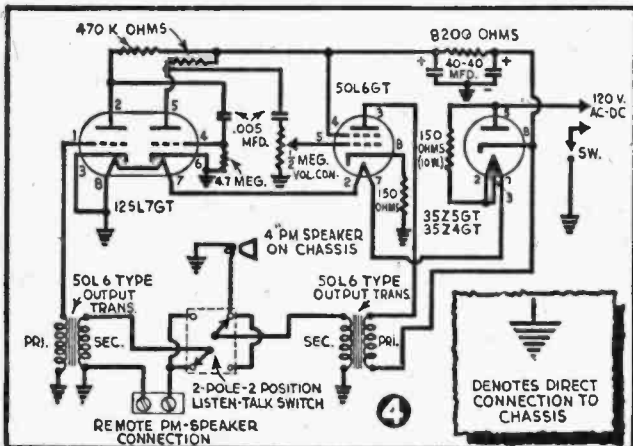
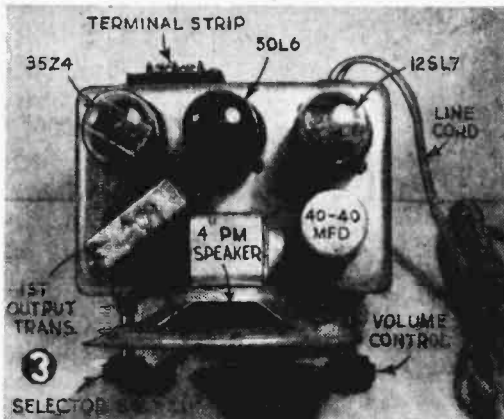

ground symbol together with insulated hook-up wire. At any point along this grounded circuit attach one end of a .1 mfd. paper capacitor with remaining lead attached to chassis. Also, if the 40-40 mfd. electrolytic condenser is marked "can common" you must mount this unit on the Bakelite plate provided with the condenser, so it, too, is insulated from chassis.

Most PM speakers are provided with a mounting bracket containing either screw holes or lugs on which the output transformer would normally be mounted. In the case of the Multi-Com this bracket provides a means of mounting the speaker to the chassis. Mount one 50L6 type

output transformer on top of the chassis and one beneath (Fig. 5) to provide ample shielding and prevent coupling which might produce

"feedback"—howl caused by oscillation. Feedback will also occur if both master and remote speakers are located in same room with volume control turned on full. This doesn't happen when

output transformer on top of the chassis and one beneath (Fig. 5) to provide ample shielding and prevent coupling which might produce "feedback"—howl caused by oscillation. Feedback will also occur if both master and remote speakers are located in same room with volume control turned on full. This doesn't happen when

units are remote from each other as normally intended.

Because aluminum is easy to work with, you can make all necessary socket and mounting holes with hand tools. Start the 1 in. socket holes and $\frac{3}{8}$ in. potentiometer, selector switch, and grommet holes with a $\frac{1}{16}$ in. bit, and hand ("egg beater") drill. To cut 1 in. holes, use a dime store can opener of the type having a hook on the end, and a sliding cutter on the shaft. Set the cutter so it is $\frac{1}{2}$ in. from the hook, and clamp it fast to can opener shaft with a midjet C-clamp.

Force the hook end into the $\frac{1}{16}$ in. center hole and turn the can opener around and around to deeply score the aluminum. A cut having a depth half the thickness of the aluminum is usually sufficient. With "duckbill" tinsnips, cut a triangular opening from the center to scored

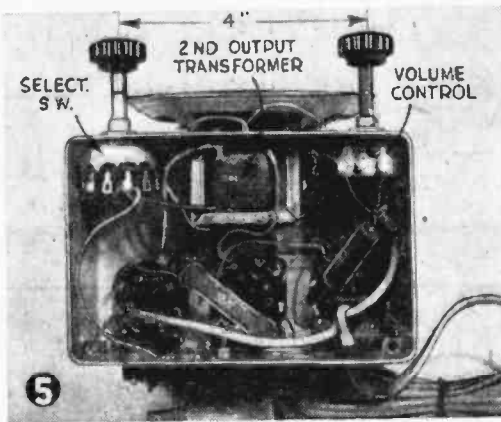

Bottom of Multi-Com shows few parts involved. Note position of second output transformer on chassis apron. Selector switch and volume control, mounted 4 in. apart, and $\frac{1}{8}$ in. from bottom edge of chassis, provide proper spacing to fit standard inter-com boxes.

edge, and bend back and forth. It will break off clean along the round scored circle. Cut another triangle as before, break off, and repeat until hole is complete.

A little practice will enable you to cut any size hole up to about 10 in. dia. with this method. Of course, it is not suited to any metal other than light tinplate or aluminum. For smaller holes ($\frac{3}{8}$ to $\frac{1}{2}$ in.), use a $\frac{3}{4}$ in. pipe reamer. Drill a $\frac{1}{4}$ in. hole to start the reamer, then enlarge the opening, using an ordinary bit brace to hold the reamer. Remove burrs remaining with a small rat-tail or $\frac{1}{2}$ round file.

The housing for the remote PM speaker may be any of the usual small wooden cabinets sold for the purpose. However, you may want to use one of the two novel, inexpensive home-made housings described below. One type incorporates the speaker into a nursery lamp (Fig. 6), while the other type is provided with a hook (Fig. 7). Both types are built around an ordinary 1 lb. coffee tin, but a 4 in. PM unit must be used on

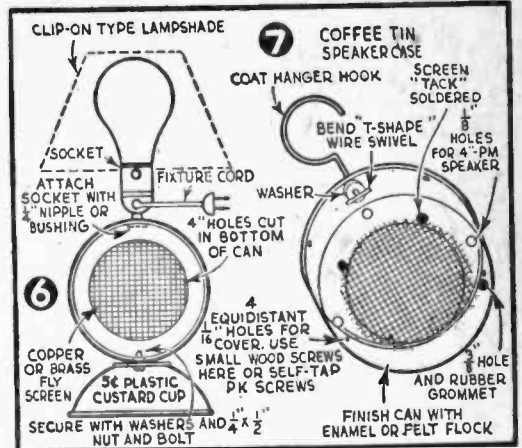

the remote end rather than the 5 in. size speaker. If 4 in. PM has a round frame, it will fit snugly into can. If speaker has a square frame, snip about $\frac{1}{16}$ in. off each mounting corner.

Using the hole-cutting scheme already described, or a "fly-cutter," make a 4 in. opening in the bottom of the coffee tin. Drill four $\frac{1}{8}$ in. mounting holes for the speaker and a $\frac{3}{8}$ in. hole in the side of the can for the cord. Drill a $\frac{1}{8}$ in. hole in side of can directly opposite the $\frac{3}{8}$ in. hole. Replace cover on tin, and drill 4 equidistant $\frac{1}{16}$ in. holes around lid's edge, passing through both lid and can.

Cut a $4\frac{1}{2}$ in. circle of brass fly screening and solder it at several points inside can over the 4 in. circular opening. Now give can a coat of 4 hr. enamel in any desired color. Or, if you have some felt flock, place it in a flour sifter and sprinkle the wet paint until a good flock deposit has been obtained. When paint has set, brush off excess flock and a very attractive speaker case is the result.

Insert the hook portion of an ordinary coat-hanger into the $\frac{1}{8}$ in. hole in side of can. Slip a length of auto windshield wiper hose over hook to make it mar-proof so speaker may be hung on a crib rail, chair, etc.

To combine the speaker with a night lamp, proceed as above. However, paint side of can in bright red, with front and back in white enamel. When dry, decorate sides of can with criss-cross strips of decorative Scotch tape in candy stripe or any of the other attractive patterns, to make the coffee tin resemble a miniature drum.

Having provided an extra $\frac{3}{8}$ in. hole in top center of can, fit a regular lamp socket with standard mounting bushing sold for this purpose by dime stores and electric supply stores. Add an attractive shade in a nursery design, or decorate a plain shade of paper parchment with decal decorations. For the lamp base, invert a colored plastic custard cup and attach to bottom of can with a $\frac{1}{4}$ x $\frac{1}{2}$ in. steel bolt and 2 washers—one in can, one in bottom of cup.



Radio Symbols

RESISTORS

| | |
|-----------------------------------------------------------------------|-------------------------------------------------------|
| <p>FIXED RESISTOR CARBON COMPOSITION OR WIRE-WOUND</p> | <p>COMPOSITION WIRE WOUND</p> |
| <p>ADJ. OR TAP TYPE</p> | <p>ADJ. WIRE</p> |
| <p>VOLUME CONTROL OR WIRE POTENTIOMETER</p> | <p>VOLUME CONTROL</p> <p>WIRE WOUND</p> |

COILS (INDUCTANCE, ETC.)

| | |
|---------------------------------------------------------------------|------------------------------------------|
| <p>R.F. CHOKE</p> | <p>STATIONARY TYPE (AIR CORE)</p> |
| <p>PLATE WINDING OR ANT. COUPLING</p> | <p>PLUG-IN TYPE (AIR CORE)</p> |
| <p>GRID WINDING ANT., R.F. & REGENERATIVE INDUCTANCE</p> | |
| <p>LOUDSPEAKER</p> | <p>AIR LOOP</p> |

CAPACITORS (CONDENSERS)

| | | |
|---------------------------------|---------------------------------|-----------------------------|
| <p>VARIABLE</p> | <p>SINGLE</p> | <p>GANG</p> |
| <p>TRIMMER OR PADDER</p> | <p>TRIMMER OR PADDER</p> | |
| <p>FIXED</p> | <p>PAPER</p> | <p>CAN</p> |
| <p>PAPER OR MICA</p> | <p>CERAMIC</p> | <p>ELECTROLYTICS</p> |
| <p>MULTI-SECTION</p> | <p>MICA</p> | <p>TUBULAR</p> |

| | |
|----------------------------|------------------------------|
| <p>LOOP-ANTENNA</p> | <p>MIDGET-FERRITE</p> |
|----------------------------|------------------------------|

MISCELLANEOUS

| | | |
|--------------------------------------------------|------------------------------|--------------------------|
| <p>NUMBERS INDICATE SOCKET CONNECTION</p> | <p>MINIATURE TUBE</p> | <p>OCTAL TUBE</p> |
|--------------------------------------------------|------------------------------|--------------------------|

| | |
|-------------------------------------|----------------------------------|
| <p>SWITCHES SELECTOR</p> | <p>SINGLE SELECTOR</p> |
| <p>TOGGLE, ETC. OR "TAP"</p> | <p>TOGGLE OR MULTIPLE</p> |

COIL & TRANSFORMERS

| | |
|-----------------------------------------------------------------------------------------|-------------------------------------------|
| <p>AUDIO</p> | <p>A.C. POWER</p> |
| <p>PLATE GRID</p> | <p>R.F., ANT. & OSC. TYPES</p> |
| <p>IRON CORE I.F. SHOWS ARROW SYMBOL. CAPACITOR TYPES SHOW BUILT-IN TRIMMERS</p> | <p>I.F. TRANS.</p> |
| <p>IRON CORE CHOKE</p> | <p>FILTER CHOKE</p> |

| | |
|----------------------------------|---------------------------------------|
| <p>CRYSTAL DIODE</p> | <p>DRY DISC RECTIFIER</p> |
| <p>BROADCAST ANTENNAS</p> | <p>CRYSTAL DIODE RECTIFIER</p> |

| | |
|----------------------|---------------------------------------|
| <p>TV, FM</p> | <p>7 PIN MINI-TUBE SOCKET</p> |
| <p>GROUND</p> | <p>8 PIN OCTAL TUBE SOCKET</p> |

IMPORTANT

All tube sockets are numbered (clockwise) on bottom side starting at wide space on 7-pin tubes, and from keyway on octals and loktals. Socket No.'s read in consecutive order left to right from 1 to 7; 1 to 8, or 1 to 9 depending upon number of tube elements.

Useful Tables and Formulas

Compiled by Thomas A. Blanchard

STANDARD RESISTOR VALUES

• Table A, below, lists all *carbon type* resistors manufactured in the United States according to RTMA (Radio-Television Manufacturers Association) and JAN (Joint Army-Navy) Standards. The bold figures show the 10% accuracy values that are becoming the preferred electronic standard. For example, a circuit may call for a resistor of 50,000 ohms. However, noting chart, the nearest standard 10% value today is 47,000 ohms.

Except in cases where a very low ohms value is called for, any resistance under 500 ohms, it is usually safe to use the nearest value shown in bold face type in Table A.

TABLE A—STANDARD RESISTANCE VALUES

| All values in OHMS | | | | | | Identical | | | MEG OHMS | | |
|--------------------|----|-----|-------|--------|---------|-----------|-----|------|----------|--|--|
| 1.0 | 10 | 100 | 1,000 | 10,000 | 100,000 | 0.1 | 1.0 | 10.0 | | | |
| 1.1 | 11 | 110 | 1,100 | 11,000 | 110,000 | 0.11 | 1.1 | 11.0 | | | |
| 1.2 | 12 | 120 | 1,200 | 12,000 | 120,000 | 0.12 | 1.2 | 12.0 | | | |
| 1.3 | 13 | 130 | 1,300 | 13,000 | 130,000 | 0.13 | 1.3 | 13.0 | | | |
| 1.5 | 15 | 150 | 1,500 | 15,000 | 150,000 | 0.15 | 1.5 | 15.0 | | | |
| 1.6 | 16 | 160 | 1,600 | 16,000 | 160,000 | 0.16 | 1.6 | 16.0 | | | |
| 1.8 | 18 | 180 | 1,800 | 18,000 | 180,000 | 0.18 | 1.8 | 18.0 | | | |
| 2.0 | 20 | 200 | 2,000 | 20,000 | 200,000 | 0.2 | 2.0 | 20.0 | | | |
| 2.2 | 22 | 220 | 2,200 | 22,000 | 220,000 | 0.22 | 2.2 | 22.0 | | | |
| 2.4 | 24 | 240 | 2,400 | 24,000 | 240,000 | 0.24 | 2.4 | 24.0 | | | |
| 2.7 | 27 | 270 | 2,700 | 27,000 | 270,000 | 0.27 | 2.7 | 27.0 | | | |
| 3.0 | 30 | 300 | 3,000 | 30,000 | 300,000 | 0.3 | 3.0 | 30.0 | | | |
| 3.3 | 33 | 330 | 3,300 | 33,000 | 330,000 | 0.33 | 3.3 | 33.0 | | | |
| 3.6 | 36 | 360 | 3,600 | 36,000 | 360,000 | 0.36 | 3.6 | 36.0 | | | |
| 3.9 | 39 | 390 | 3,900 | 39,000 | 390,000 | 0.39 | 3.9 | 39.0 | | | |
| 4.3 | 43 | 430 | 4,300 | 43,000 | 430,000 | 0.43 | 4.3 | 43.0 | | | |
| 4.7 | 47 | 470 | 4,700 | 47,000 | 470,000 | 0.47 | 4.7 | 47.0 | | | |
| 5.1 | 51 | 510 | 5,100 | 51,000 | 510,000 | 0.51 | 5.1 | 51.0 | | | |
| 5.6 | 56 | 560 | 5,600 | 56,000 | 560,000 | 0.56 | 5.6 | 56.0 | | | |
| 6.2 | 62 | 620 | 6,200 | 62,000 | 620,000 | 0.62 | 6.2 | 62.0 | | | |
| 6.8 | 68 | 680 | 6,800 | 68,000 | 680,000 | 0.68 | 6.8 | 68.0 | | | |
| 7.5 | 75 | 750 | 7,500 | 75,000 | 750,000 | 0.75 | 7.5 | 75.0 | | | |
| 8.2 | 82 | 820 | 8,200 | 82,000 | 820,000 | 0.82 | 8.2 | 82.0 | | | |
| 9.1 | 91 | 910 | 9,100 | 91,000 | 910,000 | 0.91 | 9.1 | 91.0 | | | |

Note: Values below one ohm are available for precise instrument or laboratory work. They are not ordinarily needed by the radio or TV experimenter.

10% accuracy resistors are less costly and can be used for most applications. All values listed may not be available from all manufacturers or radio supply houses.

It will be noted that resistors are standardized in *units, tens, hundreds, thousands* . . . reading across table. This simplifies reading of color codes. While standard values stop at 22 megohms, IRC and certain other resistor makers supply values up to 200 megohms for laboratory use. Special resistors may cost 100 times a standard value due to technically skilled labor required in calibration as against production-line labor.

RESISTORS IN MULTIPLE

• *Series.* Any number of resistors of identical wattage may be connected in series to obtain a desired resistance value. If wattage ratings are mixed, the total resistance will handle as much as the lowest wattage resistor in the "string."

FORMULA: $R_1 + R_2 + R_3 = \text{RESISTANCE TOTAL}$
 EXAMPLE: $15000 + 47000 + 22000 = 84000 \text{ OHMS}$



Parallel. Identical resistors in parallel increase the wattage rating of the total resistance. At the same time the total number of resistors becomes the divisor for the unit combination.

(Using three 4700-ohm, 1-watt units, for example.)

FORMULA: $R = \frac{R_1 \times R_2 \times R_3}{\text{NO. OF RESISTANCES}} = \text{TOTAL RESISTANCE}$

EXAMPLE: $\frac{4700 \times 4700 \times 4700}{3} = 1567 \text{ OHMS}$

FORMULA: $P \times \text{NO. OF RESISTANCES} = \text{TOTAL WATTAGE (POWER)}$
 EXAMPLE: $1 \times 3 = 3 \text{ WATTS}$



Mixed value resistors connected in parallel employ this formula for multiples of two resistors only: (Using a 4700 and 3300 ohm 1-watt resistor, for example.)

FORMULA: $\frac{R_1 \times R_2}{R_1 + R_2} = \text{TOTAL RESISTANCE}$

EXAMPLE: $\frac{4700 \times 3300}{4700 + 3300} = \frac{155100}{8000} = 19.4 \text{ OHMS (APPROX)}$

Mixed resistances in parallel do not (theoretically) double in current carrying capacity (wattage). However, if above 4700 and 3300-ohm resistors were each rated 1-watt, the combination would handle almost two watts. If a large difference exists between two values, total wattage through circuit should not greatly exceed rating of lowest wattage single unit.

For multiple mixed parallel combinations, reduce resistors in pairs with above formula until arriving at final resistance. There are formulas

STANDARD RTMA TRANSFORMERS CODE

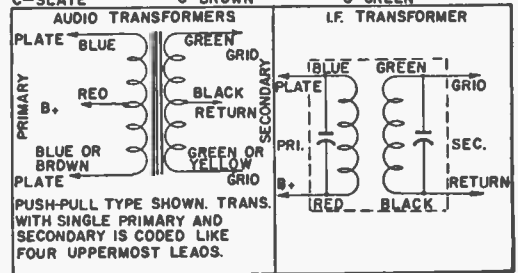
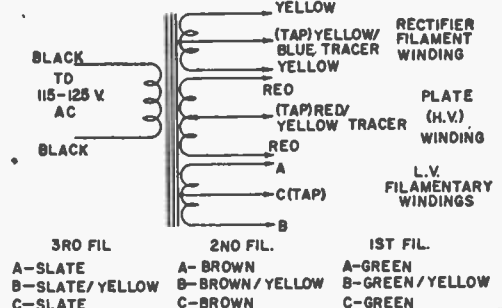

for multiple mixed resistor combinations, but they are much more complicated than simple reduction.

ual). Subtract the resulting figure from your power line voltage. Now divide the tube current into the voltage difference. The answer will be the value of the voltage dropping resistor in ohms. For example:

COLOR CODE CHART—FOR RESISTORS AND CAPACITORS

| Color Dot A (mmf.) Color Band A (ohms) | Color Dot B (mmf.) Color Band B (ohms) | Color Dot C (mmf.) Color Band C (ohms) |
|-------------------------------------------|-------------------------------------------|-------------------------------------------|
| Black.....0 | Black.....0 | Black.....0 |
| Brown.....1 | Brown.....1 | Brown.....Add 1 zero |
| Red.....2 | Red.....2 | Red.....Add 2 zeros |
| Orange.....3 | Orange.....3 | Orange.....Add 3 zeros |
| Yellow.....4 | Yellow.....4 | Yellow.....Add 4 zeros |
| Green.....5 | Green.....5 | Green.....Add 5 zeros |
| Blue.....6 | Blue.....6 | Blue.....Add 6 zeros |
| Violet.....7 | Violet.....7 | Violet.....Add 7 zeros |
| Gray.....8 | Gray.....8 | Gray.....Add 8 zeros |
| White.....9 | White.....9 | White.....Add 9 zeros |

Example:
Band A is Yellow
Band B is Violet
Band C is Orange
Resistor will be 47,000 ohms.

Example:
Dot A is Red
Dot B is Green
Dot C is Brown
Capacitor is 250 mmf.

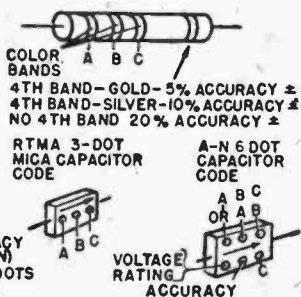

TABLE B—DECIMAL EQUIVALENTS

| | | | |
|-------------|-------------|-------------|-------------|
| 1/64 .0156 | 1/4 .2500 | 1/2 .5000 | 3/4 .7500 |
| 1/32 .0312 | 17/64 .2656 | 33/64 .5156 | 49/64 .7656 |
| 3/64 .0469 | 9/32 .2812 | 17/32 .5312 | 25/32 .7812 |
| | 19/64 .2969 | 35/64 .5469 | 51/64 .7969 |
| 1/16 .0625 | 5/16 .3125 | 9/16 .5625 | 13/16 .8125 |
| 5/64 .0781 | 21/64 .3281 | 37/64 .5781 | 53/64 .8281 |
| 3/32 .0938 | 11/32 .3438 | 19/32 .5938 | 27/32 .8437 |
| 7/64 .1094 | 23/64 .3594 | 39/64 .6094 | 55/64 .8594 |
| 1/8 .1250 | 3/8 .3750 | 5/8 .6250 | 7/8 .8750 |
| 9/64 .1406 | 25/64 .3906 | 41/64 .6406 | 57/64 .8906 |
| 5/32 .1562 | 13/32 .4062 | 21/32 .6562 | 29/32 .9062 |
| 11/64 .1719 | 27/64 .4219 | 43/64 .6719 | 59/64 .9219 |
| 3/16 .1875 | 7/16 .4375 | 11/16 .6875 | 15/16 .9375 |
| 13/64 .2031 | 29/64 .4531 | 45/64 .7031 | 61/64 .9531 |
| 7/32 .2188 | 15/32 .4688 | 23/32 .7188 | 31/32 .9688 |
| 15/64 .2344 | 31/64 .4844 | 47/64 .7344 | 63/64 .9844 |

TABLE C—METRIC LENGTHS TO INCHES

| | |
|------------------------------------|----------------|
| 2.54 Centimeters = 1 inch | |
| 1 Millimeter (unlt) mm | = .03937 inch |
| 10 Millimeters = 1 Centimeter (cm) | = .3937 inch |
| 10 Centimeters = 1 Decimeter | = 3.937 inches |
| 10 Decimeters = 1 Meter (m) | = 39.37 inches |

COMPUTING VOLTAGE-DROPPING RESISTOR FOR SERIES WIRED TUBES

• Small ac-dc radios are operated without use of a step-down filament transformer by wiring all tube filaments (heaters) in series. Tubes in a modern 5-tube set have individual filaments which total 121 volts, requiring no voltage-drop.

Sets with 4 or less tubes may require a resistor to make up the difference between their total and line voltage. Most miniature tubes and GT types draw .3 amp. if 6-volt filament type; or .150 amp. if 12-volt filament type.

To calculate voltage drop, add up total voltage of tubes in string (all must have same current rating as determined by checking in a tube man-

Line voltage 120 volts
Three 12 v., .150 amp. tubes total 36 volts
Voltage drop 84

R = Resistance in ohms
E = voltage in volts
I = current in amperes

$$R = \frac{E}{I} = \frac{84}{.150} = 560\text{-ohm resistor required}$$

To determine wattage rating use formula $W = I^2 R$ or $.150 \times .150 \times 560 = 12.60$ watts.

Since a 560-ohm, 12.60-watt resistor is not available, select next size: in this case 600 ohms rated at 20 watts.

FINDING THE UNKNOWN

| Volts —E— | Milliamperes (Ma.) —I— | Ohms —R— | Watts —W— |
|---------------|------------------------|-------------------|------------------|
| Known | Known | 1000 x volts | Volts x millamps |
| | | milliamperes | 1000 |
| Known | 1000 x volts | Known | Volts x volts |
| | Ohms | | Ohms |
| Known | 1000 x watts | volts x volts | Known |
| | volts | watts | |
| MA. x Ohms | Known | Known | MA. x MA. x Ohms |
| 1000 | | | 1,000,000 |
| 1000 x watts | Known | 1,000,000 x watts | Known |
| MA. | | MA. x MA. | |
| √ohms x watts | 1000 √watts | Known | Known |

Circuit component requirements are quickly established with this table so long as any two items in columns are known. Then simply read across the proper row for formulas that will provide the unknown information.

OHM'S LAW AND DIRECT CURRENT RELATIONS

(E = IR or Volts = Amperes x Ohms)

(E) VOLTS = IR or $\frac{W}{I}$ or \sqrt{RW} (I) AMPS. = $\frac{E}{R}$ or $\frac{W}{E}$ or $\sqrt{\frac{W}{R}}$
(R) OHMS = $\frac{E}{I}$ or $\frac{E^2}{W}$ (W) WATTS = EI or I²R or $\frac{E^2}{R}$

TABLE D—CONVERTING ELECTRONIC UNITS OF MEASURE

| | | |
|-------------------|---------------------|---------------------|
| Amperes | × 1,000,000 | = Microamperes |
| Amperes | × 1,000 | = Milliamperes |
| Cycles | × .000,001 | = Megacycles |
| Cycles | × .001 | = Kilocycles |
| Farads | × 1,000,000,000,000 | = Micro-microfarads |
| Farads | × 1,000,000 | = Microfarads |
| Henries | × 1,000,000 | = Microhenries |
| Henries | × 1,000 | = Millihenries |
| Kilocycles | × 1,000 | = Cycles |
| Kilovolts | × 1,000 | = Volts |
| Kilowatts | × 1,000 | = Watts |
| Megacycles | × 1,000,000 | = Cycles |
| Microfarads | × .000,001 | = Farads |
| Microfarads | × 1,000,000 | = Micro-microfarads |
| Microhenries | × .000,001 | = Henries |
| Microvolts | × .000,001 | = Volts |
| Micro-microfarads | × .000,000,000,001 | = Farads |
| Milliamperes | × .001 | = Amperes |
| Millihenries | × .001 | = Henries |
| Millivolts | × .001 | = Volts |
| Ohms | × .000,001 | = Megohms |
| Ohms | × 1,000 | = Miliohms |
| Volts | × 1,000,000 | = Microvolts |
| Volts | × 1,000 | = Millivolts |
| Watts | × 1,000 | = Milliwatts |
| Watts | × .001 | = Kilowatts |

This table is extremely versatile in that it may be used forward and backward. For Example: amperes x 1,000,000 = microamperes. Or 0.25

amp. $\times 1,000,000 = 250,000$ microamperes. Reading the table from right to left, note that a micro-ampere is a millionth part of an ampere; a milli-ampere is a thousandth part of an ampere.

The center "multiplier" column is expressed both in whole numbers and decimals. This is done for mathematical simplicity.

When reading a decimal "multiplier" from right to left, it is read as a whole number. For example: Watts $\times .001 =$ Kilowatts. Or 10 watts $\times .001 = .01$ (1/100th part of a kilowatt.) Now reading right to left, Kilowatt equals 1000 watts. The decimal .001 (1/1000th) is read as a whole number, or one thousand.

TABLE E—ELECTRONIC & ELECTRICAL ABBREVIATIONS

| | |
|-------------|--------------------------------------------------------------------------------------------------------------------------|
| A.C., a-c | Alternating Current |
| A.F. | Audio Frequency |
| AM | Amplitude Modulation. Method of transmission used by standard long and short-wave stations; also for sending TV pictures |
| A.V.C. | Automatic Volume Control |
| C (cp.) | Capacitance in farads; microfarads, or micro-microfarads |
| c.p.s. | Cycles per second |
| db | Decibel. A unit of sound measurement |
| D.C., d-c | Direct Current |
| FM | Frequency Modulation. Method of sound transmission used by high-frequency broadcasters (including TV sound) |
| E. e | Symbol denoting voltage |
| f | Frequency—kilocycles or megacycles |
| emf, e | Electromotive force |
| H.F. | High-frequency as used for standard shortwave, FM and TV sound and picture transmission. |
| H.V. | High-voltage (usually with regard to TV circuits) |
| Hy, h | Henry, unit for measuring coil inductance |
| I | Electrical symbol for current (amperes, milliamperes, microamperes) |
| I.F., i.f. | Intermediate Frequency (or transformers as employed in superheterodyne circuits) |
| K (M) | Kilo from the Greek meaning one thousand. M also a prefix for one thousand, but becoming obsolete |
| L | Electrical symbol for inductance |
| L.V. | Low-voltage (tube filaments and TV voltages under 360v.) |
| ma | Milliamperes; 1/1000th of an ampere |
| Meg, MΩ | One megohm (1-megohm = one million ohms) |
| mfd, μfd | Microfarad |
| mmf. | Micro-microfarad |
| Mil | One-thousandth part. Used as prefix in voltage and current. Also a measurement of wire diameters |
| mu | Amplification factor of vacuum tubes |
| R | Symbol for electrical resistance (ohms) |
| R.F. | Radio Frequency |
| RMS, r.m.s. | Root mean square as employed in alternating current calculation |
| SG (gs) | The high potential valve element in a vacuum tube; often called the screen grid |
| SW (sw) | Switch or shortwave |
| TRF, t.r.f. | Tuned Radio Frequency. Often with reference to a low sensitivity-high fidelity type radio circuit |
| UHF | Ultra-High Frequency |
| VHF | Very-High Frequency |
| wl, λ | Wavelength |
| X | Electrical symbol for reactance (Opposing force to e-e) |
| Z | Electrical symbol for Impedance (Total e-e opposition) |

GREEK SYMBOLS

| | |
|---|-------------------------------|
| Ω | Ohms (from omega) "O" |
| λ | Wavelength (from lambda) "L" |
| μ | Mu or micro- (Greek letter M) |
| π | Pi or 3.14 (Greek letter P) |

Greek Alpha (A); Beta (B), Gamma (C) denote type of radio-active waves.

BUILD 15 RADIOS

AT HOME ONLY
With the New Improved 1955 Progressive Radio "EDU-KIT" **\$19.95** COMPLETE

NOW INCLUDES
HIGH FIDELITY, SIGNAL TRACER, CODE OSCILLATOR

- Attractively Gift Packed
- Free Soldering Iron
- Absolutely No Knowledge of Radio Necessary
- No Additional Parts Needed
- Excellent Background For Television
- 10-Day Money-Back Guarantee
- School Inquiries Invited
- Sold in 79 Countries



WHAT THE PROGRESSIVE RADIO "EDU-KIT" OFFERS YOU

The "Edu-Kit" offers you a Home Radio Technician Course at a rock-bottom price. You will learn how to identify Radio Symbols and Diagrams; how to build radios using regular radio schematics; how to wire and solder in a professional manner. You will learn how to operate Receivers, Transmitters, and Audio Amplifiers. You will learn how to service and trouble-shoot radios. You will learn code. You will receive training for F.C.C. license. In brief, you will receive a practical basic education in Radio, worth many times the small price you pay.

THE KIT FOR EVERYONE

It is not necessary that you have even the slightest background in science or radio. The "Edu-Kit" is used by young and old; by radio schools and clubs; by Armed Forces personnel and Veterans for training and rehabilitation. No instructor is required. Instructions are complete, simple and clear. You cannot make a mistake.

PROGRESSIVE TEACHING METHOD

The "Edu-Kit" uses the principle of "Learn by Doing." Therefore you will build radios, perform jobs, and conduct experiments to illustrate the principles which you learn. You begin by learning the function and theory of each of the radio parts. Then you build a simple radio. Gradually, in a progressive manner, you will find yourself constructing more advanced multi-tube radio sets and doing work like a professional Radio Technician. The "Edu-Kit" Instruction Book sets the exceedingly clear in their explanations, illustrations and diagrams. These sets operate on 105-125 V. AC/DC. Adapter for 210-250 V. AC/DC available.

The Progressive Radio "EDU-KIT" Is Complete

You will receive every part necessary to build fifteen different radio sets. Our kits contain tubes, tube sockets, chassis, variable condensers, electrolytic condensers, mica condensers, paper condensers, resistors, line cords, selenium rectifiers, tie strips, coils, hardware, tubing, Instruction Manuals, etc. A soldering iron is included, as well as an Electrical and Radio Tester. Complete, easy-to-follow instructions are provided. All parts are guaranteed Brand New, carefully selected and matched. In addition, the "Edu-Kit" now contains lessons for servicing with the Progressive Signal Tracer, F.C.C. Instructions, quizzes, High Fidelity. The "Edu-Kit" is a complete radio course, down to the smallest detail.

TROUBLE-SHOOTING LESSONS

Trouble-shooting and servicing are included. You will be taught to recognize and repair troubles. You will build and learn to operate a professional Signal Tracer. You receive an Electrical and Radio Tester and learn to use it for radio repairs. While you are learning in this practical way, you will be able to do many a repair job for your neighbors and friends and charge fees which will far exceed the cost of the "Edu-Kit." Our Consultation Service will help you with any technical problems which you may have.

FREE EXTRAS

• Electric Radio Tester • Soldering Iron • TV Book • Radio Trouble-Shooting Guide • Consultation Service • Quizzes • F.C.C. Training
PROGRESSIVE "EDU-KITS" INC., 497 Union Av., Brooklyn 11, N.Y.
MAIL TODAY—Order shipped same day received.
10-Day Money-Back Guarantee. INCLUDE ALL FREE EXTRAS.

- RUSH ME the Following—Include All Free Extras:
- "EDU-KIT" Postpaid. I enclose full payment of \$19.95
 - "EDU-KIT" C.O.D.—I will pay \$19.95 plus postage
 - Outside USA: "Edu-Kit" Postpaid. Enclose \$20.95
 - Outside USA: 210-250V. AC/DC Adapter. Enclose \$2.50
 - More details on "EDU-KIT" Free—No obligation
 - FREE Radio-TV Servicing Literature. No obligation

NAME _____
ADDRESS _____

PROGRESSIVE "EDU-KITS" INC.
497 Union Ave. Dept. SMX Brooklyn 11, N. Y.

Precision Electronic Timer

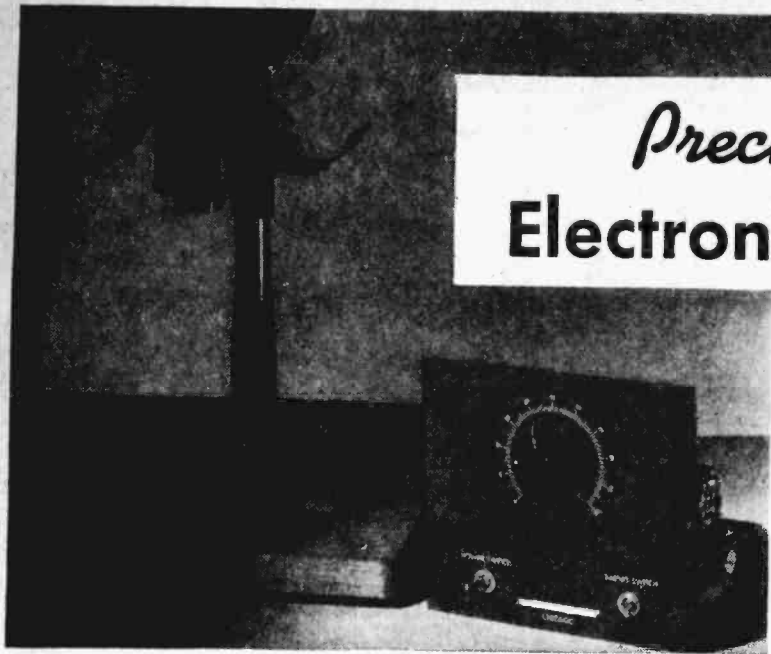

Try this versatile unit for photo printing, experimenting, or making flasher displays.

By MILO A. ADLER

SIMPLICITY, dependability, and the ability to maintain accuracy after calibration were the three main factors considered when designing this electronic timer. The circuit is not complex and the number of components has been kept at a minimum. This timer will give accurate timing intervals in ranges from less than one second to over sixty seconds, regardless of line voltage variations, over the extremely wide range of 90 to 130 volts.

The plate relay used has double-pole double-throw contacts that are independent of the internal circuit of the timer. This versatile switching arrangement enables the builder of this unit to find countless applications for this timer. The experimenter may use the timer to accurately time the "on" or "off" period of an electrical device. The photographer may use it for accurately timing the exposure of photographic prints. Two of these units may be connected together for use in a flasher system where it is desired to regulate the duration of the "on" and "off" period of a window display or sign.

Parts needed may be purchased from radio suppliers by mail without difficulty. Special components are not used and all parts are standard units made by reputable manufacturers. The chassis used for the model shown in the illustration is 6 x 5 x 2 inches, and the panel is 6½

by 5½ inches. The chassis is laid out as shown in the pictorial diagram and illustration. The arrangement of the components is not critical and the only precaution necessary is to be sure the tube guide slots face in the direction shown in the pictorial diagram.

When wiring, either the pictorial or schematic diagram may be used. The pictorial is preferred for it shows the exact placement of wires and parts. Wire the filament circuit before wiring resistors, condensers, etc. Work slowly, checking each

connection as it is made. An extra few minutes spent in careful wiring and thorough checking may save hours of trouble-shooting later. Be sure that the polarity of the electrolytic capacitor

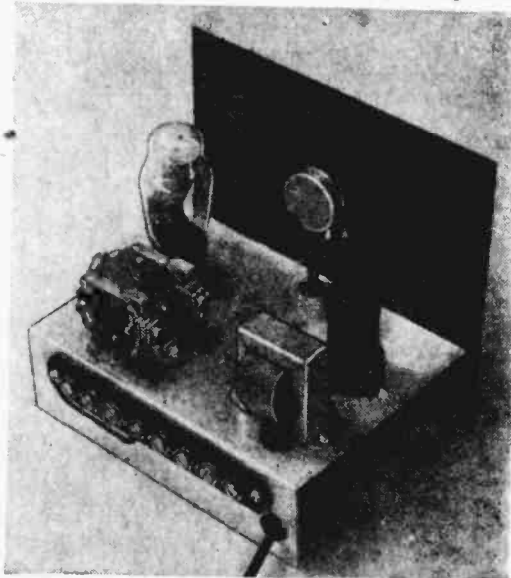

Rear view showing wire jumpers for automatic shutoff.

is observed when wiring it across the relay. The negative side must be connected to the plate of the 2050 tube. The right and left hand terminals of the timing control potentiometer may be determined by viewing the control from the back with the terminals pointing downward.

After the timer has been completely wired and the tubes inserted, the unit is ready for operation. The timer operates on 90 to 130 volts, 50 to 60 cycle ac only. The double-pole double-throw relay, as previously stated, permits the control of a large variety of circuits and of more than one unit at a time. To time the operation of any electrical device not drawing more than 800 watts from a 110 volt line, connect terminals 3 and 4 (or 6 and 7) in series with the device and the current source. Turn the power switch "On" and allow about one minute for the tubes to warm up. To start a timing cycle (the period of time for which the timer is activated), turn the timer switch "On." There will be a slight time lag of approximately one second; then the relay will close and the apparatus will operate until the timing cycle is completed. The timer switch must be left on for the duration of the cycle. If the switch is turned "Off" before the cycle is complete, the timing operation will stop. When the timing cycle is completed, the relay opens and current flowing to the device being operated is stopped. The switch may then be turned off, and the timer will be ready for a new cycle. To time an "Off" period for an electrical device that is normally on, connect terminals 4 and 5 (or 7 and 8) in series with the device and the current source. A remote switch, if desired, can be connected to terminals 1 and

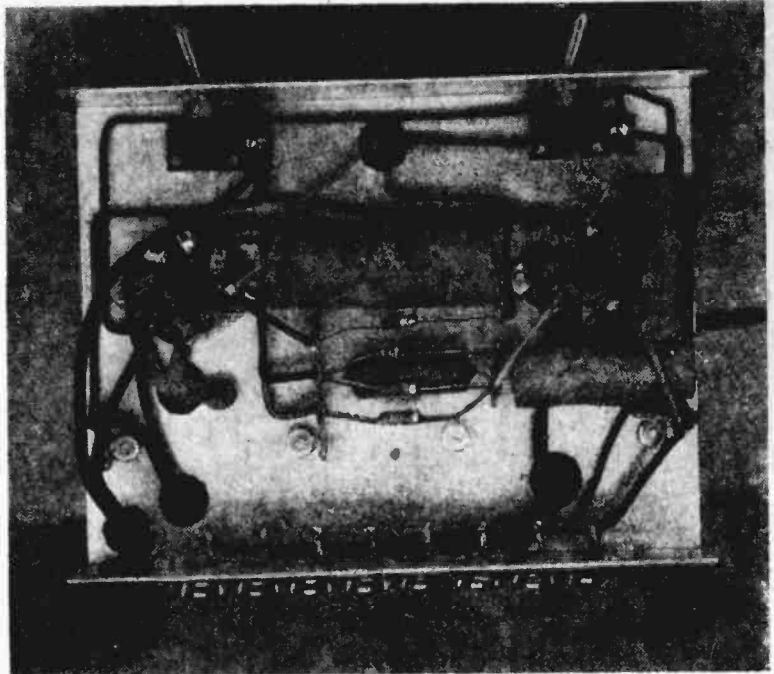

Underneath view showing components of the timer.

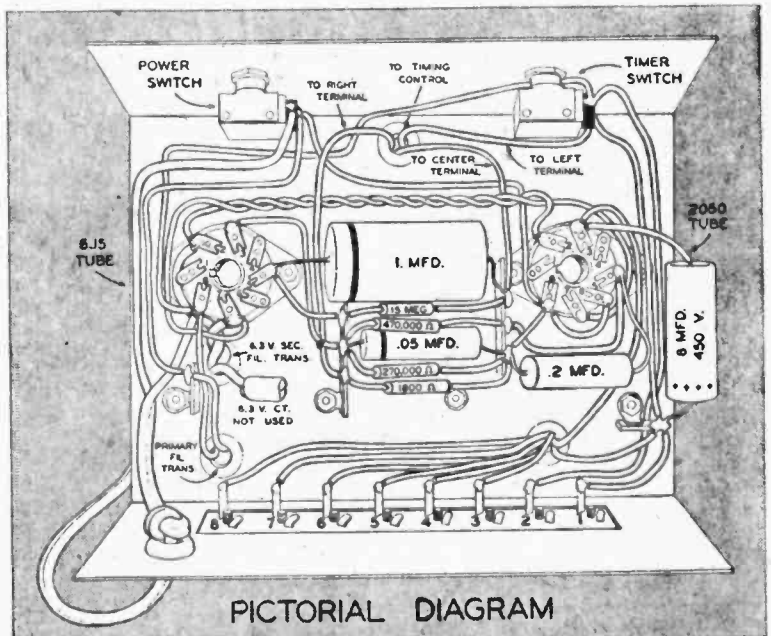

PICTORIAL DIAGRAM

2 on the terminal strip. If this remote switch is a momentary push-button type, connect terminals 1 to 3, and 2 to 4 with wire jumpers. Then it is only necessary to depress the push button until the relay closes. The switch may then be released and the timing cycle will complete itself.

The duration of the timing cycle is dependent

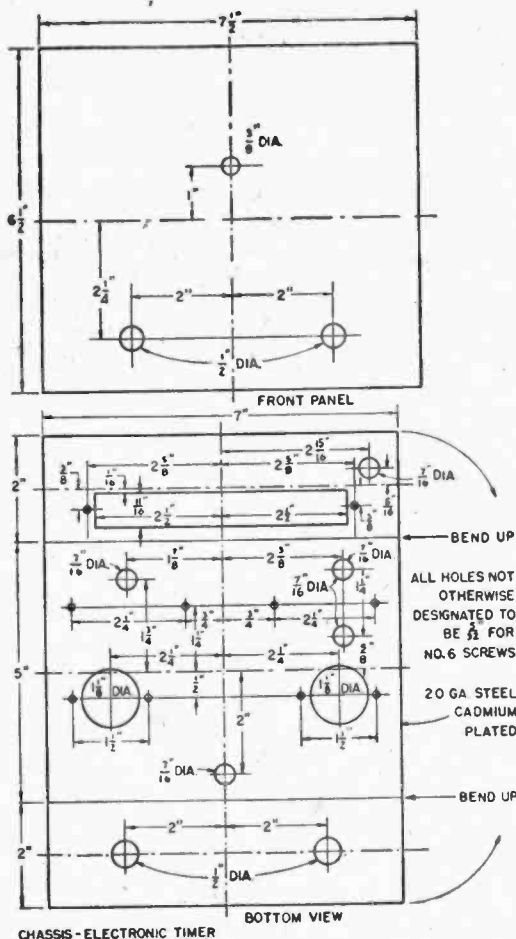

voltage is applied to the 2050 thyratron tube. Therefore no plate current will flow and the timing relay will stay open. At the same time the grid and cathode of the 6J5 tube act as a diode, charging up the 1 mfd. condenser in the grid circuit of the 6J5.

When the timing switch is closed the charge on the 1 mfd. condenser biases the 6J5 beyond the cutoff point, and no plate current flows through the tube and the 270,000 ohm plate load resistor. With no current flowing through this resistor no bias is applied to the 2050 tube and the tube conducts plate current which also flows through the timing relay and closes it.

The setting of the timing control determines the point at which the charge on the 1 mfd condenser no longer biases the 6J5 to cut-off. As the 1 mfd condenser discharges through the 15 megohm resistor in parallel with it the voltage across the condenser gradually decreases until this voltage is approximately equal to the voltage between the center arm and bottom end of the timing control. At this point the 6J5 tube conducts plate current which flows through the 270,000-ohm resistor. The resulting voltage drop

across this resistor is applied as a negative bias on the grid of the 2050 thyratron tube.

The plate voltage applied to the 2050 is pulsating dc and the dc bias which has been applied to the grid of this tube stops the plate current flow. With the 2050 plate current flow stopped the timing relay is deactivated and it opens to complete the timing cycle. This process is repeated when the timing switch is opened and closed.

Improved Rubber Grommets

• A rubber medicine-dropper bulb makes a handy rubber grommet for use where an electric cord passes through a metal radio chassis. Cut off the tip, insert the bulb through the hole in the chassis, and roll back the projecting end as shown in order to provide a flange for holding the grommet securely in place.—JOHN A. COMSTOCK.

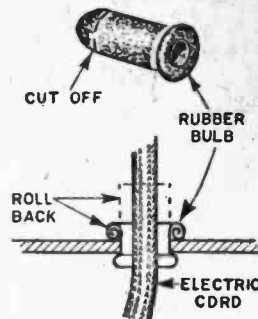

The Radioman's Third Hand

• The soldering of small parts such as eyelets, terminals and lugs is simpler and speedier with this small vise. Simply attach a suction cup to



a wooden clip-type clothespin, and fasten to any smooth surface.—L. J. DOWNES.

Mounting Polystyrene UHF Coils

• Here are two methods for mounting home made polystyrene UHF coil forms. Drill an undersize hole in one end of a length of polystyrene

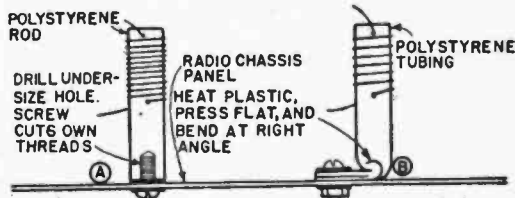

rod (A), and let the mounting screw cut its own threads. Use lock-washers when mounting. Heat one end of a length of polystyrene tubing, press the end flat, bend flat end at right-angles, and hold until cool (B). Drill a hole for the mounting screw through the flat portion.—A. T.

For short-wave listening away from home,
or to check on your own "set,"

Try This Portable Short-Wave Receiver

BY C. F. ROCKEY, W9SCH



Portable receiver brings in short-wave signals from a surprising distance. Vernier tuning dial helps to separate stations.

SIGNAL pick-up from transmitters several hundred miles away are normal with this 1-tube, inexpensive receiver that's battery powered and simple to build into a tackle box. I have picked up ships sailing off the coast of South America while fishing in the Wisconsin woods, using only a 20-ft impromptu antenna. While voice pickup is necessarily more limited than code, there's plenty of performance in this circuit that many old-timers will recognize as the regenerative circuit made famous by Lt. J. G. Schnell and the U. S. Navy.

I built the whole receiver in a metal "utility box" (sometimes called a fishing tackle box) that costs less than \$1 at most local variety stores. To punch holes use an ice-pick and enlarge them with the tang of a file. Even the wood shelves for the parts and batteries are simpler to build than the usual metal chassis.

Locating the wood shelves in the box is a good point to start construction. My shelves were $\frac{3}{4}$ x $2\frac{5}{8}$ x 5 in., but you may need to change dimensions to fit the utility box you plan to use. The 22½-volt "B" battery is wedged in place on the bottom shelf and copper contact strips hold the flashlight cells that provide "A" battery or fila-

ment voltage to the single tube (Fig. 3). Simple mounting of the batteries speeds replacement when they are exhausted. Since this bottom shelf is narrower than the box, the copper contact strips will not short out against the sides. Screws through from the outside hold the shelves in position inside the box.

The upper or socket shelf supports the tube, coil and most of the wiring. Screws (#6 x ½-in. rh) through the sides of the box into the wood of the shelf support this one, too. To locate the shelf, place the "B" battery in position and set the shelf firmly on it so it wedges the battery in place. Unscrew the shelf and complete the wiring according to the pictorial and schematic

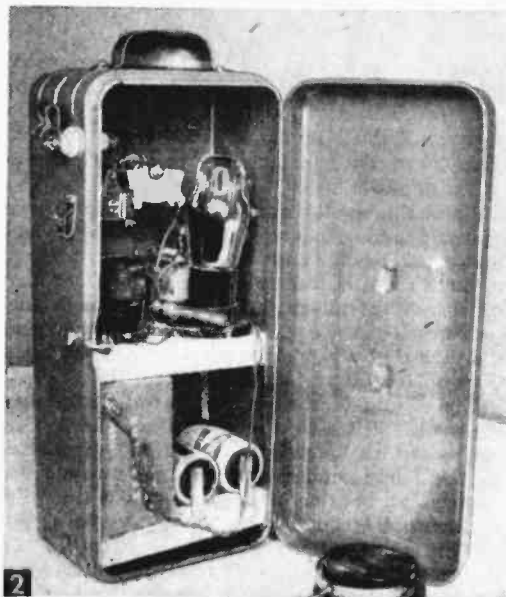

Two wood shelves separate radio components from batteries and simplify construction and wiring.

diagrams (Figs. 3 and 4). Solder all connections with rosin-core solder. Include in the wiring the hook-up to the coil socket. Directions on how to wind coils for the various short-wave bands will be given later when the receiver is ready to operate.

The insulated terminal strip for attaching headphones must be insulated from the cabinet (Fig. 4). The 1/16-in. Bakelite strip can usually be salvaged from an old radio panel. Drill the four holes in the strip and punch four matching holes in the side of the box. Using the tang of a file, enlarge the two holes corresponding to the terminals so they are large enough to clear the terminal screws with space to spare. Bolt or rivet the strip to the box with the other two holes (Fig. 4). This simple system leaves the terminals fully insulated.

The Johnson feed-through insulator for attaching the antenna mounts on the right side of the box, opposite to the upper headphone terminal. Punch and enlarge the hole so the bolt does not touch the metal box. The ground terminal screws directly to the box.

Now you're ready to install the tuning capacitor and other front panel controls. With the upper shelf in and the coil and tube in their sockets, locate the tuning capacitor, regeneration control capacitor and filament resistor on the front panel using the arrangement shown in Fig. 1 as a guide. Portions of these parts which extend back into the box should clear other parts enough

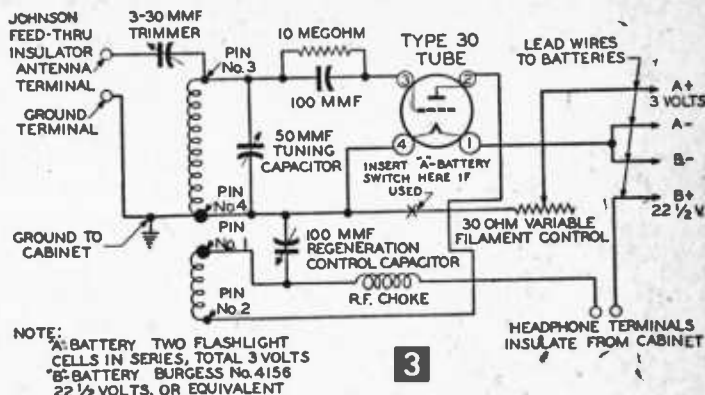

NOTE:
 "A" BATTERY TWO FLASHLIGHT CELLS IN SERIES, TOTAL 3 VOLTS
 "B" BATTERY BURGESS No. 4156 22 1/2 VOLTS. OR EQUIVALENT

3

TABLE A—PLUG-IN COIL WINDING DATA

| Band | Tuning Winding | Tickler Winding |
|---------------------------------------------|--------------------------------------------------------------------|-------------------------------------------------------------------------------------------------------------------------------------|
| 80-meter band (3.1 to 4.5 MC approximately) | 32 turns close wound lower end to Pin No. 3 upper end to Pin No. 4 | 15 turns "scramble-wound" at top of form as close to tuning winding as possible Outside of "hank" to Pin No. 2, inside to Pin No. 1 |
| 40-meter band (6.5 to 10 MC approximately) | 18 turns close wound lower end to Pin No. 3 upper end to Pin No. 4 | 10 turns close wound lower end to Pin No. 1 upper end to Pin No. 2 |
| 20-meter band (13 to 20 MC approximately) | 5 turns close wound connect as above | 5 turns close wound connect as above |
| Low-frequency end of broadcast band | 280 turns "scramble-wound" on tube-base connect as above | 50 turns "scramble-wound" adjacent to tuning winding connect as above |
| High-frequency end of broadcast band | 165 turns "scramble-wound" on tube base connect as above | 35 turns "scramble-wound" adjacent to tuning winding connect as above |

All above coils wound in same direction with No. 28 DCC wire.

to prevent damage if the receiver is banged about as most portables are. All of these front-mounted parts can be screwed directly to the metal box without insulation.

MATERIALS LIST—PORTABLE SHORT-WAVE RECEIVER

- 1—"utility box" (fishing tackle box) approximate outside dimensions 3 3/4 x 5 x 11 1/2"
- 1—brass drawer handle
- 4—Fahnestock terminal clips
- 1—3/16 x 1 x 2 1/2" plastic strip (for insulating headphone terminals from metal box)
- 2—wooden blocks, for mounting batteries and tube sockets respectively, dimensions 3/4 x 2 3/4 x 5"
- 1—Johnson feed-through insulator, ceramic 1 3/8" long
- 1—good "vernier" type tuning dial, salvaged from old broadcast receiver, or National type BM
- 1—type 30 tube
- 2—plain knobs
- 1—10 megohm resistor
- 1—50 mmf midjet variable capacitor, BUD No. MC-1873
- 1—100 mmf midjet variable capacitor, BUD No. MC-1875
- 2—base-mounting sockets, four prong, EBY type 12-4
- 1—3-30 mmf mica "trimmer" capacitor
- 1—100 mmf mica capacitor
- 1—wire-wound 30-ohm variable filament-control resistor, Mallory, type "U", or rheostat salvaged from old broadcast receiver. If

- optional switch is desired, use Mallory type 6-9, which will mount on back of control
- 1—22 1/2 volt B-battery, Burgess No. 4156
- 2—1 1/2 volt flashlight cells, standard size
- 4—brass strips, 1/4 x 1/4 x 1/2" (to make contact with flashlight cells)
- 1—2 1/2 mh R.F. choke coil, National R-100, or equivalent
- 3—4 prong bases, taken from discarded old-type tubes, or if not available then ICA coil forms No. 1108 B, sawn down to 1/4" length will be suitable. Two additional forms required to make broadcast band coils.
- 1—pr (2000 ohms or higher resistance) headphones of the magnetic type (crystal type will NOT do) Trimm "Dependable" No. 65
- 1—spool No. 28 DCC magnet wire, for coils
- hook-up wire, rosin-core solder, miscellaneous screws

Manufacturer's names are given for assistance in identification only. Second-hand salvaged, war-surplus, or those parts made by other manufacturers may be substituted with equally good results, provided only that their electrical and mechanical properties correspond with the specifications.

The vernier tuning dial is an absolute necessity for this portable receiver. In the short-wave spectrum, five or ten stations may come in between two of the main dial divisions.

Fastening on the control knobs and the handle across the top of the box completes the mechanical construction. Make sure the mounting screws are tight and the batteries fit firmly in their positions. With batteries hooked-up, turn up the filament resistance and observe the glow of the tube filament. Although any rheostats or poten-

With the filament circuit operative and the set complete except for the coils, you're ready to wind the various band coils that plug into the socket. Coil winding is the most critical job in building the set, so let's start with an "80-meter" coil as fewer problems arise from this band than those of higher frequencies. Fig. 5 shows the mechanics of the coil while Table A indicates the electrical details and the number of turns required for each band. All connections to the coil must be made *exactly* as indicated or the set will not operate. Be sure to solder tight connections where coil leads enter the pins on the coil forms. It may be necessary to saw off coil forms purchased from your radio supplier to fit the box.

When you complete the winding of the 80-meter coil, plug it in, insert the tube and connect the batteries, headphone, antenna and ground for a test run. Turn up the filament control resistor until the tube filament *barely* glows. From its minimum setting, gradually turn up the regeneration control capacitor (increase capacitance). At some point within its range, you should hear a definite increase in background hiss, followed by a soft "thud." This change in background hiss and "thud" is the oscillation point and represents the critical operating conditions for receivers of this type. If you don't hear the "thud," first unscrew the antenna trimmer capacitor a turn or two and try to find the oscillation point again.

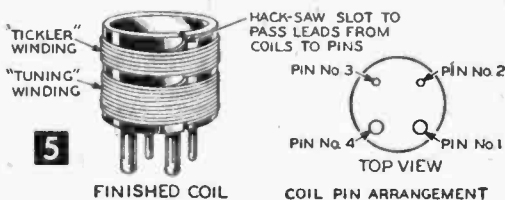
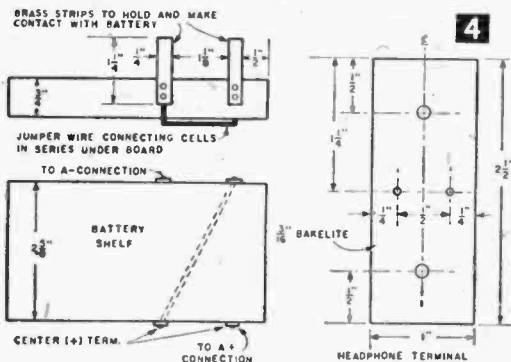
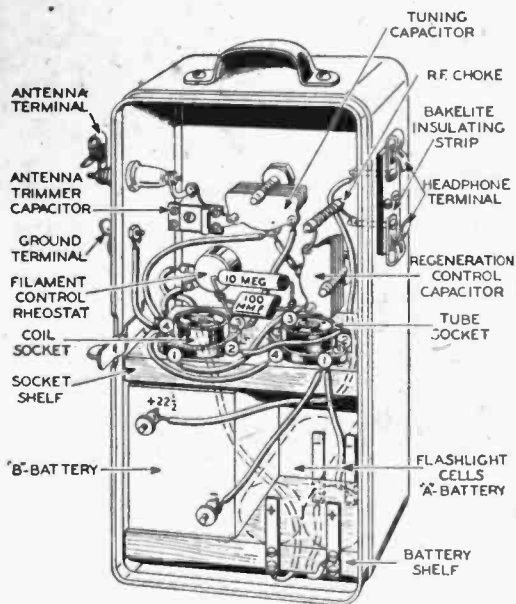

If there's still no well defined oscillation point, recheck the wiring, coil connections, batteries and tube. Most difficulties come from faults in the coil; sometimes, reversing the connections to the "tickler" winding of the coil helps.

When you have located the oscillation point, and can make the regeneration control pass through this point smoothly, you're ready for some serious listening. Your best reception of radiotelegraph (code) signals will be on the high capacitance side of the oscillation point. The best radiophone (voice) reception occurs just before you reach the oscillation point on the regeneration control. By tuning slowly and listening carefully, you'll be surprised at how much you can hear from a 1-tube battery-powered receiver.

You'll notice two coil specifications in Table A designed to receive regular broadcast band stations. Since circuit components have been selected for best performance on short-wave frequencies, you cannot expect top performance at the lower frequencies. However, these two coils will pick up broadcasts if you want music or sports programs in addition to short-wave reception.—END

tiometers likely to be used as filament control resistors in this set will have a definite *Off* position, you may prefer the positive action of an *Off-On* switch. If so, buy a suitable S.P.S.T. volume control switch and mount on the back of the control. This switch is then simply wired in series with the filament resistor at the point marked "X" in the diagram. If the tube does not glow, the tube is firmly in its socket and a check of the wiring shows it to be correct, you may have a faulty tube.

Short-Wave Converter

Your regular radio becomes a high-powered short-wave set with this simple frequency-changing device attached to its antenna post!

By THOMAS A.
BLANCHARD

YOU can listen to broadcasts (nearly all in English) from Argentina to Zanzibar with this simple short-wave converter, connected to any superheterodyne type radio. In an 8-hour period this converter brought in interesting news and educational broadcasts from Australia, Argentina, French Africa, Belgian Congo, England, Denmark, Russia, Spain, Switzerland, Turkey, plus distant U. S., Canadian and Central-American stations. The converter was attached to a 5-tube table set using a 1-lamp fluorescent fixture as a makeshift antenna.

A converter picks up the feeble short-wave signal by a tuned R. F. amplifier and tuned local oscillator-mixer and converts the signal from short- to medium-wave frequency. The standard broadcast set becomes an intermediate frequency (I.F.) amplifier for the converter. Thus a 2-tube converter used with a 5-tube radio often is equivalent to a specially designed 7-tube short-wave set.

The converter shown in Fig. 2 was assembled on a salvaged chassis because it matched a plastic

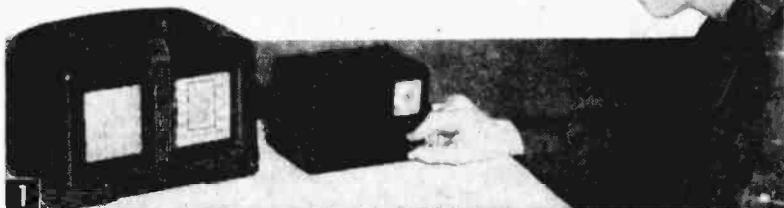

Converter attached to antenna of any standard superheterodyne radio adds world-wide short-wave reception.

cabinet on hand. Fig. 3 indicates a template which will fit most stock cabinets available from radio supply houses. Its width and depth can be varied to meet your own requirements. The chassis is the only special part required as all other items are stock radio materials.

You may wind the short-wave antenna and oscillator coils but their cost is so small that commercially made coils are advised. The antenna coil is wound on a $\frac{5}{8}$ -in. dia. tube with 12 turns of #20 solid plastic covered hook-up wire for the secondary. The primary winding is $2\frac{1}{2}$ turns of #30 enameled wire interwound among the last 3 turns of the secondary. The Hartley oscillator coil is a shielded type with an iron core slug to permit its matching to various 2-gang variable capacitors. This coil consists of 12 turns of #24 enameled wire with turns spaced $\frac{1}{4}$ -in. apart on a coil form measuring $\frac{7}{16}$ -in. dia. Bring out the tap at the 9th turn.

When using a standard broadcast band 2-gang superhet tuning condenser with a 420 mmf. R.F. section and 162 mmf. oscillator section, the oscillator coil slug screw projects $\frac{1}{4}$ -in. from the threaded bushing, and is locked in place with a 6-32 nut.

Check the Materials List, and order the components necessary before laying out the chassis. When parts are on hand, drill the small mounting holes because components do not always follow the same mounting dimensions even though their electronic characteristics are alike.

The filaments (heaters) of the R.F. amplifier tube (6AU6 or 6BA6) and the mixer (6BE6) operate from a small 6.3 v. filament transformer

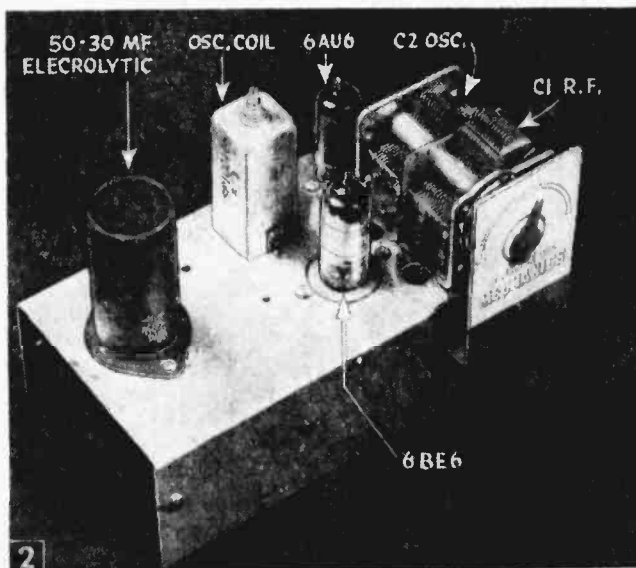

Converter components arranged on a salvaged aluminum chassis for easy wiring. Mark SW stations on blank dial as they are located. Pointer indicates 31-meter band position.

rated 1, or 1½ amps. Rectification for dc plate voltage is provided by a selenium disc rectifier of 100 ma. size with a 50-30 mfd. electrolytic capacitor rated at 150 working volts for dc filtering.

The circuit employs an isolated hook-up to minimize danger from shock. An external ground is automatically provided through the power line. However, to keep background noise at a minimum, and also increase converter's sensitivity, ground the converter chassis to the receiver chassis or external ground (but not both). Should ac hum be present on higher frequencies, merely reverse plug of converter and/or set in electrical outlet.

Wire components with leads as short and direct as possible. "Pigtail" leads on condensers and resistors are usually long enough for wiring and save on hook-up wire. All resistors in the B+ circuit attach to a 1-lug soldering terminal. A similar 1-lug insulated strip is used for all isolated ground (B-) connections. Locate the line switch at a convenient spot.

Because tuning of short-wave stations is very critical, the circuit includes an auxiliary fine

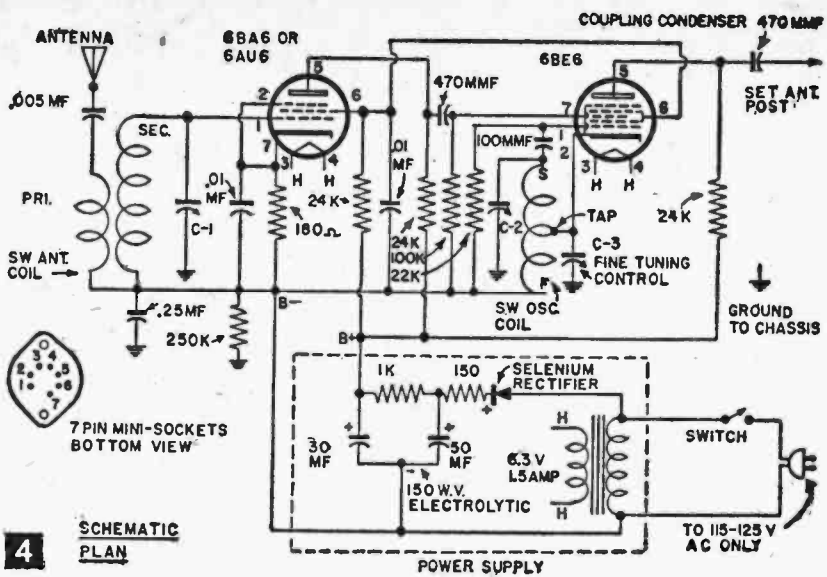

4

SCHEMATIC PLAN

MATERIALS LIST—SHORT-WAVE CONVERTER

- 1 Pc. #16 aluminum, 6½ by 7¼, for chassis
- 1 Pc. #16 aluminum, 1¾ by 4¾, for dial plate
- Capacitors**
 - 1 2-gang variable (420 mmf. R.F. section, and 162 mmf. Osc. section) with drum shaft for dial drive. C-1 (in schematic) is 420 mmf. and C-2 is 162 mmf.
 - 1 Midget air trimmer, approx. 35 mmf. max. capacity (C-3)
 - 1 Electrolytic can type, insulated capacitor. 50 & 30 mf., 150v.
 - 1 0.25 mf. molded paper capacitor, 150 w.v. or higher
 - 2 .01 mf. molded paper capacitor, 150 w.v. or higher
 - 1 .005 mf. molded paper capacitor, 150 w.v. or higher
 - 2 470 mmf. molded mica or ceramic capacitors
 - 1 100 mmf. molded mica or ceramic capacitors
- Resistors**
 - 1 150 ohm carbon resistor, 1 watt
 - 1 1K (1000) ohm carbon resistor, 1 watt
 - 1 180 ohm carbon resistor, ½ watt
 - 1 22K (22,000) ohm carbon resistor, ½ watt
 - 3 24K (24,000) ohm carbon resistor, ½ watt
 - 1 100K (100,000) ohm carbon resistor, ½ watt
 - 1 250K (250,000) ohm carbon resistor, ½ watt
- Coils**
 - 1 Short-wave antenna coil. (Stanwyck #402; 5.5 to 18 mc.)
 - 1 Short-wave oscillator coil. (Stanwyck #231-1; 5.5 to 18 mc.)
- Misc. Components**
 - 2 7-pin miniature tube sockets
 - 1 100 ma. selenium rectifier
 - 1 6AU6 and 6BE6 tubes
 - 1 2-screw terminal strip
 - 2 1-lug soldering strips
 - 1 dial drive bushing, pointer misc. hardware and knobs.
 - 1 Line switch and card

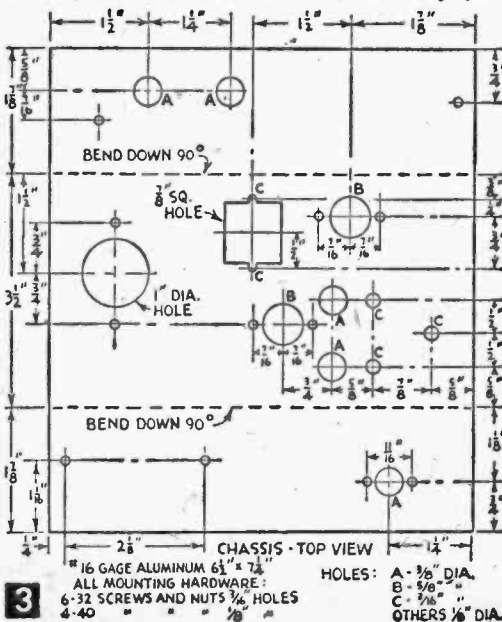

3

CHASSIS - TOP VIEW
 16 GAGE ALUMINUM 6½ x 7¼
 ALL MOUNTING HARDWARE
 6-32 SCREWS AND NUTS 3/8"
 4-40 1/8"
 HOLES: A - 3/16" DIA.
 B - 5/16" DIA.
 C - 3/8" DIA.
 OTHERS 1/8" DIA.

tuning control. Where one station is received at a given spot on the dial of a regular broadcast set, there may be 5 or 6 short-wave stations in the same tuning area on the converter dial. A midget air trimmer of about 35 mmf. maximum capacity connected across the tap and negative return of oscillator coil provides this fine tuning control.

The plates of the fine tuner are normally kept in the unmeshed (open) position. With the main tuning knob of the converter, tune slowly until picking up a station. Now use the fine tuning control to spread out the stations on a particular band. When a specific short-wave band is lo-

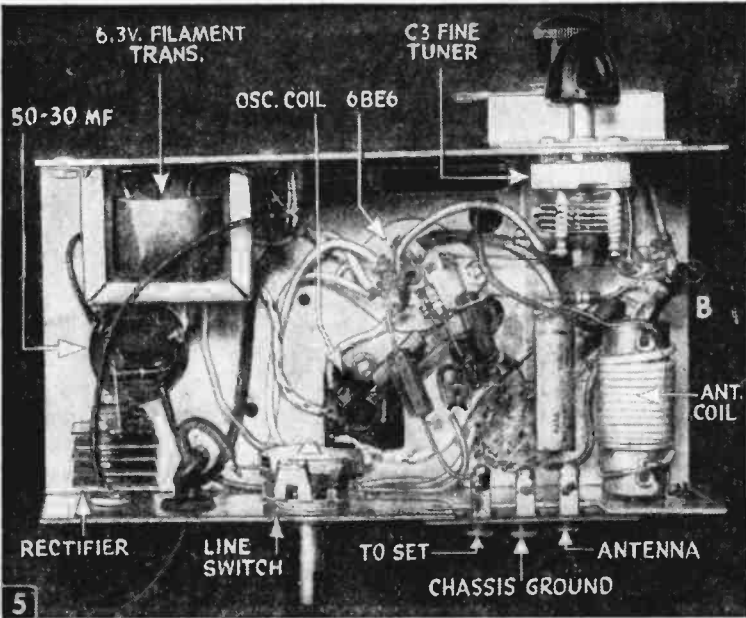

Bottom view of converter showing components mounted on underside of chassis.

cated (19, 25, 31 or 49 meters) mark the location in pencil on the hand-made converter dial.

The midget variable condenser spreads individual stations. Turning the dial of the broadcast set left or right "peaks" the I.F. for each station received. Set the dial of the regular broadcast receiver to some suitable intermediate frequency between 800kc. and 1000kc. The broadcast band radio dial doesn't tune in the short-wave station, and you only turn its dial for extra sharp tuning. When changing stations, always return the radio dial to its original setting at a spot where no regular station comes in. Use the volume and tone control (if any) on the usual broadcast set.

If the short-wave converter is used with a small table radio with a built-in loop antenna, it isn't necessary to disconnect the converter output lead to the radio antenna; when converter is shut off, radio performs normally. In cases where converter is used with a radio that requires an outside antenna, connect a small shorting switch across the converter input to cut out the converter when receiving on the regular broadcast band. If your table superheterodyne receiver has no antenna connection, connect the converter to the end of the loop wire soldered to the stationary plates of the R.F. tuning section of gang capacitor (large plates), and change the 470 mmf. coupling capacitor in the converter to a 20 or 50

mmf. size, or a mica adjustable trimmer capacitor may be used.

A cord dial drive provides vernier tuning adjustment although a 2-gang superhet tuning capacitor can be coupled to the 1/4-in. shaft for direct knob tuning. The drum tuner for a cord drive requires a dial pointer, length of linen dial cord, and a drive shaft assembly—all very inexpensive. Thread the dial cord as in Fig. 7. First close the capacitor plates, and tie one end of the cord to the tension spring. Before tying the final knot at the tension spring, be sure all slack is out of cord. If cord stretches, move the tension spring to an adjacent hole in drum. Make

up a dial plate as shown in Figs. 2 and 6.

Getting the Set Into Operation

An outdoor antenna for short-wave reception need not be more than 50 ft. long or you can pick up signals with a short indoor lead, metal curtain rod or other non-grounded metallic object. If trimmer screws on 2-gang tuning capacitor are tight at time of purchase, loosen them by screwing out half a turn and leave them that way.

Reception on various short-wave bands varies from day to day. At times reception below 20 meters may be impossible, while other bands are okay and vice versa. Reception in the 31 meter band is fairly consistent, but reception of various stations in this band may vary. Skip effect some-

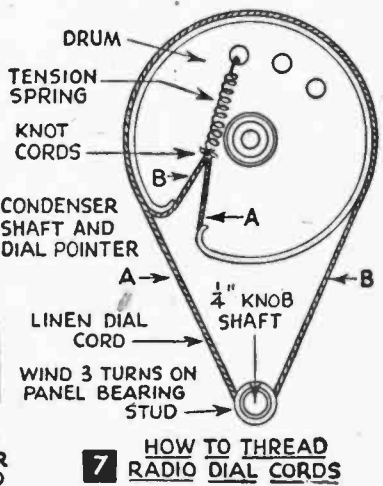
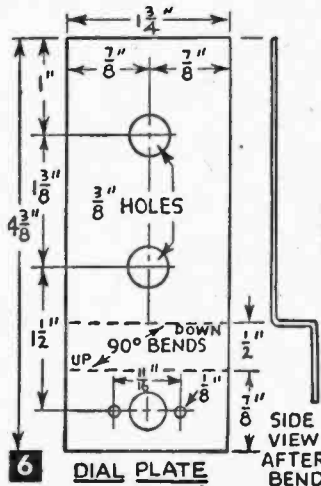

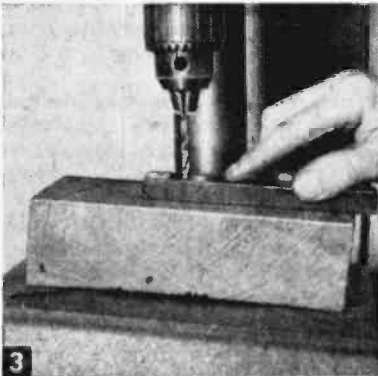

3

By tipping the drill press table the two holes drilled for the ends of the arms are given a 5° slant or you can hand drill by shimming up one end of the piece to get the right slant.

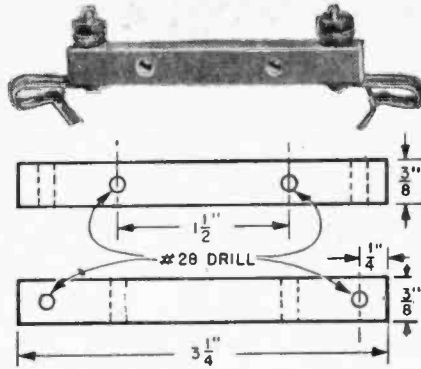

4 TERMINAL STRIP - 1 REQ.
BAKELITE

Completed terminal strip equipped with two Fahnestock clips and terminals for lead-in wire connections (Fig. 2).

MATERIALS LIST—TV ANTENNA

- 1 pc 3/4" birch or pine plywood 6 1/4 x 7 1/2"
- 1 pc paper base Bakelite 1/2 x 1 1/4 x 5 5/8"
- 1 pc paper base Bakelite 3/8 x 3/8 x 3 1/4"
- 2 Fahnestock clips
- 2 pcs hard aluminum rod 5/32" diameter x 72" long
- 4 rubber drive-in base knobs (rubber tack bumpers)
- 2 #7 rh wood screws 1" long
- 2 6-32 rh machine screws (brass) 7/8" long
- 4 brass 6-32 nuts
- 4 brass washers
- 2 6-32 rh brass machine screws 3/4" long

About 3 feet twin lead-in wire, stain and shellac
SOURCES OF SUPPLY: For Bakelite, try Forest Products Co., 196 Broadway, Cambridge, Mass. Fahnestock Clips, lead-in wire and rubber base knobs may be obtained from Allied Radio, Dept. 10, 100 N. Western Ave., Chicago, Ill. For aluminum rod, metal supply or products company, see your classified telephone directory.

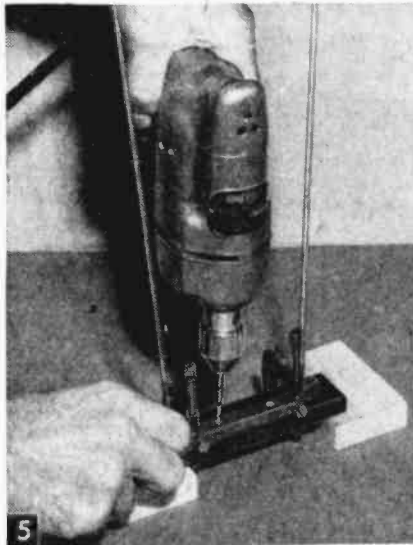

5

Drilling holes for 6-32 screws which attach terminal strip to base piece. Note that ends of antenna arms are put in position to line up the parts.

and the ends of the rods go down in the spring loops of the clips (Fig. 2) to make good contact and also serve to hold the rods in position. You may need to bend the loops out slightly in order to fit the 5/32-inch dia. rods. To make sure clips are placed right on Bakelite so the rods will pass through the loops and enter the holes in the bottom Bakelite piece, use a short piece of rod stock as a guide at each end to insure proper alignment before drilling the holes for the 6-32 screws that secure the clips. The terminal strip attaches to the lower piece with two 6-32 screws (Fig. 5 shows how the holes are spotted for the screws). With the ends of the rods through the loops of the clips and also pressed down in the lower Bakelite piece, use two small C clamps to hold the top piece in position for drilling (Fig. 5). Drill and then tap

the holes for 6-32, and then screw terminal strip to base piece. Next screw the assembly to the plywood base with two 1-inch #7 rh wood screws (Fig. 2) to accomplish this.

Making Antenna Arms

The 5/32-in. dia. aluminum rod stock is of the hard 17ST4 type. You'll need to get two 6-foot pieces from a local dealer in metal and metal products (look under these classifications in the yellow pages of your classified phone directory). Bend the coiled ends around a 6-inch dia. V pulley as shown in Fig. 2. A small hole was bored in the pulley to receive a steel pin, under which the end of the rod is placed to hold it. The pulley is then turned by hand and the rod carefully

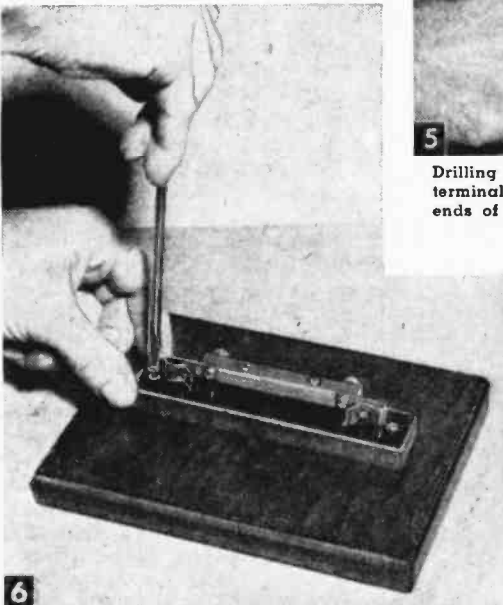

6

Roundhead wood screws fasten the Bakelite base piece to the wood base, through holes bored in the ends of the Bakelite.

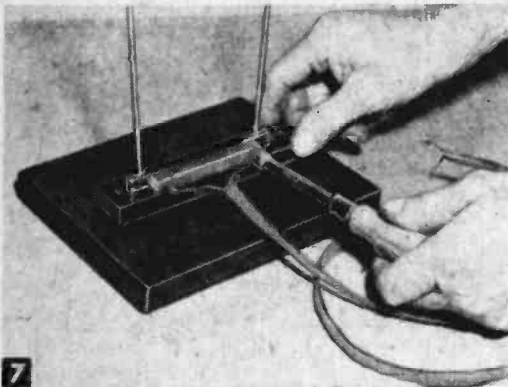

7

Connecting a short piece of twin lead-in wire to the terminals. The other end connects to the television set terminals.

wrapped around to form the coil. The stock springs out when released to some extent and you can then apply some hand forming to get the neat coils shown.

Before fitting the finished coiled rods into the base section, slightly round the ends of the rods so that they enter the Fahnestock clips easily when the lever is pressed, and press them down firmly in the slanting holes in the base piece. This construction allows the rods to be turned while the spring clips still hold them firmly in place.

Figure 7 shows how the short length of lead-in wire is attached to the terminals. After connecting the other end of the wire to the set terminals, you are then ready to try out the new antenna. If you wish, you can attach four rubber base knobs or felt to the antenna base to protect the surface of your TV set.—HAROLD P. STRAND.

Transistor Set for Code Practice

FOR those interested in mastering the International or Morse codes, an audio-tone oscillator is essential. Prior to transistors, two types of code practice circuits were popular. One was the vacuum tube *feedback* oscillator; the other was the neon-glow *relaxation* oscillator. The relaxation circuit was the simplest, but required a minimum of 60-volt *dc* to fire the neon lamp. The feedback circuit required a minimum of 22½-volt *dc* plate voltage, plus a 1½ to 6-volt filament or heater supply, depending upon the tube employed.

The circuit of this transistorized feedback oscillator has the simplicity of the neon-glow, the signal strength of the vacuum tube, and requires only one or two penlite cells for weeks of service. It may be used for solo practice, or two may send and receive with the same unit.

Following a simple breadboard design, the components are arranged on a 5 x 3½ x 5/8-in. baseboard (Fig. 2). The four Fahnestock clips attached to the base with ½-in. wood screws serve as terminals for attaching key and phones. The 4-lug tie strip secured near the baseboard center serves as a solder tie-point for capacitors, resistor and hook-up leads; it also provides a simple mounting for the P-N-P junction transistor.

The feedback inductance is the primary side of most audio output transformers. This is the transformer between the output tube of a radio set and its PM speaker, and you can salvage one from a junked radio, or buy a new one, purchased usually for less than \$1. Those advertised as 50L6 types are ideal, but any single plate-type output trans-



This transistor code practice outfit will operate for days on a single penlite battery. It is easily modified for 2-way use.

**MATERIALS LIST-
CODE PRACTICE SET**

- 1 5 x 3 1/2 x 5/8" wood baseboard
- 1 P-N-P Junction transistor, CK-722 (Raytheon) or RR-38
- 1 audio output transformer, 2500 to 10,000-ohm tube load
- 1 220K (220,000) ohm, 1/2-watt composition resistor
- 1 .002 mfd. paper capacitor (working voltage unimportant)
- 1 .02 mfd. paper capacitor (working voltage unimportant)
- 4 Fahnestock clips
- 1 transmitting key
- 1 pair, magnetic headphones, about 2000 ohms (do not use crystal type)
- 1 4-lug tie strip
- Miscellaneous, 1/2-in. rh wood screws, hook-up wire, penlite batteries

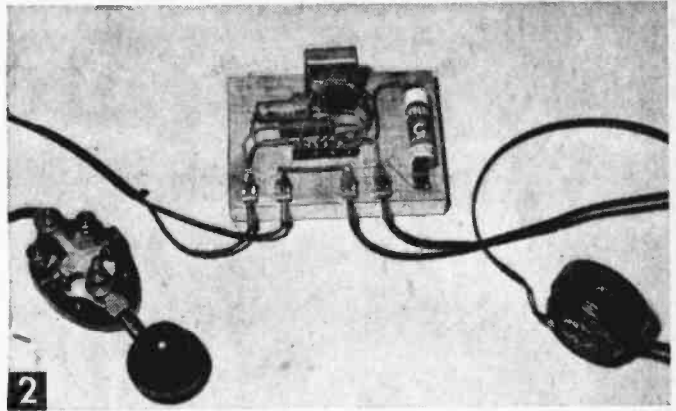

Transistor feedback oscillator requires no switch, since penlite cell is simply removed from base clips when unit is idle. Transformer may be eliminated when used for dual practice.

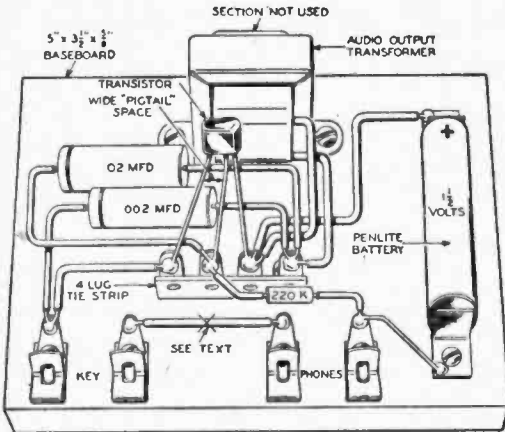

PICTORIAL DIAGRAM

former with a 2500 to 10,000-ohm rating will do.

Disregarding the two plain enameled voice coil secondary leads, connect the insulated primary leads (usually red and blue colored) at the tie-points as shown in Figs. 3 and 4.

Note that two small angle brackets (fashioned from spring brass, copper or tin) are screwed down to the base to secure a single penlite cell.

TABLE A—INTERNATIONAL MORSE CODE

| | | | |
|--------|--------|---------|---------|
| A .. | J | S ... | 2 |
| B | K ... | T - | 3 |
| C | L | U - | 4 |
| D ... | M -- | V | 5 |
| E .. | N .. | W | 6 |
| F | O --- | X | 7 |
| G ... | P | Y | 8 |
| H | Q | Z | 9 |
| I .. | R ... | 1 | 0 |

PERIOD
 COMMA
 ? MARK

Then, with key and magnetic phones connected, the transistor audio oscillator is ready for use. The headphones you use should be rated at about 2000 ohms or so (crystal headphones will not work in this circuit). For a stronger signal, use two penlite cells in series, which will then deliver 3 instead of 1 1/2 volts to the circuit.

If you want to learn the code (Table A) with someone else, connect another key and phone in series, break the lead marked "X" in Fig. 3, and you have a two-way system. Remember, however, that when one person is sending, the other must hold down his key to provide circuit con-

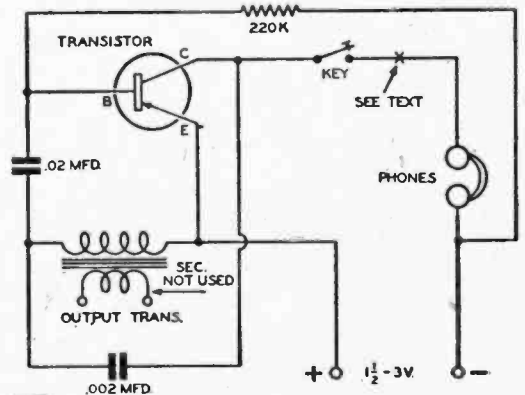

SCHEMATIC DIAGRAM

tinuity. Some keys have a built-in knife switch for this purpose.

If this transistor oscillator is built expressly for two-way transmission, the audio output transformer can be eliminated by installing clips for the second pair of phones where the primary leads are terminated. Thus the second pair of phones serves both as reproducers and oscillator coil. You then insert the additional key at "X" in Fig. 4.—THOMAS A. BLANCHARD.

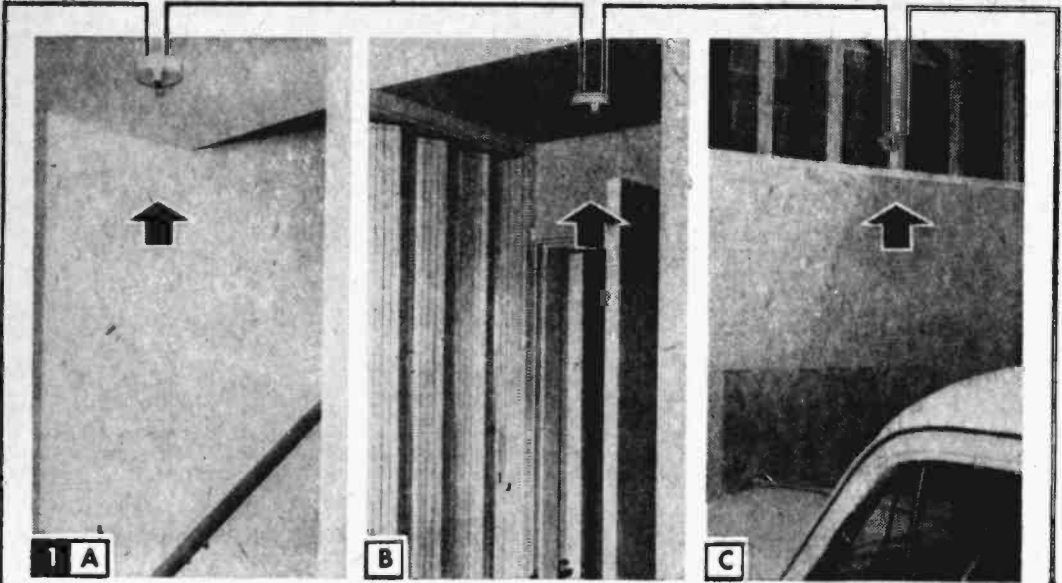

Here's your home fire alarm system. Note the Type 7020-1 Detect-A-Fire thermostatic units mounted on ceiling over base of stairway (photo A), and on ceiling over just inside door of bedroom near a closet (photo B). Photo C shows Type 7120 vertically-mounted Detect-A-Fire unit mounted in garage. Note that thermostat units are wired in series to the automatic alarm control unit (photo D) which you will build. Swinging the alarm unit cabinet open reveals these major components: (1) 6-inch alarm gong; (2) 50-watt signal transformer; (3) 6-volt Burgess electric fence type battery; (4) 0-10-volt DC voltmeter; (5) Edwards Lungen type 15, size 3 buzzer; (6) 5-terminal junction block.

Automatic Fire Alarm

By MILO A. ADLER

YOU of course don't want to run the risk of your sleeping family being trapped by a fatal fire in your home. But when it comes to buying or building an alarm which would prevent such a tragedy, if you're like I was when I first thought of this project, you probably don't know where to start.

I did know, however, what I wanted the alarm to do. First, it had to sound off automatically whenever fire suddenly boosted temperatures in my home. Second, it couldn't be the type that works sometimes and doesn't other times. And this meant that it had to be well built from reliable and non-temperamental

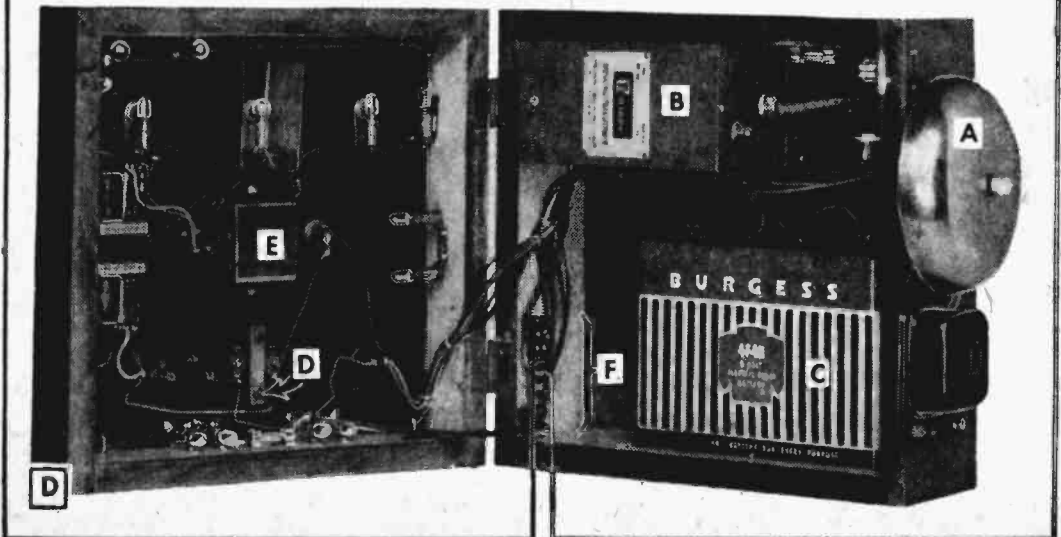

components. Also its operation could not depend on any uncertain factors such as the power line in the house.

This fire alarm meets all these tests. The circuits are so designed that they are under electrical supervision at all times. If a component fails at any time or the power source is interrupted, a warning is given by the master alarm control unit. In the event of a fire a large 6-inch gong rings continuously regardless of whether there is line voltage or not.

In other words, it is a reliable watchman and not a low-cost gimmick which may or may not work. Its components—the finest—will cost around \$75 (including three thermostat detectors) which is not peanuts, but then such safety insurance is worth it. And comparable commercial units would cost about \$200.

Basically, this fire alarm system consists of the alarm control unit shown in Figs. 1 and 2, and individual Detect-A-Fire thermostats mounted in critical areas of your home, garage or barn (A, B and C in Fig. 1) and wired to the alarm unit in such a way that they will sound the alarm whenever the temperature of the air around them reaches 140 or 160°F., depending on the thermostat and its mounting location. You'll need a minimum of three of these thermostats, as we will explain in detail later on in the article.

The alarm control unit operates from a 115-volt, 60-cycle power line and draws approximately 30 watts. In the event of a power failure relay RY-2 (see A and B in Fig. 3) is de-energized and the buzzer built into the master control unit sounds. You can then investigate the cause of power failure. If the house fuse has blown out, you can replace it after determining

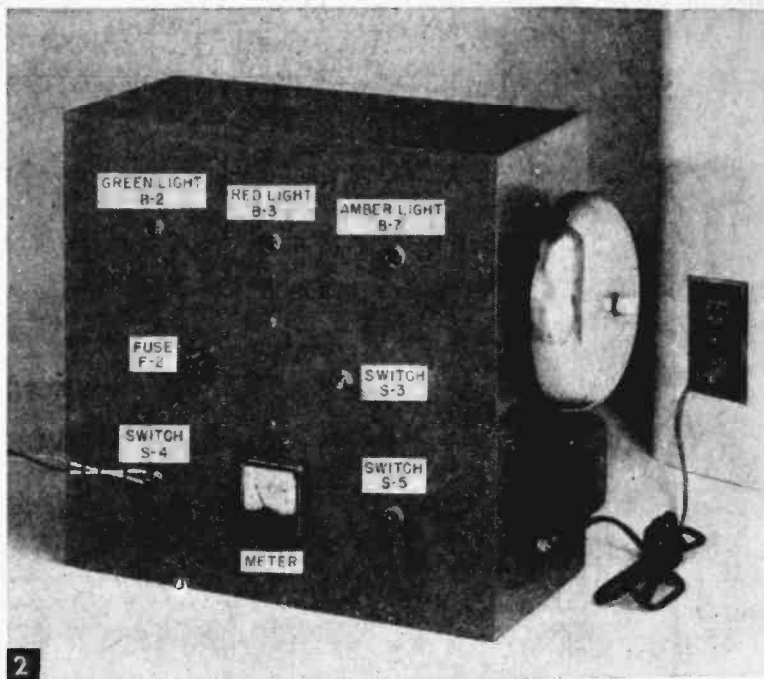

Front of closed alarm control cabinet.

PARTS LIST—AUTOMATIC FIRE ALARM
Fire Alarm Control Unit

| Quantity | Schematic Symbol | Description |
|----------|------------------|----------------------------------------------------------------------------------|
| 1 | T-1 | 50 watt signal transformer (Edwards No. 88-50) Edwards Co., Inc., Norwalk, Conn. |
| 2 | ... | Fuse Holder (Littlefuse 342003) |
| Box of 5 | F-1 | 1/2 amp fuse (Littlefuse 312.500) |
| Box of 5 | F-2 | 2 amp fuse (Littlefuse 312002) |
| 1 | B-3 | Red pilot light socket (Dialco type 710-431) |
| 1 | B-2 | Green pilot light socket (Dialco type 710-432) |
| 1 | B-7 | Amber pilot light socket (Dialco type 710-433) |
| 10 | ... | Miniature bayonet Dial lamp socket (Dialco type 705) |
| 10 | ... | #44 Dial lamps |
| 10 | ... | #45 Dial lamps |
| 10 | ... | #55 Dial lamps |
| 1 | R-1 | 5 ohm, 10 watt wire-wound resistor [IRC type 1 3/4A (AB)] |
| 1 | V | 0 to 10 volt d-c voltmeter (Emico type RF-2C) |
| 1 | S-1 | d.p.s.t. toggle switch (Cutler Hammer 8360-K7) |
| 1 | S-2 | s.p.s.t. toggle switch (Cutler Hammer 8280-K16) |
| 1 | S-3 | d.p.d.t. toggle switch (Cutler Hammer 8363-K7) |
| 2 | S-4 & S-5 | s.p.s.t. normally open push switch (Cutler Hammer 8411-K4) |
| 1 | Battery | 6 volt heavy duty battery (Burgess S-461 or 4F4H) |
| 1 | ... | 5 terminal barrier strip (Jones 5-140) |
| 1 | ... | Alarm bell with 6" gong or horn for 12 volt operation |
| 1 | ... | Buzzer (Edwards Lungen No. 15 size 3 or 4) |
| 2 | RY-1 & RY-2 | 6 volt a-c relay, 4 d.p.t. (Potter Brumfield MH17A) |
| 4 | ... | Fuse clips for mounting 1/4" spare fuses |

Miscellaneous wood screws, wire, B-X fittings, brackets, hinges and material for constructing the cabinet. Thermostatic Fire Detectors: Specify 140° F. or 106° F. and type 7020-1 for parallel mounting or type 7120 for vertical mounting when ordering the "Detect-A-Fire" units from the two sources given in the text.

the cause for its burning out (possibly preventing a fire before it starts). If the power failure is due to the breakdown of the utility company equipment, flip the switch (S-3 in Fig. 2) on the front of the master control unit to silence the buzzer. Meanwhile, relay RY-2 in the control unit has already switched the fire alarm circuit to the built-in battery. When your power is restored by the utility company, the relay will automatically

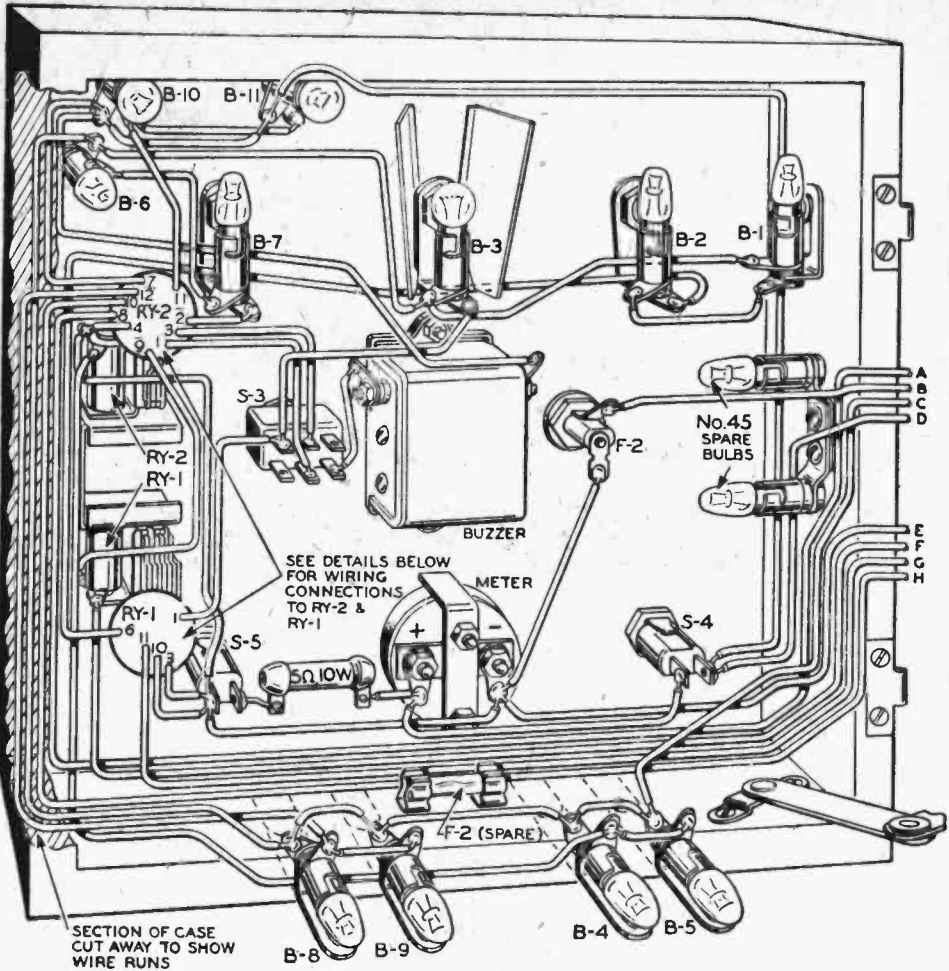

A

B

C

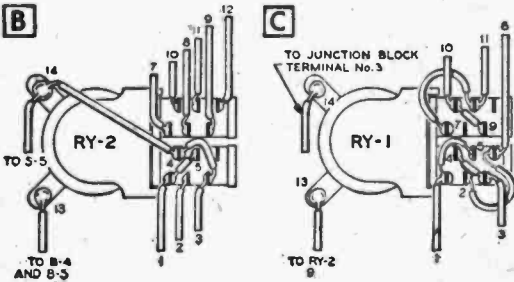

switch the fire alarm circuit from the battery to the transformer and light red light on front of control unit (Fig. 2). No alarm is sounded when this automatic switch-over takes place. But next morning when you see the red light, you flip S-3 (Fig. 2) to turn it off and restore the buzzer alarm circuit to normal.

If there is no power failure for any length of time, the automatic switching system will allow

the battery to last for at least 12 months. But you can easily use the built-in battery (Fig. 1D) once a week to test the condition of the battery—a wise precaution.

The coils of the two relays are designed for 6.3 volts a-c (Figs. 3 and 4). To operate these relays from the battery and the 8-volt transformer tap, it is necessary to use dropping resistors. After experimenting with both fixed wire-wound resistors and dial light bulbs, we chose the dial bulbs, which cost no more, give a visual indication they are functioning, and tend to keep voltage applied to relay coils constant (so that line voltage can vary from 90 to 130 volts without affecting performance). Also, the sealed glass dial lamps are not subject to dampness or corrosion and can be easily replaced without tools. Because the bulbs operate at reduced current and voltage, they will last indefinitely (with the exception of the red bulb which operates at full current and voltage).

For quick replacement, note the spare 2-amp fuse for F-2 mounted in clips between lamps B-9

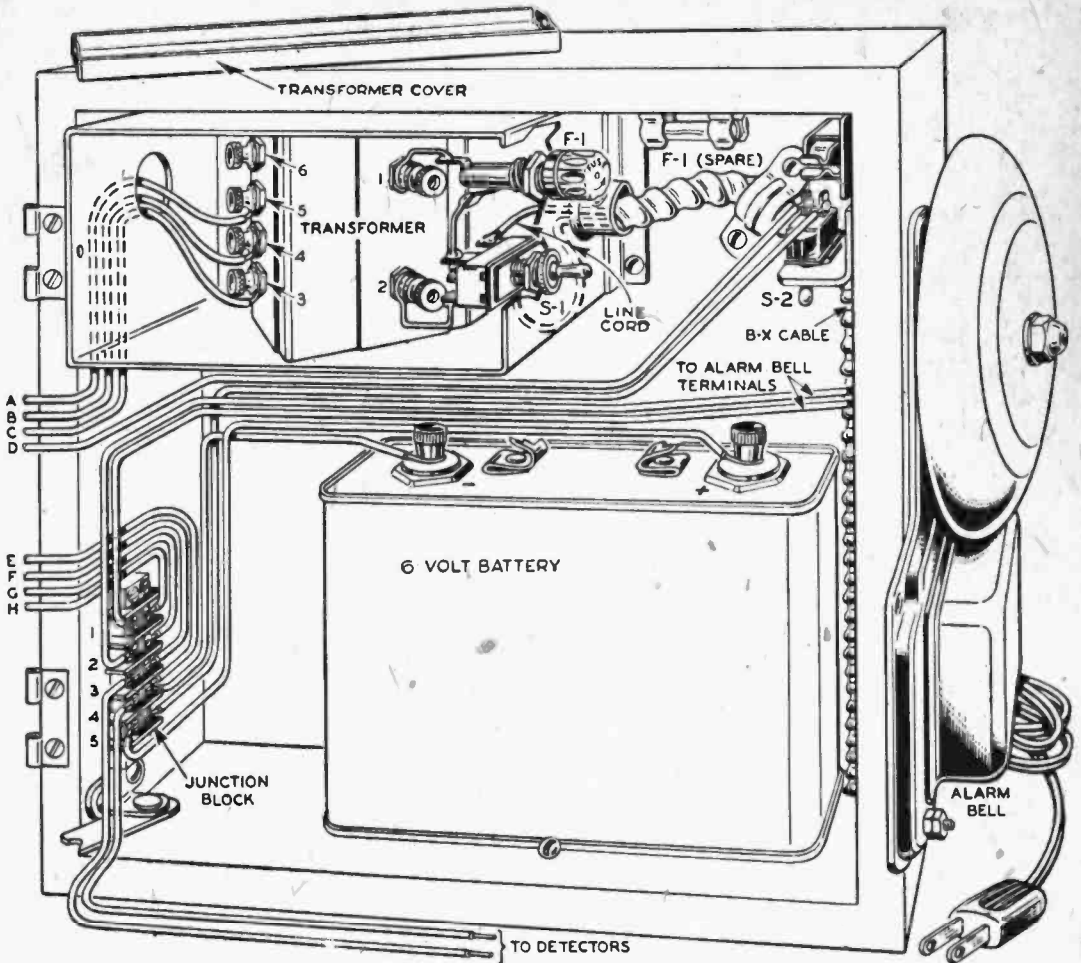

3 PICTORIAL DIAGRAM - ALARM CONTROL UNIT

D

and B-4, and a spare .5-amp fuse for F-1 mounted just above the two off-on switches S-1 and S-2 (Figs. 3A and D). Also note two spare, type 45 bulbs for B-4, B-5, B-8 and B-9 are mounted just below bulbs B-1 and B-2.

For the alarm control unit cabinet (Fig. 5), use 3/4-in. smooth clear, well-seasoned pine for the back and sides, and 1/4-in. tempered Masonite for the front. Glue all the joints and build the cabinet as one solid box; then saw it in two to obtain a perfect fit between the hinged front and back sections, which are then joined with two 1 1/2-in. butt hinges mortised 2 in. from the ends. You can use either the furniture-type cabinet stop shown in Fig. 1D to prevent the front from swinging too far open, or a piece of stout string tied between two staples on the inside top of the front and back.

Mount buzzer on inside of front cover (Fig. 6) and drill mounting holes for the three switches, F-2 fuse holder, three colored dial lamp sockets,

and the 2-in. meter mounting hole (B in Fig. 6). Use a small drill followed by a reamer to obtain close-fitting mounting holes. Mount a cabinet latch in upper right corner (Figs. 1 and 6A) to hold front closed. Paint cabinet with two coats of paint to match wall on which you will mount control unit.

While the cabinet is drying, drill mounting holes and mount the S-1 switch and F-1 fuse holder in the end of the transformer case (Figs. 3D and 7). You drill these holes 1 in. from top of case with the cover removed, and 1 in. from each side. Now make the relay mounting brackets and battery switch (S-2) mounting bracket as in Figs. 8 and 9. Cut the light shield for the center red light. (Figs. 6A and 10) from a tin can, roll the edges for rigidity and solder it to the socket mounting bracket.

Mount the relays on the brackets with size 3-48 machine screws which are just long enough to go through the mounting bracket and into

TABLE A—WEEKLY BATTERY TEST

Once every week, turn S-1 and S-2 for normal operation, and then:
 1. Depress S-4. Meter should read over 4 volts.

2. Depress both S-4 and S-3. Meter should read over 4 volts but slightly less than in step 1. Release S-3 as soon as reading is obtained to remove the battery load.

If the battery reads under 4 volts in either test, replace it immediately. If meter reads in the wrong direction on your first test, your connections to the battery or the meter are reversed.

switch (Fig. 2). Leave this switch so that buzzer is off. (2) Remove bulb B-10. The B-11 bulb should now become brighter (Fig. 3). (3) Next, remove bulb B-11 and the alarm bell should ring. (4) Now replace both bulbs and momentarily disconnect jumper wire between terminals 3 and 4 on the junction block. Again the alarm bell should ring.

This checks your wiring and connections for battery operation of the control unit. If any of the tests don't work, check wiring of the junction block, B-10, B-11, RY-2 terminals 11 and 9, and RY-1 terminals 7, 9, 10, 11, 13 and 14 (Fig. 3). Leave the switches S-2 and S-3 in the positions determined by steps 1, 2, 3 and 4.

To check the battery test circuit, follow steps outlined in Table A.

To continue your tests of the alarm circuit, next turn on S-1 (the *a-c* off-on switch). Bulbs B-10 and B-11 should go out (Fig. 3). Bulbs B-1 through B-9 should all go on with red bulb B-3 brighter than all the rest, and relay RY-2 should be actuated.

Now switch S-3 on front panel to its other position. Bulb B-3 should go out. Next, momentarily remove bulb B-6. Bulb B-7 should go out and then come back on when B-6 is replaced. If this checks out, momentarily remove bulb B-1. Now bulb B-2 should go out and then come back on when B-1 is replaced.

When you temporarily remove both bulbs B-4

and B-5, the buzzer should go on and then off when the bulbs are replaced. Now, temporarily remove both bulbs B-8 and B-9. The alarm bell should go on, and then off when the bulbs are replaced. When you switch S-1 to the off position, the buzzer and bulbs B-10 and B-11 should go on, and all other bulbs should go out. Flip switch S-3 on the front panel to silence the buzzer. Removing fuse F-1 or fuse F-2 should give the same results as turning off S-1. To turn off the red light, switch S-1 to the on position and flip switch S-3.

With S-1 and S-2 in on position and S-3 set so that red light B-3 is out, remove wire jumper between terminals 3 and 4 on junction block (Figs. 3 and 11). The alarm bell should ring, bulbs B-1, B-2, B-8, and B-9 should go out, and red bulb B-3 should go on. Flip S-1 to the off position. The buzzer should go on and bulbs B-4, B-5, B-6 and B-7 should go out. Finally, flip S-2 to off position, and both bell and buzzer should go off.

If any of these tests do not give the results specified, recheck all the wiring, since the action of the relays interconnects all the various circuits. To turn the unit on without causing either bell or buzzer to go on, first turn on S-1 and then S-2. Reverse this procedure to turn the unit off.

After testing the operation of the control unit, mount it at eye level on some wall where it is easily accessible, will be seen every day, and the

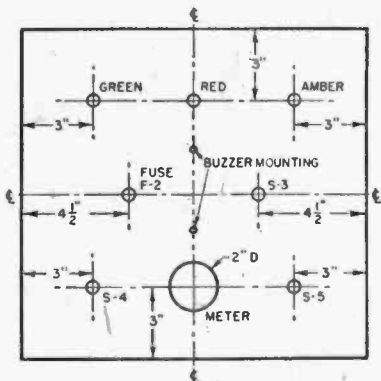
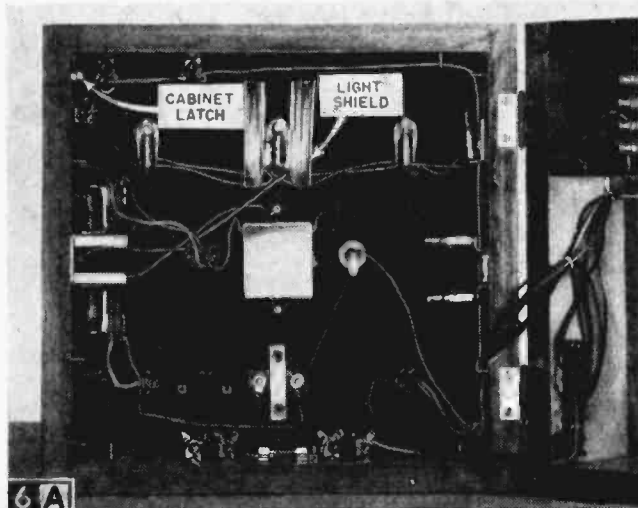
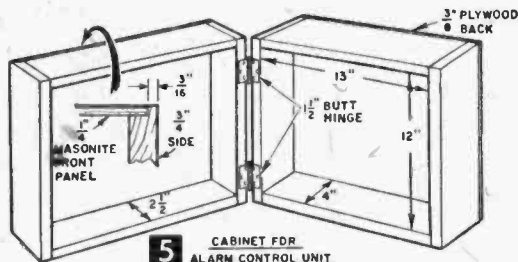

Front panel layout showing mounting of components. Diameters of holes to be drilled should be determined from actual components used. Note that buzzer mounts on inside of front panel.

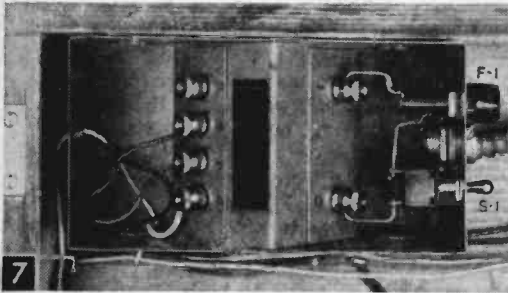

7 Closeup of transformer with case cover removed, showing F-1 fuse and S-1 switch mounted in end of case.

buzzer can be heard throughout the house (the basement may be too far away). It's wise to mount the unit, or at least the bell alarm, near the bedrooms to be sure it will do a fast job of waking up Dad in case of a fire.

Installing the Master Control Unit, Alarm Bell and Thermostats

With the alarm unit installed, you are now ready to install the thermostats—the “eyes and ears” of the system that will signal the presence of fire to the alarm unit. The Detect-A-Fire thermostat units this system uses (A, B and C in Fig. 1) are made by Fenwal Inc., 218 Pleasant St., Ashland, Mass., or 111 South Burlington Ave., Los Angeles 37, Calif. Hermetically sealed in a stainless steel tubular shell which permanently protects the internal mechanism (Fig. 12); these units resist shock and vibration and will last as long as the house lasts. Also, if actuated, this type of thermostat automatically resets itself when the temperature drops below its operating temperature. When the air surrounding the temperature-sensitive tube reaches the predetermined factory setting of the detector, it signals the alarm immediately, regardless of the rate of air temperature rise.

For your home protection, you will want thermostats set for 140°F or 160°F (see Fig. 13).

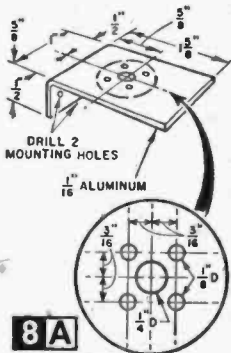

8A RELAY MOUNTING BRACKET

Closeup of relays RY-2 and RY-1 mounted in their brackets (see inset).

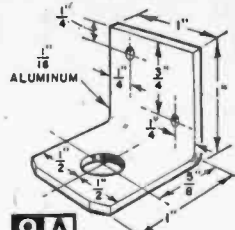
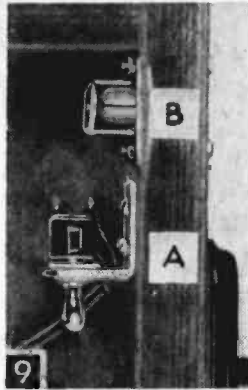
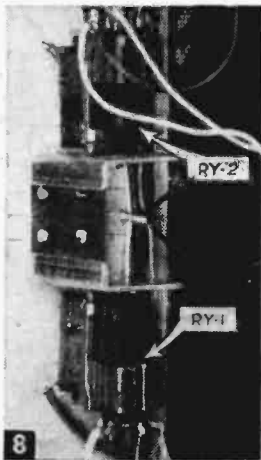

9A BATTERY SWITCH BRACKET

Closeup of battery switch mounted in its bracket (A). Spring type friction latch for holding alarm unit closed is shown at B.

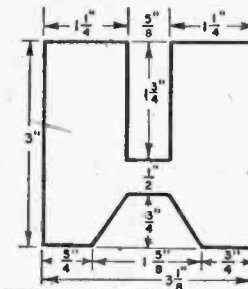

10 LIGHT SHIELD FOR RED LIGHT

Use the 160°F units (coded with a small spot of black paint on a yellow background) for attic spaces or over heating equipment such as furnaces and stoves. For other areas in the house, which are coded with just yellow on the back side of the unit.

For 100% protection, you would need a Detect-A-Fire unit in the center of the ceiling in each room and closet, the attic, at the head of the stairways, and over the home heating equipment. Insurance companies have found, by the way, that most home fires start in the attic, kitchen and basement. To calculate an adequate coverage in large areas, note that the Underwriters' Laboratory lists these units to cover approximately 610 sq. ft. (a circle of 28 ft. diameter). For larger areas add detectors as required

TABLE B—30-DAY SYSTEM TEST

Once every 30 days, follow this test procedure:

1. Turn on S-1 and S-2. Bulbs B-1, B-2, B-4, B-5, B-6, B-7, B-8 and B-9 should all be on.
2. Remove B-4 and B-5. Buzzer should go on, B-8 and B-9 should go off, B-6 and B-7 should go off, B-6 and B-7 (amber) should go off, B-10 and B-11 should light, B-3 (red) should be off, and B-1 and B-2 (green) should light.
3. Flip Switch S-3 to silence buzzer. Bulb B-3 (red) should light.
4. Remove B-10 and B-11. Alarm bell should ring, B-3 (red) go on, and B-1 and B-2 (green) should be off.
5. Replace B-10 and B-11. B-10 and B-11 should light and B-3 (red) and B-1 and B-2 (green) should light.
6. Replace B-4 and B-5. All bulbs except B-10 and B-11 should be lit and bulbs B-10 and B-11 should be off.
7. Flip S-3 on front panel. Red bulb B-3 should turn off.
8. Remove B-8 and B-9. Alarm bell should ring, B-3 (red) should light, and B-1 and B-2 (green) should be off.
9. Replace B-8 and B-9. Results should be the same as step 6.
10. Turn a-c switch S-1 off. Buzzer should go on, bulbs B-10 and B-11 should light and all other bulbs should go out. The same results are obtained if either fuse F-1 or F-2 burn out or are removed.
11. Turn a-c switch on to restore to normal operation.

Check for wires or connections that show any sign of deterioration or corrosion, and replace any that do.

with the distance between the units not greater than 25 ft.

At this writing, each detector unit costs about \$14 (sometimes less if quantities are used). Your pocketbook and your conscience will have to decide how many units you want to use—but an absolute minimum would be three Detect-A-Fire units: a 160°F detector in the attic and over the furnace and one 140°F unit in the bedroom area, at the head of the stairs leading to

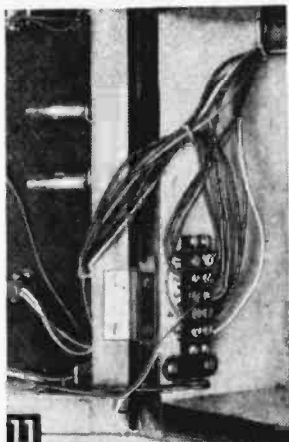

Note how wires running between front and back sections of alarm control unit are slanted for greater flexibility. Numbers 1 to 5 represent terminals on junction block. Jumper wire used for circuit test will run between terminals 3 and 4.

second story bedrooms, or on the hall ceiling where the heat will travel before going upstairs. Additional units may be added at any time.

If you can't install the detector in the center of the ceiling, mount it on a wall as close to the ceiling as possible (never more than 20 in. down from the ceiling).

Fig. 1 shows how the detector units are hooked up in series with the alarm unit. If you want to have two wires run between each detector unit and the master alarm unit, this will allow temporary removal of a detector unit from the circuit if trouble develops in the detector or its wiring. If you want, you can use a Jones-type barrier strip mounted inside the master control unit as a terminal connecting board for these wires. Use a strip with one less terminal than the total number of detectors.

All detector units are connected in series, and the sequence is not important. Connect one wire from any detector to terminal 3 on the junction block (Figs. 1 and 3). Then connect the second wire from the first detector to either wire from the second detector. Next connect the second

TABLE C—6-MONTH DETECTOR TEST

Once every 6 months, check all detectors as follows:

1. Turn the alarm unit on. The green and amber lights should go on.
2. Turn S-3 on the front panel so the red light is off. Mount a 100-watt bulb in a tin can that will slide over the mounted detector. With the bulb on and fully heated, place the can over all the detector units one by one. In each case when the air around the detector heats to the point where it is actuated the alarm bell should ring and the red light should go on. The alarm should turn off a few moments after the bulb is removed. If a detector doesn't work, recheck all connections and the wiring to that detector unit.
3. If the alarm bell rings when you first turn the unit on, look for a break in the series wiring of the detectors. Short out each detector in turn at the end of the wiring in the control unit to determine which circuit is open.

LEARN basic electricity THE EASY "PICTURE BOOK" WAY!



Just Released: The fabulous **ILLUSTRATED Training Course** now used by the U. S. Navy!

You Learn by Pictures

Over 25,000 Navy trainees have already learned Basic Electricity this easy, "Picture Book" way! Now, for the first time, YOU can master the basics of Electricity with this same "Learn-by-Pictures" training course! Over 900 simple, easy-to-understand drawings explain every section—these "teaching" pictures actually make up more than half the entire course! No other Basic Electricity course in America uses this revolutionary illustrative technique! You learn Basic Electricity faster and easier than you'd ever dream possible!

A Complete Idea on Every Page

Here's how this easy, illustrated course works: every page covers one complete idea! There's at least one big illustration on that same page to explain it! What's more, an imaginary instructor stands figuratively at your elbow, doing "demonstrations" that make it even easier for you to understand. Then, at the end of every section, you'll find review pages that highlight the important topics you've just covered. You build a thorough, step-by-step knowledge at your own pace—as fast or as slow as you yourself want to go!

Everyday English—A Course Anyone Can Understand

Sponsored by the Navy to turn out trained technicians in record time, this modern course presents Basic Electricity in a simple way that everyone can grasp—regardless of education! Every phase is made instantly clear—explained in plain, down to earth English—with hundreds of easy-to-understand illustrations to help you!

5 Complete Volumes

Volumes 1 and 2 of this outstanding illustrated course cover DC components and circuits; Volumes 3 and 4 cover AC components and circuits; Volume 5 covers AC and DC motors and machinery.

Home Study Without Correspondence

This course is so different, so complete—there's no need for the usual letter writing, test taking, question and answer correspondence! You learn at home—at your own pace!

10 Day Examination—Money Back Guarantee

Send today for this exciting new Basic Electricity training course—you risk nothing! When you receive the 5 volumes, examine them in your own home for 10 full days. If, at the end of that time, you're not completely satisfied, simply return the books to us and we'll gladly refund your full purchase price! Total cost for the 5-volume course is only \$9.00! In Canada, prices approximately 5% higher.

ORDER TODAY!

JOHN F. RIDER PUBLISHER, INC.
480 Canal Street, N.Y.C.

Please RUSH me.....sets of "Basic Electricity" @ \$9.00 per set. I understand that I may return the books within 10 days and receive a complete refund of my full purchase price.

Name

Address

City & State

wire from the second detector to either wire from the third detector, and continue on this way until all detector units are connected, except the second wire from the last detector. This last wire connects to terminal 4 on the junction block (Fig. 3). As an aid in trouble shooting later, label the two wires from each detector by the location of the detector they come from. Use at least size 18 copper wire when connecting detector units to the alarm units (plastic-covered two-conductor cord used for small appliances and lamps or bell wire are both ideal). Hold wires in place with insulated saddle staples.

To run a wire from the master alarm unit or a detector mounted on the wall, drop a plumb line from the spot on the wall where the wires are to emerge and temporarily mark the quarter-round at this point. Pry quarter-round away from the wall molding at the floor, and drill a locating hole behind the quarter-round through the floor into the basement at the point determined by the plumb line. At the locating hole in the basement, drill a vertical hole up from the basement into the center of the wall. Tie a short length of furnace chain or other weight on the end of a piece of stout string and drop the weight through

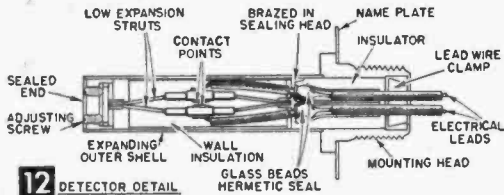

12 DETECTOR DETAIL
Internal construction of Detect-A-Fire thermostat unit.

the hole in the wall and allow it to drop. With luck it will drop through the hole into the basement. If it does not, run a piece of stiff wire bent in an S-shape up from the basement. Twist the wire for several revolutions and pull it out. The string should be twisted around the wire and come out with it. Tie the end of the wire to the string and have someone pull on the string while feeding the wire into the hole in the basement.

The Detect-A-Fire thermostatic units are available in two different styles. Style 7020-1 for home use comes with a mounting base that mounts the detector unit parallel with the wall (A and B in Fig. 1 and Fig. 14). The type 7120 units (C in Fig. 1 and Fig. 14) are vertically mounted and intended for use where explosion-proof wiring is desired. They are threaded on the end to fit 1/2-in. 14 IPS threads in standard electrical fitting boxes. They will protrude approximately 4 in. from the mounting surface. If you want, you can build a guard around either unit you use which protects it from being hit but also allows free air circulation. You may paint the frame of the 7020-1 units to match your wall but do not paint the stainless steel tube portion as this affects its calibration and sensitivity.

With the wiring completed, check the operation of the complete system by following procedure outlined in Table C.

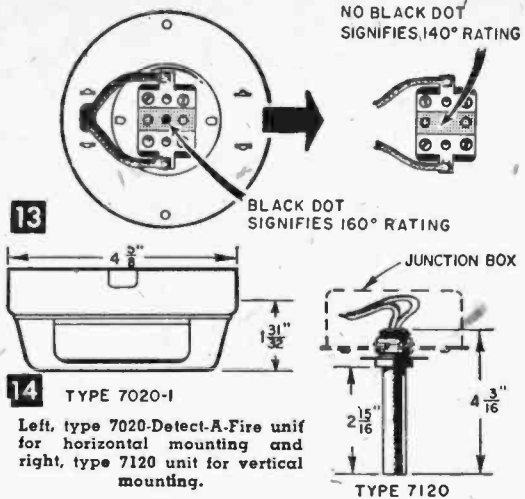

14 TYPE 7020-1
Left, type 7020-Detect-A-Fire unit for horizontal mounting and right, type 7120 unit for vertical mounting.

The master alarm unit may be left on 24 hours a day or operated at any other time interval desired. Finally, to make sure this fire "watchdog" is always alert, follow the test program outlined in Tables A, B and C. It's also a good idea to place a card inside the master alarm control unit, on which you can keep a record of the inspection dates.

Farm Installations. If you want to mount detector units in a barn or other out-building, two wires must be run between the out-building and the home, but these wires must not be combined in ducts with 115 or 220-volt power wiring. Instead, separate #12 copper or #10 aluminum overhead wires, or buried #14 or larger lead-covered cable or trenchwire, should be used. If you use overhead wires and must cross power lines, they should pass under the power lines. If open-type knob and tube power wiring has been used, the detector circuit wires should not run any closer than 4 in. to the power wires. Where these alarm circuit wires enter buildings, use the same type porcelain insulators and regular service type entrance fittings used for power lines.—

END

Pencil Clip Secures Screw to Driver

A SCREW-HOLDING screw driver is easily made by adding an ordinary metal pencil clip to the driver, as shown, so that it will hold the head of the screw while it is being placed

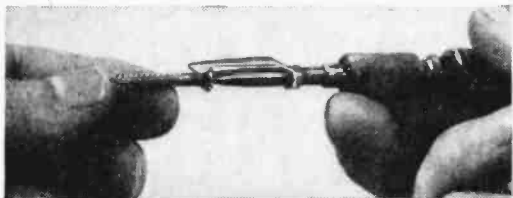

in position for driving. It will probably be necessary to bend the arms of the clip with pliers so that it will grip the smaller driver shaft. Pull clip back out of way when not in use.—K. M.

A midget IF transformer can (inset) housed the original phono surface noise and scratch filter, but other more common types of tin containers can be used. To use filter, merely plug unit into line between record player and amplifier or radio phono jack.



Noise Filter for Record Playing

RECORDS, both old and new, frequently suffer a common disease—surface noise. Here's a filter that should help to cut down that distracting scratching, so that you can enjoy even those old favorite records made before the advent of electronic recording.

This record filter plugs into the input line of the phono amplifier (Fig. 1) so that in most instances no internal circuit changes are required, either at the record player or amplifier. The original unit was housed in a miniature IF transformer can (Fig. 1A), but any small metal container may be used.

Drill a $\frac{1}{32}$ -in. hole in one end of the can; this hole will be just large enough for you to insert the neck of the ICA-type phono plug shell. Solder the shell to the can. If the housing is made of aluminum, first "tin" the areas around the $\frac{1}{32}$ -in. hole with aluminum solder. You can then solder the shell to the aluminum with regular lead/tin alloy radio solder.

Drill a $\frac{3}{8}$ -in. hole in the opposite end of the can, along with two $\frac{1}{8}$ -in. holes for mounting an ICA-type phono jack. When screwed down with $\frac{1}{4}$ x 4-40 machine screws, the jack shell is automatically grounded to the metal container.

The filter network (Figs. 2 and 3) consists of two 470k (470,000) ohm $\frac{1}{2}$ -watt resistors and two ceramic capacitors with an identical capacity of 100 to 500 mmf each. Where surface noise is only slight, use capacitors of 100 mmf to 250 mmf. For old, scratched discs, use capacitors of about 500 mmf. The larger capacitors will somewhat increase the bass response of records, and suppress the highs, but at least you'll be able to hear both bass and treble far better with the annoying surface noise suppressed.

If you are very ambitious, substitute a pair of

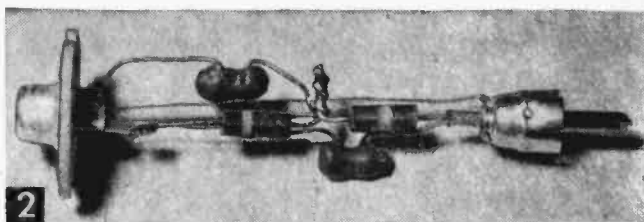

The noise filter consists of six inexpensive radio components listed in Fig. 3.

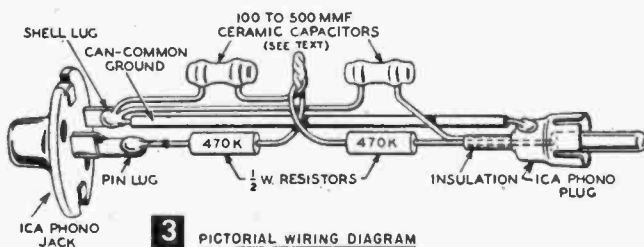

3 PICTORIAL WIRING DIAGRAM

MATERIALS LIST—RECORD NOISE FILTER

- 1 small friction lid can, or IF transformer shell
- 1 ICA type phono plug
- 1 ICA type phono jack
- 2 470k (470,000) ohm, $\frac{1}{2}$ -watt composition resistors
- 2 fixed ceramic capacitors or adjustable trimmers (see text)
- 2 $\frac{1}{4}$ x 4-40 rh machine screws and nuts

adjustable mica trimmer capacitors with a range of about 100-500 mmf for the fixed ceramic types. Then with a screwdriver, you can adjust the capacitances to suit the condition of the record.

When wiring up the filter, be sure the resistor and capacitor lead to the phono-plug pin does not accidentally ground to the shell since this would render the phono inoperative. A short length of radio "spaghetti" or other insulation will prevent this.—T. A. BLANCHARD.

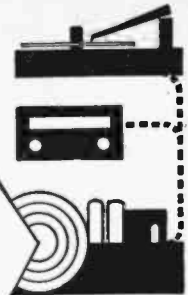

HI-FI SOUND REPRODUCTION

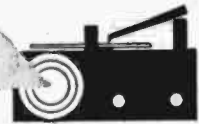

CONVENTIONAL SOUND REPRODUCTION

High-fidelity sound reproduction, involving a sound source (phonograph), tuner, amplifier and speaker, gives the full sound picture. Sound from conventional equipment is clipped and distorted in comparison.

What to Look for in Buying Hi-Fi

By JOHN L. WATKINS

AMERICANS have been quietly spending nearly \$100 million for high-fidelity sound reproduction systems with little urging from magazine and radio ads. Performance is what sells hi-fi, and the news has travelled, from ear to ear.

Anything worth hearing, from bebop to Brahms, sounds better on hi-fi. Even the ball games have more "presence." The crowd-sounds, as well as the announcer's voice, are right in the room with you. One man with a deluxe set likes Spike Jones records. Every yawp and burp comes out beautifully, he says.

Another nice thing about hi-fi is its price tag. When you buy the electronic components from radio parts houses, your dollar goes for performance, not fancy cabinetry. For \$85-150 you can get a "hi-fi" package deal for mounting in your own amplifier and baffing cabinets. The units simply plug together, and you can line them up on a bookshelf or enclose them in mahogany.

Now that the phrase has caught on, more and more manufacturers are calling their radio-phonographs "high-fidelity." Some of them are and some aren't. How can you tell the difference?

A real hi-fi "package" will have a magnetic phonograph pickup, wide-range, amplifier co-ax or separate woofer and tweeter (treble) speaker for mounting in an acoustically designed baffle and an FM radio, if it has a radio section. Each of these components can be evaluated according to certain standards that we'll explain later. In any event, it's best to examine the

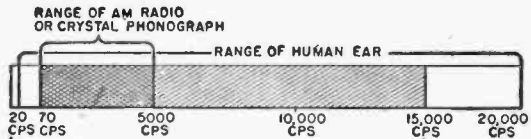

1 RANGE OF FM RADIO (MINIMUM FOR HI-FIDELITY)

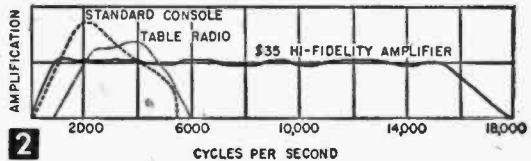

2

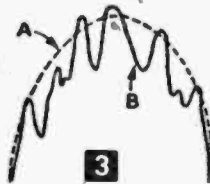

3 Above, an ordinary big speaker console overemphasizes bass notes. A table radio has a small speaker, overemphasizes treble. Both have "cut-off" just under 6,000 cps. Hi-fi amplifier renders faithfully to 15,000 cps. Some more expensive hi-fi amplifiers have "flat response" to 100,000 cps, far beyond the range of the human ear. Left, ordinary amplifiers "Smooth off" (dotted line A) secondary vibrations (B) of a note. It is these harmonics of overtones that give a musical instrument its quality.

units and get the performance figures on each one. A genuine hi-fi dealer will be glad to give them to you. Literature and catalogs from manufacturers listed in the tables accompanying this story also will be of some help.

The human ear is sensitive to sound frequencies from about 20 cycles per second (cps) to 18,000 cps (Fig. 1). Early sound reproduction

PROGRESSIVE SPEAKER EXPANSION

a new approach to personalized listening . . .

by *University*

A modest budget need no longer limit the quality and caliber of your hi-fi aspirations. University offers, for the first time in audio history, a tremendous selection of uniquely designed speaker and network components so brilliantly conceived and executed that it is now possible to develop your loudspeaker system in successive, relatively inexpensive stages . . . until what you have meets your listening requirements.

Progressive Speaker Expansion by University makes it possible for you to buy a speaker today in terms of the system you want tomorrow! You are thus able to devote your present budget primarily in the initial selection of quality amplifying and program source equipment which cannot be economically altered or substituted at a later date. P-S-E makes your speaker choice an easy one. Depending upon your goal and space limitations, there are numerous University speaker systems that can be started at minimum cost with immediate listening satisfaction.

start planning today . . .

the *University* way!

- Buy good amplifier and program source equipment which will do justice to your eventual University speaker system . . . and start with one of the versatile top quality speakers or combinations recommended in the P-S-E chart.*
- Build up to a deluxe speaker system with University components so designed that speaker and network can be easily integrated for better and better sound reproduction—without fear of obsolescence.
- Own a P-S-E speaker system which meets hi-fi quality standards from the very beginning—and reach the highest standard of all—YOUR OWN.



*Write desk 56 for the University P.S.E. chart.

University Loudspeakers

80 SOUTH KENSICO AVENUE, WHITE PLAINS, NEW YORK

INC.

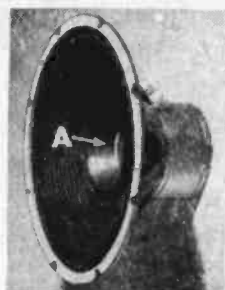
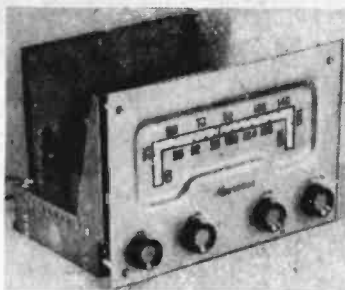
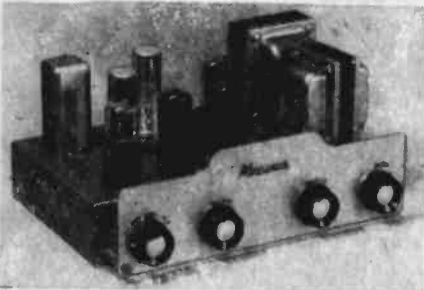

Meissner 10-watt, hi-fi amplifier, with frequency response ± 1 db. from 20 to 20,000 cps, has controls for (left to right) input, volume, treble attenuation and bass boost mounted on the chassis. This model also has record compensation. This 8-tube Meissner AM-FM tuner (center) has a flat frequency response of from 20 to 20,000 cps. The small center cone (A) of this Electro-Voice 12-in. speaker attaches to a single voice coil, produces high-frequency notes accurately.

and recording equipment (in the 1930's) was reproducing the sound range up to only 6,000 cps and that rather poorly. Bass notes were much weaker in reproduced music than they were in "live" sound. Performance curves showed resonant peaks and valleys. Some notes "boomed" while others were muted because the equipment was friendlier to some frequencies than others and could not reproduce all notes equally or in a linear manner.

Today, however, some of the new amplifiers will amplify a range six times the range of the human ear with an error of only one decibel—excellent linearity. (In technical jargon this is known as frequency response, expressed as ± 1 db. from 10 to 100,000 cps.)

FM radio, invented by Major Armstrong in the

'20s, was utilized to bring the full sound range to radio. Magnetic phono pickups, replacing the crystal pickups still used in ordinary radio-phonographs, were designed to respond to frequencies up to 20,000 cps without the inherent distortion introduced by the crystal cartridge. New speaker systems brought the extreme bass and treble notes up to audible levels.

Better tubes and record materials were developed and recording techniques and circuitry improved. Record players were built to finer tolerances to eliminate high and low frequency noises—tube noise or hiss, record scratch, turntable rumble, "wow" and a-c hum.

By 1947 the major problems had been solved and the designers were free to clean up details and add refinements. High-fidelity sets did not immediately appear on the market, however, even in "quality" consoles. It is still something special. If you walk down to Chip and Dale's Furniture Mart and ask for a hi-fi set you are likely to get a blank stare. If you buy a radio from them you'll probably get a beautiful hand rubbed cabinet and inside the conventional, non hi-fi equipment. Hi-fi in a quality console is now available, but it is expensive.

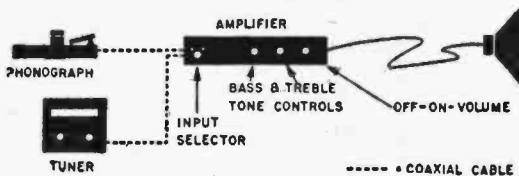

4 PREAMPLIFIER & CONTROLS IN AMPLIFIER

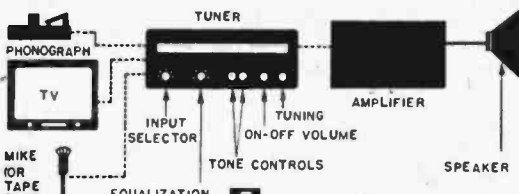

5 PREAMPLIFIER & CONTROLS IN TUNER

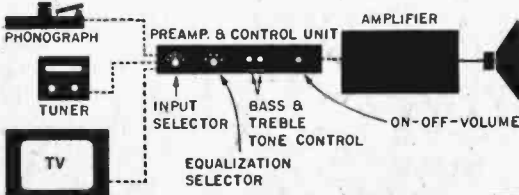

6 SEPARATE PREAMPLIFIER & CONTROL UNIT WITH TV SOUND

TABLE A—CHECKLIST FOR HI-FI

A Genuine Hi-Fi Package Will Have the Following:

1. Magnetic phonograph pickup.
2. Wide range amplifier (± 2 db. from 40-15,000 cps (or better). Harmonic distortion of 3% or less.
3. Speaker or speakers enclosed in an acoustically designed baffle.
4. FM radio if it has radio section.

RECORD PLAYERS

The following play the three kinds of records automatically and are well-made enough for Hi-Fi: (Prices are less magnetic cartridge and needle.)

Garrard RC 80, \$45 Webcor 127-27 HF, \$44

V-M Model 936 HF, \$45

The Garrard Model "T," \$28, plays three-speeds (Records are changed manually.)

PHONOGRAPH CARTRIDGES

The following have Hi-Fi response and linearity. All require equalized preamplification normally found in Hi-Fi equipment:

General Electric "triple play," RPX-050, \$8.20, has dual sapphire tip; RPX-052, \$23, is diamond-tipped for 33 $\frac{1}{3}$ and 45 rpm and sapphire for 78 rpm. Pickering 120 series, single play, sapphire, \$10, diamond \$25.

Pickering 260, turnover cartridge plays all records, diamond tips on back-to-back cartridges, \$60.

Audax Polyphase comes with two interchangeable sapphire needles, \$15.

Clarkstan RV-201, single play, sapphire needle, \$15.

TABLE B—AMPLIFIERS

| Model & Make | Power In Watts | Frequency Response & Harmonic Distortion | CONTROLS | | | | Special features | Tubes | Price |
|--------------------------|----------------|------------------------------------------|--------------------------------------------------------------------|-------|--------------------|-----------------------------------|---------------------------------------------|-------|-------|
| | | | Input Selector | Tone* | Record compensator | Other | | | |
| Grommes LJ 2 | 8 | ±1 db. 20-20000 cps 1½% @ 8 watts | 2 pos. | fair | no | Input selector on rear of chassis | Built-in preamp | 5 | \$ 38 |
| Bogen DB 10-1 | 10 | ±1 db. 30-18000 cps 3% @ 10 watts | 3 pos. | good | no | | Built-in preamp | 5 | \$ 55 |
| Bell 2122 B | 10 | ±.75 db. 20-20000 cps 3% @ 10 watts | 3 pos. | good | no | | Built-in preamp | 6 | \$ 50 |
| Radio Craftsmen C-400 | 10 | ±1 db. 15-20000 cps 1% @ 10 watts | Basic Amplifier—To be used with controls and preamp on tuner | | | | | 5 | \$ 43 |
| Pilot AA 903 | 10 | ±1 db. 15-40000 cps 1% @ 10 watts | 3 pos. | good | 4 pos. | | Built-in preamp | 7 | \$ 70 |
| Scott 99-A | 10 | "flat" 20-20000 cps 0.8% @ 10 watts | 4 pos. | good | 9 pos. | Adjustable loudness control | Built-in preamp plugin for noise suppressor | 6 | \$ 98 |
| Newcomb A 104 R | 12 | ±1 db. 20-20000 cps 2% @ 12 watts | 4 pos. | good | 3 pos. | Loudness control | Separate control panel. Built-in preamp | 6 | \$ 80 |
| Bell 2200 | 20 | ±0.2 db. 20-20000 cps 0.3% @ 20 watts | 6 pos. | good | 5 pos. | Loudness control | Built-in preamp | 7 | \$ 97 |
| Stromberg Carlson AR 410 | 10 | ±1 db. 20-20000 cps 1% @ 10 watts | 3 pos. | good | 2 pos. | Loudness control | Built-in preamp | 6 | \$ 80 |
| General Electric A1-300 | 10 | ±2 db. 30-15000 cps 1% @ 10 watts | Basic Amplifier—Designed to work with separate preamp control unit | | | | | 5 | \$ 47 |
| Knight 93SX321 | 24 | ±0.75 db. 20-40000 cps 1% @ 24 watts | 3 pos. | good | 3 pos. | | Built-in preamp | 6 | \$ 80 |
| Hallicrafters A-84 | 10 | ±1 db. 9-100000 cps 0.14% @ 10 watts | Basic Amplifier—To be used with controls and preamp in tuner | | | | | 5 | 100 |

*fair—Bass boost and treble attenuate good—Boost and attenuate in both bass & treble

Prices in both tables subject to change.

If you buy the units separately, ask the dealer, manufacturer, or mail order supply house with whom you're doing business to show you performance figures and special refinements and features to be sure that you are getting the most for your money. Individual units can be purchased as your budget allows (Table A).

Amplifiers—An amplifier is the heart of the hi-fi system. Combined with good pickups, tuners, speakers and baffles it will reproduce "live sound." They are rated by their frequency response, power output and distortion and according to their controls.

The frequency response of an amplifier tells you what part of the sound spectrum it amplifies as well as how accurately it does the job. Most ears are satisfied with a range of 40-15,000 cps and a linear accuracy of ± 1.5 or ± 2.0 decibels (db.) in that range (Fig. 2). Of course, if the amplifier goes down to 20 cps and up to 18,000 cps, so much the better. Sounds beyond that range are inaudible. Likewise a linearity of ± 1.0 db. is better than ± 2.0 and ± 0.5 is even better, but anything inside ± 1.5 db. is very good.

Distortion in amplifiers (Fig. 3) is expressed in both harmonic and intermodulation distortion by a per cent figure. Harmonic distortion of 3% and intermodulation distortion

of 8% are the allowable maximums in true hi-fi equipment (Table B).

An average volume level for most living rooms is three watts or less. Ten-watt volume would drive you out of the house and 40 watts would bring complaints from neighbors halfway down the block. Why, then, have 20 or 40-watt rigs?

It isn't all horsepower mania. Music and speech contain sound peaks which occasionally go far above the average level. Amplifiers distort when they work above their rated output. The extra power enables an amplifier to handle the peaks without distortion. Eight or 10-watt power will handle most; 15 or 20 get practically all.

Controls—You want a good set of controls for your system, of course. But how many, what kind and where should they be located?

They may be on the amplifier, on the tuner or in a small separate unit. Generally you get the most for your money if you buy them on the amplifier (Fig. 4), but having them on the tuner or in a separate unit may be convenient (Fig. 5).

The controls you need are for volume and tone

TABLE C—TUNERS

| Make and Model | AM | FM | AFC | FM Sensitivity | Cathode follower output | Built-in Preamp | Tone Controls | Record compensator | Selector Switch | Tubes | Price |
|---------------------------|----|----|-----|----------------|-------------------------|-----------------|---------------|--------------------|-----------------|-------|-------|
| Knight 727 | X | X | — | Local | — | — | — | — | 3 pos. | 8 | \$ 53 |
| Meissner 8C | — | X | — | Local | — | — | — | — | — | 8 | \$ 64 |
| Pilot AF 723 | X | X | X | 10 mv. | yes | — | — | — | 4 pos. | 8 | \$ 80 |
| Pilot FM—607 | — | X | X | 5 mv. | yes | — | — | — | 3 pos. | 8 | \$ 60 |
| Bogen R-604 | X | X | X | 5 mv. | — | — | — | — | 4 pos. | 8 | \$ 97 |
| Radio Craftsmen C-900 | — | X | X | 1½ mv. | yes | — | — | — | — | 11 | \$ 99 |
| Stromberg Carlson 4 SR 01 | X | X | X | 5 mv. | — | — | — | — | 3 pos. | 10 | \$140 |
| Hallicrafter ST-83 | X | X | — | 7 mv. | yes | yes | good | — | 4 pos. | 12 | \$130 |
| Radio Craftsmen C-800 | X | X | X | 5 mv. | yes | yes | good | 3 pos. | 6 pos. | 15 | \$160 |
| Radio Craftsmen C-10 | X | X | X | 5 mv. | yes | yes | good | — | 4 pos. | 12 | \$132 |



Installing a "Package" High-Fidelity System

A For this Altec Lansing package hi-fi system, only a screwdriver is needed to assemble the individual units. Shown left to right: Webcor 127HF 3-speed record player with plug-in head; Altec Lansing 303C AM-FM tuner; Altec Lansing A333A power amplifier; Altec Lansing 601A duplex speaker; foreground, connecting cables and capacitor crossover.

B GE variable reluctance pickup plugs into record player arm. These pickups have a very low signal voltage output and require a separate pre-amplifier in some instances. Ceramic crystal pickups developed by Sonotone claim wide frequency response, moderate cost, and no preamp requirements.

C A commercial or homemade cabinet may be used to house tuner, amplifier and record changer mechanism. Old radio cabinets may be modernized for the purpose.

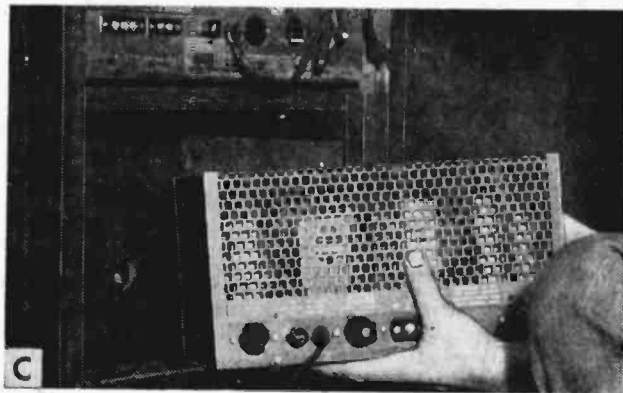

control and input selection (Table B). If you want to get the best out of your records you will also want a control for record equalization.

The less expensive amplifiers have a volume control just like the one on your radio. "Loudness control" is a refinement that some people find worthwhile. At low listening levels your ear is less sensitive to very low and very high notes. A loudness control boosts these frequencies up so that your ear can hear them in the same relative strength as at louder levels.

The simplest tone control is the single treble attenuation type. Turn it and the high notes begin to fade; turn it back and they reappear. This is inadequate for hi-fi. An "adequate" system would have treble attenuation in one control and bass boost in another. A "complete" tone control system has both boost and attenuation in both the treble and bass controls.

Recording engineers reduce the bass volume and "emphasize" the treble. If they didn't, the

loud bass notes would drive the cutting needle into the next groove. Also, emphasis of the high frequency notes is required to raise the level of these notes above the inherent high frequency record noise. An "equalization network" boosts the bass and reduces the treble notes to their proper levels. The difficulty is that there are nearly as many "equalization curves" as there are record companies. The best control systems provide as many as nine positions of equalization. If you want to add equalization to your system get the inexpensive plug-in "record compensator" for the particular cartridge you are using.

An input selector will enable you to switch from radio to phonograph to TV sound, tape, microphone or whatever else you may want to play through your amplifier, without going into the chassis to switch plugs. Check to see that it is in a convenient place and has enough inputs.

Tuners—If you already have a good AM-FM table radio you can have it adapted to plug into

D Units are interconnected with plug-fitted cables, and wires which tie down to screw terminal strips. Package units require just one assembly tool—a screwdriver.

E Speaker shown is a co-ax or duplex type with a large cone-type woofer (bass) and a small horn-type tweeter (treble) reproducer built into the larger unit. To couple the two units to the output of amplifier, crossover network in box at left is used.

F To exclude vibrations and echo-effect, speaker baffles are dampened with noise-deadening materials. Note sides of cabinet have been lined with fiber glass or Celotex bats as used for home insulating purposes. Triangular fiber glass panel "reflects" rear cone vibrations through rectangular port (P).

G Availability of knocked-down, unfinished cabinets and speaker enclosures allow the high-fidelity fan to "roll his own" if commercial cabinets are beyond his pocketbook. Speaker and arm-chair cabinets shown are sold separately.

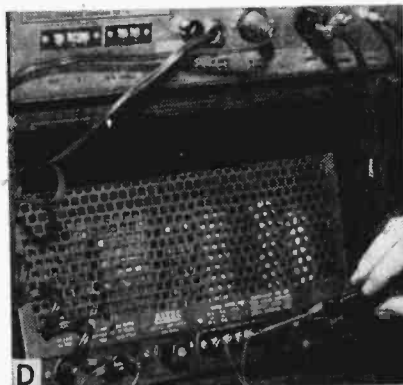
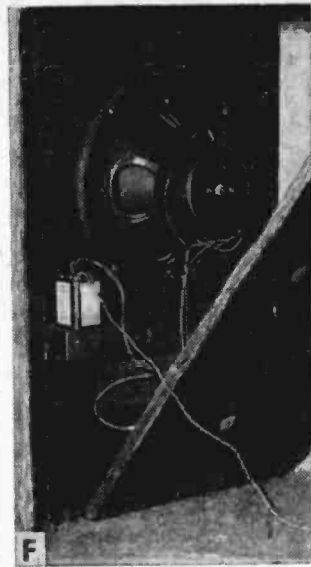

your amplifier very cheaply. Its FM section will probably give you a satisfactory hi-fi source. However, FM transmission, like TV, is short-ranged. Your receiver will need more and more sensitivity as the station distance increases. For distant reception an outside antenna is vital. Most broadband TV antennas work very well on FM.

A good FM tuner (Table C) should have the same range (up to 15,000 cps) and linearity as your amplifier. In addition, the more expensive tuners have some refinements which you will want to consider. These are improved sensitivity, less distortion, tuning eye, automatic frequency control (AFC), amplifier controls and built-in preamplifier.

Sensitivity will be important to you if you live in a fringe area—beyond 25 miles or so for stations of average power. Sensitivity is stated as the signal strength in microvolts necessary for static-free reception. Sensitivity increases as the microvolts decrease; hence, for fringe area recep-

tion a receiver with a sensitivity of 5 mv or less is required, while for a receiver in the immediate vicinity of a transmitter a sensitivity of 40 mv may be adequate.

Tuners without AFC tend to detune as they warm up, and this makes them sound "fuzzy." Some of them may need several tunings during warm-up. Temperature-compensated parts reduce this drift but AFC will eliminate it. If there is a weak station close to a strong one on the dial AFC may tune out the weak one in favor of the strong one. Some sets provide an AFC disable switch so you can tune the weak one manually.

Some tuners contain a preamplifier and all the controls for the amplifier (Fig. 6). This makes good sense. All the controls will be on a single panel, and you can put the amplifier in any convenient nearby place, or even across the room if the tuner uses a "cathode follower" output. Be sure the tuner has all the controls you want.

Cartridges and Needles—The phonograph car-

This Jensen 15-in. coaxial speaker costs \$77.91. It has a separate tweeter for treble and a built-in crossover network.

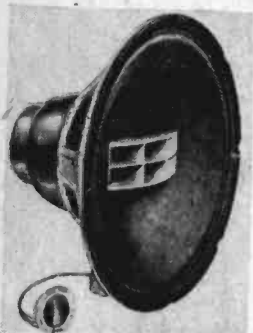

TABLE D—SPEAKERS

| Make and Model | Power In Watts | Cone Diameter | Voice Coils | Provision for high frequency | Remarks | Approx. Price |
|---------------------------|----------------|---------------|-------------|-----------------------------------|----------------------------------------------------------------------|---------------|
| General Electric S 1201 A | 25 | 12" | 1 | Throated cone | Response 50-13,000 cps. | \$20 |
| University Diffusicone-12 | 30 | 12" | 1 | Small cone inside large one | Response 45-13,000 cps. | \$26 |
| Electro-Voice SP 12-B | 18 | 12" | 1 | Small cone inside large one | Response ± 6 db. 35-13,000 cps. | \$29 |
| General Electric A 1-400 | 25 | 12" | 2 | Coaxial tweeter inside large cone | Response ± 5 db. 40-15,000 cps. | \$41 |
| Jensen H-222 | 25 | 12" | 2 | Coaxial tweeter inside large cone | Special tweeter horn spreads treble in wide angle | \$53 |
| Altec-Lansing 602-A | 20 | 15" | 2 | Coaxial tweeter inside large cone | Response 30-22,000 cps. | \$114 |
| Stephens 206 AX | 20 | 15" | 2 | Coaxial tweeter inside large cone | Response 30-18,000 cps. | \$122 |
| Altec-Lansing 604-C | 35 | 15" | 2 | Coaxial tweeter inside large cone | Response 30-22,000 cps. | \$156 |
| Electro-Voice Regency II | 25 | 15" | 2 | Tweeter mounts separately | Mounted in specially designed "klipsch" enclosure—Response 30-16,000 | \$304 |

tridge, or pickup, changes needle vibration into an electric signal. Some of the latest crystal pickups have a frequency response up to 10,000 cps, but most of them cut off at 4-7,000 cps. All genuine hi-fi phono systems use magnetic cartridges which have a "flat" response to 15,000 or 20,000 cps when used with an equalized preamplifier. Since magnetic cartridges produce a weak signal they require preamplification before being fed into the main amplifier.

Pickup cartridges come with single or dual needles and may be diamond- or sapphire-tipped. The 33 $\frac{1}{3}$ and 45 rpm records have "microgrooves" and require a smaller needle tip than 78 rpm records. If you want to play both kinds, get a cartridge like the G.E. "triple-play," which has a needle-selector knob, or a turnover cartridge like the Pickering.

Needles wear out of shape with use and worn needles damage the fine record grooves. Diamond tips wear about 10 to 30 times as long as sapphire and they cost from 2 $\frac{1}{2}$ to 8 times as much. Sapphire tips are satisfactory if you inspect them regularly and change them when worn.

Record Players—A good record player should include provisions for playing 33 $\frac{1}{3}$, 45 and 78 rpm records, and should turn the record at the proper speed and so smoothly that no unwanted vibrations reach the pickup needle. Desirable features for a record changer to be used in a hi-fi system are; a four-pole motor for minimum wow, weighted turntable to reduce wow and rumble, muting switch, and needle pressure adjustment.

Speakers—Hi-fi designers privately admit that speakers are now the weakest link in the system. Even inexpensive amplifiers have a flat response of ± 1 db., but ± 5 db. is considered good for a hi-fi speaker. Ordinary speakers may have an irregular response as high as ± 20 db.

There are three types of hi-fi speakers: extended range speakers with a single voice coil and "woofer-tweeter" combinations (Table D). It takes a big cone—12 in. diameter or better—to do full justice to the bass notes. But a big cone is too heavy and slow-moving to reproduce the

treble region properly.

Extended range speakers are cheaper because they use only one voice coil. They produce the treble notes by use of a special cone. Some have throated cones and others have a small specially-shaped cone in the center.

The present woofer-tweeters consist of at least two separate speakers. A coaxial-type speaker has the tweeter mounted inside the woofer. The woofer-tweeters require a crossover network to keep the bass notes from damaging the tweeter. They usually are built into coaxial speakers.

A separate 12-in. speaker for bass, with an 8-in. treble, in a suitable baffle, is preferred by many over the single unit woofer-tweeter.

The Electro Static speaker is a really choice hi-fi unit. It employs no cone or voice coil.

Enclosures—Speakers are much more affected by variables than the other units. With a happy choice of enclosure and room position a mediocre speaker may perform very well. A poor choice of the same factors can handicap a good speaker.

The speaker cone generates sound by vibrating against the air. When the cone moves forward it radiates a wave of compression. At the same time a wave of decompression leaves the rear of the cone. If the speaker is not baffled, these waves curve into each other and tend to cancel out, especially at low frequencies. The simplest enclosure, the infinite baffle, is designed to keep the front and rear waves apart. A speaker mounted in a wall, a closet door or a large, solid box (eight cubic feet or better) will perform much better than an unmounted speaker. Other designs—folded horns, bass-reflex, cabinets, etc.—use principles of air-loading and resonance to strengthen response in the bass region.

Maintenance—Hi-fi is not as complicated and delicate as it sounds, nor is it apt to be a maintenance headache. Except that it has two power supplies instead of one, many a combination is only slightly more complicated than an ordinary radio-phonograph. Hi-fi units have fewer delicate circuits and high voltage. If you do have trouble, unplug the unit and take it to be serviced.

The controls of this Scott amplifier have most of the hi-fi refinements: four position input selector (A) for phonograph, radio tuner, tape and TV; two equalization knobs (B) giving nine curves; bass (C) and treble (D) tone control, and loudness control (E). This Electro-Voice speaker system and cabinet is large and expensive (over \$300) but has top sound quality.

Woofer (A) and tweeter (B) are separate units and box (C) is a crossover network that keeps low frequencies out of the tweeter.

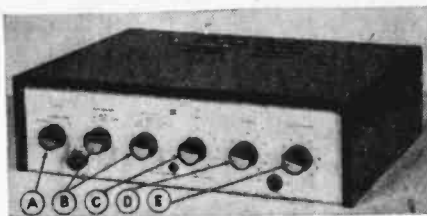

How and Where to Buy Hi-Fi

You may not have the ready cash to buy a complete system at one crack. Since hi-fi breaks down into a number of separate units, purchases can be made piecemeal. For example, you may have a radio with a good 3-stage amplifier and dual speakers. The record player may be an old 78 R.P.M. manual or automatic type.

The amplifier and speaker system may be far superior to a low cost so-called "high fidelity" job. Replacing the old record player with a modern 3-speed unit with either a reluctance magnetic pickup, or wide range ceramic crystal unit may give you all the performance you desire.

Old amplifiers and speakers are often capable of reproducing much more than it was possible to record on the shellac-pressed records made a decade ago. Actually, the modern vinyl LP and 45 records, featherweight pickups and current recording techniques account for much of the quality you get out of a phonograph record. Of course, this assumes the amplifier is in top working condition and speaker cones are not warped or torn.

Remember that a great deal of stress is placed on the frequency range of hi-fi systems. Ask yourself this question: Do I want just crystal-clear, undistorted music the family can enjoy, or should I pay for scientific ethereal charts and figures?

For example, the average human can barely hear either a 50 cycle note or 10,000 cycle note. Anything higher would be of interest only to a dog. It is nice to know that the frequency range of some amplifiers extends to supersonic frequencies. However, a good 7 or 10-watt amplifier of the British Williamson type, ultra-linear design, or the resistance-coupled Inverse Feedback type can please the severest critic if it is not overloaded to create distortion, either at the pickup input, or speaker output.

The experimenter can determine at slight expense just how well his partial or complete hi-fi system is working with the aid of inexpensive test records. RCA-Victor has a 12-in. LP record, "Hearing Is Believing" (\$1.00). On this disc both old and new recorded sounds and music have been combined with a narration. Primarily, this record was prepared to show the great improvements made in recent years in the recording industry. However, the frequency range of the hi-fi selections on this disc will help you determine how well your system is performing.

The frequency test record is most helpful in determining the range of your amplifier. Here, there is no music, but merely a series of identified tone signals. A typical frequency record contains sounds ranging from 50 to 10,000 cycles or more, usually created by an audio tone oscillator.

Since percussion instruments are the most difficult to faithfully record and play back, some test records include bells, chimes and cymbals. Various types of whistles may be included, too.

Test records are not always readily available. However many dealers in hi-fi equipment now stock them. Any regular music or exclusive record shop will order them for you since they are listed in the standard catalogs of all the leading record manufacturers such as Columbia and Victor.

Practically all the sounds the human ear encounters fall between 80 and 5500 cycles. Distortion of these frequencies is the nemesis of run-of-the-mine record playing and reproducing devices. You can't expect much more from a \$1.98 phono cartridge and a \$2.98 5-in. PM speaker than distortion.

We suggest that hi-fi apparatus be purchased from component parts specialists. Most of these firms sell by mail and have catalogs and literature on parts, accessories, and complete "package" deals in every price bracket. You can buy as little or as much as your pocketbook will allow without being badgered into taking stuff you neither want nor can afford.

Needless to say, hi-fi has proved a fertile field for many a "sharp" operator who usually operates only on a local basis selling complete outfits, unlike the parts houses who specialize in trade sales to technicians, engineers and radio experimenters rather than the general public.

Firms that may supply literature and technical assistance (if needed) on high-fidelity equipment are:

- Allied Radio Corp., 100 No. Western Ave., Chicago 80, Ill.
- Almo Radio Co., 509 Arch St., Philadelphia, Pa.
- Altec Lansing Corp., 161 Sixth Ave., New York 13, N. Y.
- Burstein-Applebee Co., 1012 McGee St., Kansas City 6, Mo.
- Concord Radio Co., 55 Vesey St., New York 7, N. Y.
- Federated Electronics, 66 Dey St., New York 7, N. Y.
- Harvey Radio Co., 103 W. 43rd St., New York 36, N. Y.
- Lafayette Radio, 100 Ave. of Americas, New York 13, N. Y.
- Newark Electric Co., 223 W. Madison St., Chicago 6, Ill.
- Olympic Radio Supply Co., 1440 W. Olympic Blvd., Los Angeles 15, Calif.
- Radio Ham Shack, Boston, Mass.
- Sun Radio, 650 Ave. of Americas, New York, N. Y.
- Walter Ashe Radio Co., 1125 Pine St., St. Louis 1, Mo.
- Wholesale Radio Parts Co., 311 W. Baltimore St., Baltimore 1, Md.
- World Radio Labs., 744 W. Broadway, Council Bluffs, Iowa

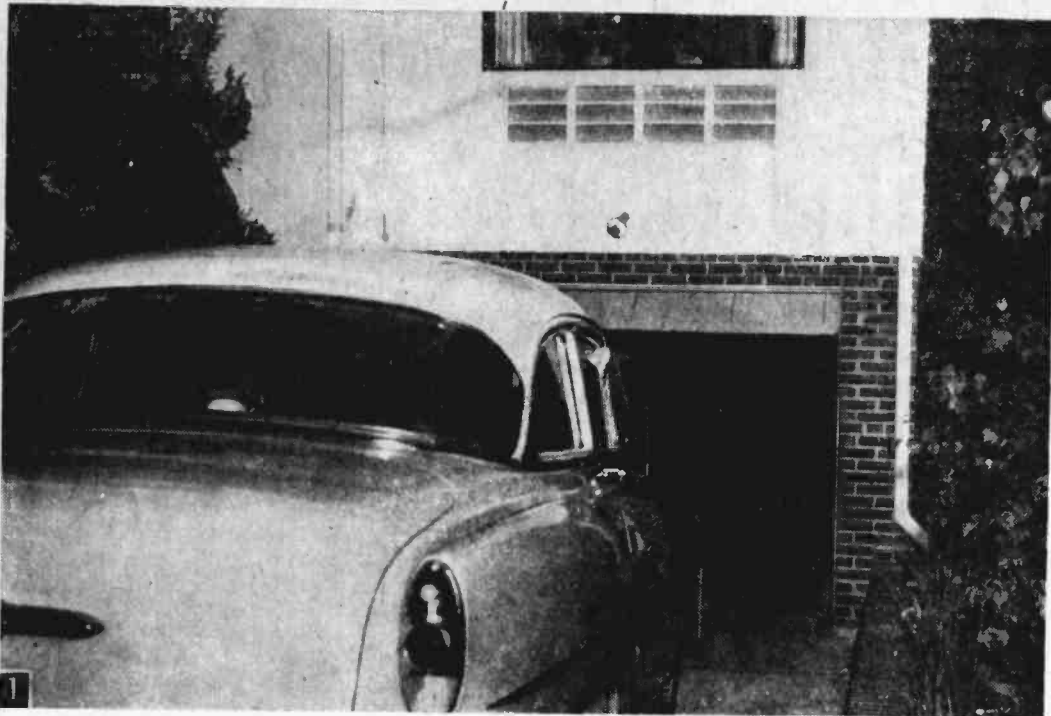

Remote Control for Your Garage Door

Part I. Here's a handy way to control your garage door without leaving your car

WITH all the other electrical gadgets and appliances at your fingertips, why not add one more—an electric motor to raise and lower the door to your garage. There's a "touch" of luxury about your home when you can simply push a button on a post alongside your driveway and the door opens ahead for you to drive in—and you never leave your car. When you drive out in the morning, simply push the button and the door closes again. At the same time the door opens, a back door light flicks *On*. Another switch beside the door or inside the house closes the door after you drive in—or opens it before you leave.

Besides making it easier for your wife to drive the car, get at things stored in the garage or deposit baby carriage, stroller or grocery cart inside, you add up to \$300 to the value of your home.

Nearly any sectional garage door that uses an overhead track and operates with a cable and spring mechanism can be mechanized.

Principal parts of garage door opener installation. Pressing the key switch or inserting shorted phone plug into jack (D) on a post by the driveway, connected to relay control box (C) in the garage starts motor (E) which, through worm reduction (F) and sprocket assembly (G), raises the door by means of chain (H). Door stops motor when it strikes *Up* limit switch (L). After driving in, pressing the button (A) on the control box (C) closes the door which stops when it strikes *Down* limit switch (K). The power supply connects to control box (C) by means of plug (B). Switch in power line cuts off system.

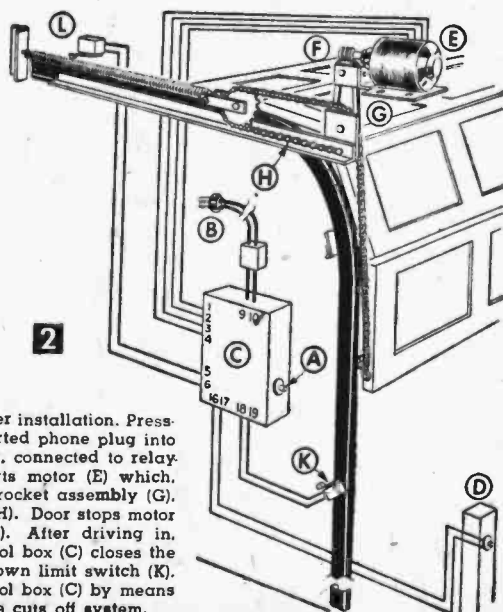
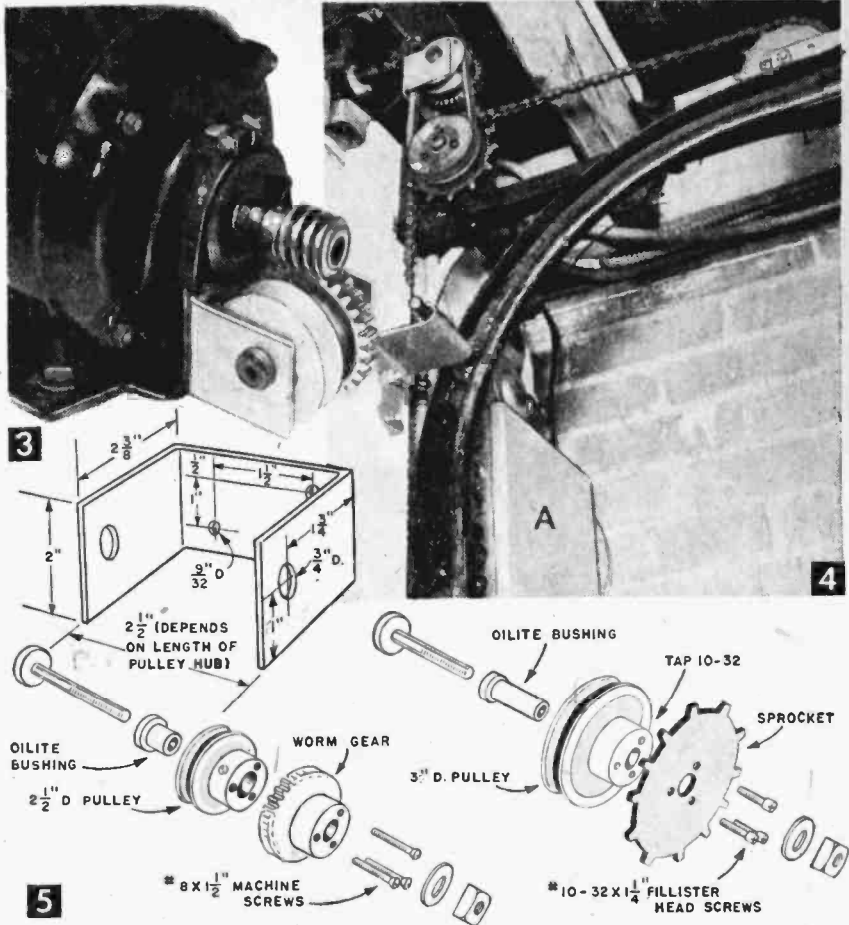

Fig. 3. Speed reducing worm with V-belt pulley and frame, Fig. 4. Speed reduction worm and sprocket chain drive mechanism at top of one side of door. (A) Control box for mounting parts.

Replace one of the spring cables with a bicycle chain driven by a sprocket wheel that in turn is driven by a V-belt and reversible motor (Fig. 4). Install limit switches to stop the door at both the Up and Down positions. A sequence relay in the control box automatically sets the mechanism to reverse operation the next time either the house or driveway switch is flipped.

While this system is switch or push button controlled, it also includes provisions for adding a radio or other type of remote control later without making basic changes. A design for remotely controlling this system will appear in this department later if readers indicate enough interest.

Let's get started on the motor drive unit.



You'll need a 1/8 or 1/4 hp motor, either a split-phase or capacitor start, with provisions for reversing directions. Home workshop tool motors are generally available in this size. Cover plates

MATERIALS LIST—MOTORIZED GARAGE DOOR

| No. | Description |
|-----|----------------------------------------------------------------------------------------------------------------|
| | Drive Unit |
| 1 | 1/8 or 1/4 hp, 110-V., 1725 rpm, single-phase, split-phase or capacitor-start motor. |
| 1 | 12 pitch, single thread worm, 1/2" bore (Boston Gear Works cat. #GH 1056) right hand |
| 1 | 12 pitch, single thread bronze worm gear, 30 teeth (Boston Gear Works cat. #GB 1051) |
| 1 | Allen shoulder screw, 1/2" dia x 2 1/2" shoulder length (length may vary depending upon the pulley hub width). |
| 1 | 2 1/2" dia, cast iron pulley, 1/2" V-belt, 5/8" bore (Sears or Wards) |
| 1 | flanged Oilite bushing, 5/8" O.D., 1/2" I.D., 1" long (Boston Gear Works cat. #FB-810-8) |
| 1 | U-shaped bracket, 1/8" mild-steel |
| 1 | large bicycle sprocket, 4" dia |
| 1 | 3" dia, cast iron pulley, 1/2" V-belt, 5/8" bore (Sears or Wards) |
| 1 | flanged Oilite bushing, 5/8" O.D., 1/2" bore, 1 3/4" long (Boston Gear Works cat. #FB-810-14) |
| 1 | Allen shoulder screw, 1/2" dia x 1 3/4" shoulder |
| 1 | steel sprocket (Boston Gear Works cat. #KSS 18) |
| 1 | flanged Oilite bushing, 5/8" O.D., 3/8" bore, 1 1/4" long (Boston Gear Works cat. #FB 610-10) |
| 1 | Allen shoulder screw, 3/8" dia x 1 1/2" shoulder |
| 2 | lengths 1/2" pitch single bicycle chain |
| 1 | 1/2" V-belt—length to suit mounting |

Boston Gear Works parts and Allen shoulder screws can be obtained by mail from Samuel Harris & Co., Dept. SM, 114-116 N. Clinton St., Chicago, Ill.

Electrical Components

| Key | Description |
|-----|---------------------------------------------------------------------------------------------------|
| S-1 | 2 Micro-Switch limit switches, normally closed, pin plunger, Type WZ-2R |
| | 2 Micro switch lever actuators, Type AD5721R |
| T-1 | 6.3v., 3-Amp. filament transformer (Thordarson) cat. #12-T-21F10 |
| K-1 | relay, 3 P.D.T., 110 v., a-c coil, Potter & Brumfield, cat. #90-MR 14A |
| K-2 | ratchet relay, D.P.D.T., 6-v. a-c coil, Potter & Brumfield, cat. #90-AP 11A |
| K-3 | 2 relays, S.P.S.T., normally open, 6-v. a-c coil, Potter & Brumfield, cat. #90-MR 1A |
| K-4 | 1 push type switch, momentary contact, normally off S.P.S.T. cat. #143-80630 |
| | 1 terminal strip, 10 terminal, Jones cat. #14-10-141 |
| | 1 terminal strip, 13 terminal, Jones cat. #14-13-141 |
| F-1 | 1 cartridge fuse cutout base, S.P., 250-v. barrier type |
| F-1 | 1 20-amp cartridge type fuse |
| | 1 surface type cabinet with hinged door, approx. 3 x 10 x 12" (any large electrical supply house) |

Electrical components with catalogue numbers may be obtained by mail from Cameradio Co., 1121-A Penn Ave., Pittsburgh 22, Pa.

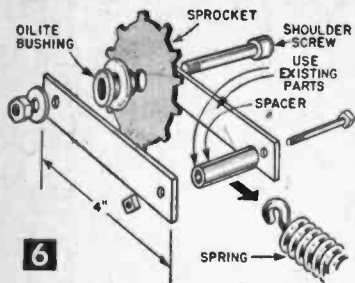

on the motor usually indicate directions for reversing rotation.

To reduce motor speed, a worm on the motor shaft drives a worm gear meshing with it at about 30-to-1 ratio (Fig. 5). See Materials List for source of worm reduction parts. Tap two holes in the hub for set screws to attach the worm to the motor shaft.

The worm gear is screwed to a 2½-in. dia cast iron, ½-in. V-belt pulley, ⅝-in. bore (Fig. 5). The V-belt pulley needs a bearing provided by pressing a 1-in. long Oilite flanged bushing, ⅝-in. O.D., into the pulley side of this pulley-gear assembly. A ½-in. dia x 2½-in. Allen shoulder screw forms a shaft for this assembly and is supported in a U-shaped steel bracket (Fig. 5). Mount the bracket on the motor cradle and position the worm on the motor shaft to properly mesh the worm and worm gear (Fig. 3).

To change the track mechanism, remove the following from one side of the door: the wire cable connecting the bottom door section to the door tension spring; the fixed pulley over which the wire rope formerly operated and the pulley mounting stud; and lastly the free pulley attached to the tension spring.

The bicycle sprocket (Fig. 4)

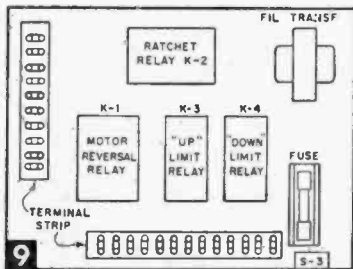

General arrangement of components in control box.

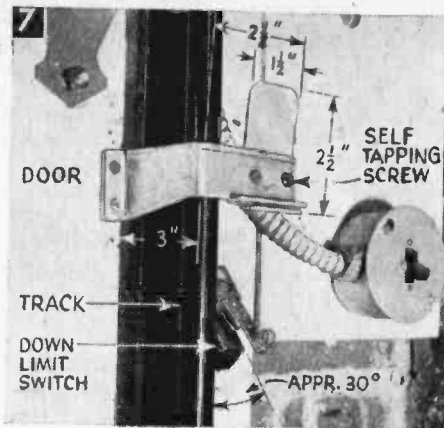

Down limit switch about to be tripped. Trip on door must clear track at all points of travel.

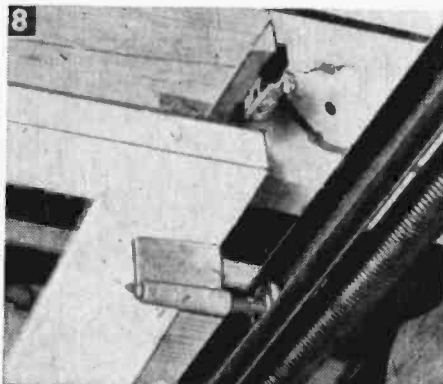

Up limit switch is actuated as door comes up.

should have a pitch diameter approximately equal to the fixed pulley formerly used. Screw this sprocket to a 3-in. dia, cast iron, ½-in. V-belt pulley with a ⅝ in. bore. Press the 1¾-in. long flanged Oilite bushing, into the pulley for a bearing surface (Fig. 6). Use another ½-in. dia x 1¾-in. shoulder Allen screw as a stationary shaft, so that the sprocket-pulley is free to rotate on it. Mount this assembly at the spot where the fixed pulley was located (Fig. 4).

The idler pulley is replaced with a ½-in. pitch single sprocket with a flanged Oilite bushing pressed into it (Fig. 3). A ⅝-in. dia Allen shoulder screw is used as a stationary shaft. Check

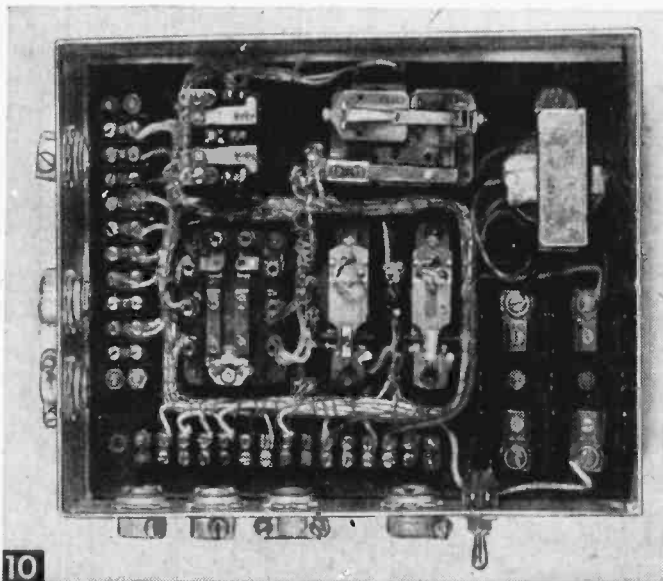

Interior of control box except that, here, two D.P.D.T. relays replace single 3-pole relay. Note how wiring runs in neatly tied cables.

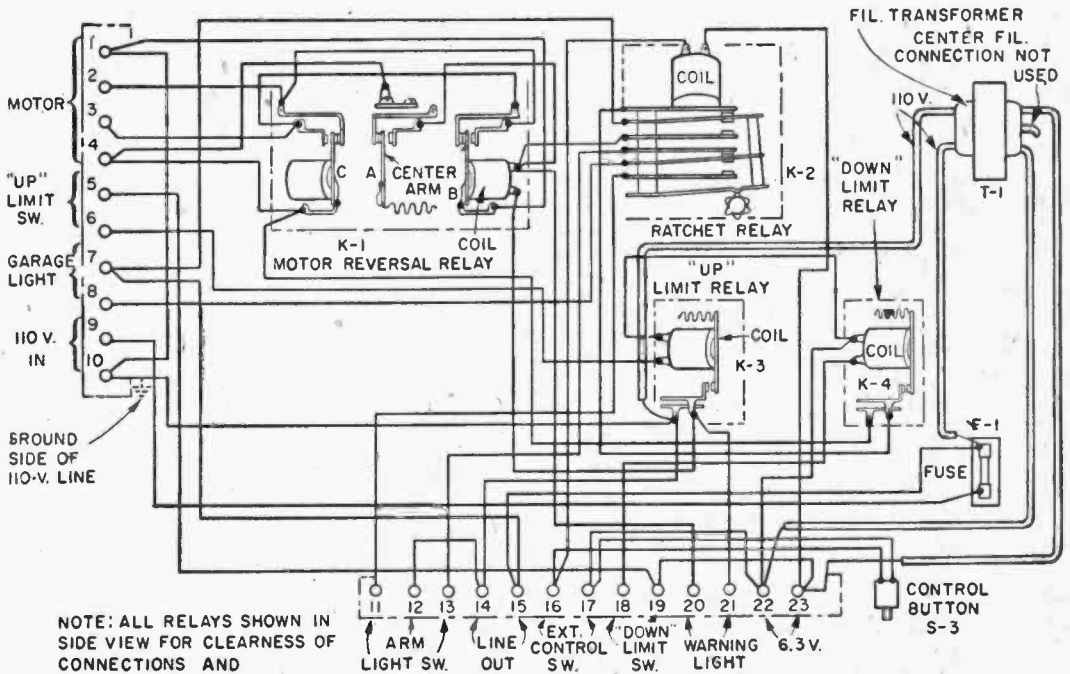
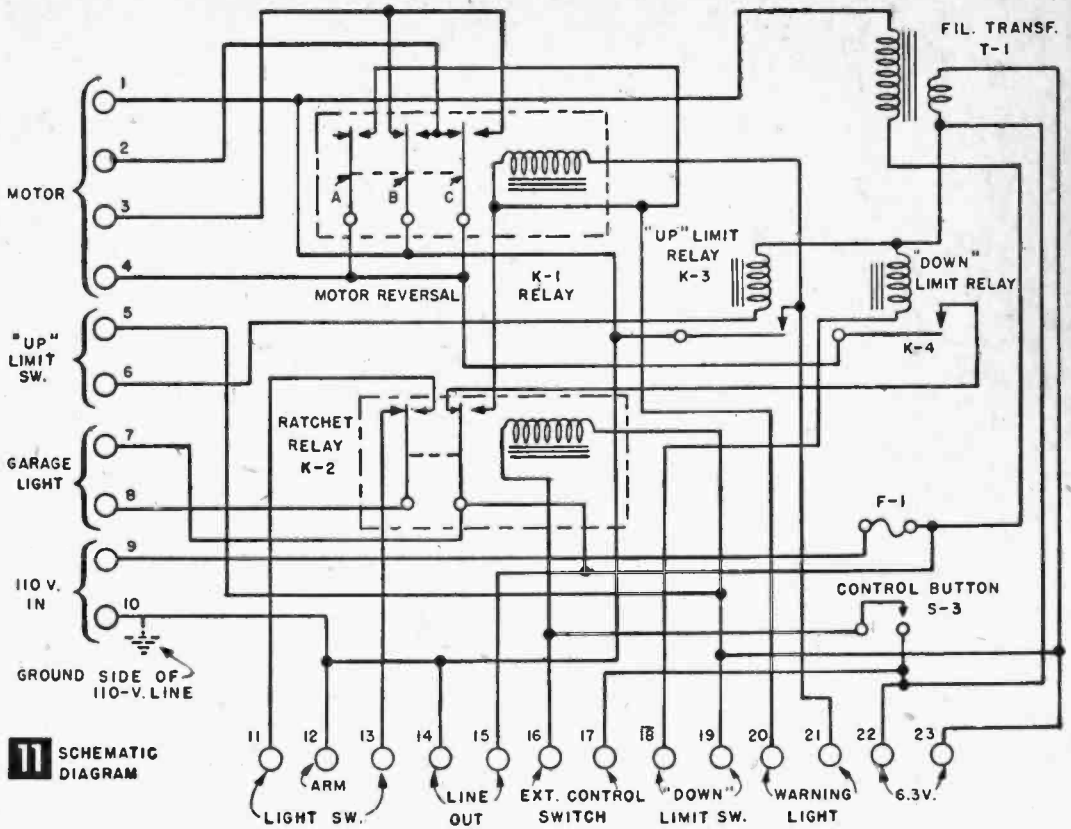

NOTE: ALL RELAYS SHOWN IN SIDE VIEW FOR CLEARNESS OF CONNECTIONS AND WITH POWER OFF

Chart A—Converting a Single Coil Spring Garage Door to Motor Operation

THE conversion of a single coil spring type of garage door to motorized operation is actually somewhat simpler than the conversion of the type of door described previously. This type of garage door (Crawford is one manufacturer) has a hollow shaft, about 1 in. in diameter, extending across the top of the door opening, on the inside of the garage. The shaft has two grooved drums, one on each end of the shaft (Fig. A). As the door is raised, the wire ropes extending from the bottom of the door, are automatically wound on each drum, and unwound as the door is lowered.

In some doors of this type, the shaft and drum assembly moves horizontally, from one to two inches, between the supporting bearings, as the door is raised or lowered; the winding and the unwinding of the wire rope produces this motion. A large single coil spring extends over most of the hollow shaft to assist in raising the door.

If the hollow shaft on your own garage door moves horizontally, then moving one drum toward the supporting bearing will provide space on the end of the shaft to mount the driven pulley. It will also eliminate this horizontal shaft motion, which would otherwise interfere with the motorized operation of the door. If the door shaft does not move horizontally, well and good, but the shaft must project about 1 in. beyond the drum, to allow the pulley to be mounted (Fig. A).

If the end of the shaft doesn't project enough to mount the pulley, you can disassemble the parts on one end of the hollow shaft, slip the pulley on the shaft, locating it between the end of the coil spring and the mounting bearing. But you will also need to dismantle again to get the driving belt on. You can, of course, add an additional 6-in. length of shafting, of a diameter that just slips inside the hollow shaft. Secure this added shaft by drilling a hole in the original shaft, so that the drum setscrew bears on

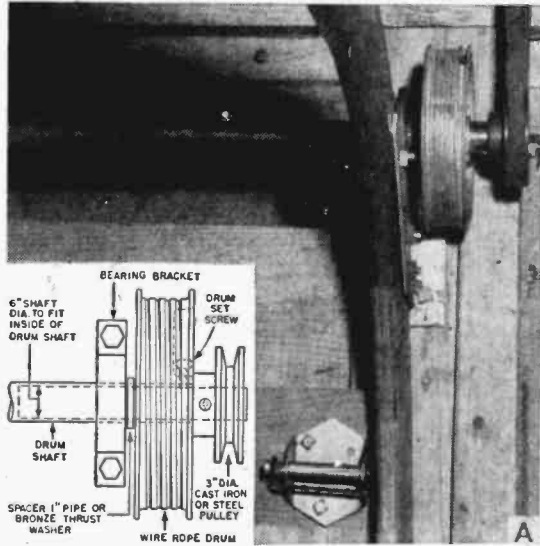

this added shaft, instead of the hollow shaft (Fig. A inset).

The 3-in. dia. driven pulley should be cast iron or steel (not die cast). It should be for a 1/2-in. V-belt, and provided with one or two socket-head set-screws. The bore of this pulley is determined by the O.D. of the hollow shaft, or of the diameter of the added shaft, if one is used. To get a good fit with the pulley, true up the hollow shaft with a file, in case it should have been distorted by the pressure of the drum set screw holding the drum in its original position.

Use a thrust-type porous bronze washer or well-lubricated 1/4-in. length of 1-in. pipe between each bearing and the drum to eliminate binding. For the bronze washers, try Samuel Harris & Co., Dept. SM, 114-116 N. Clinton St., Chicago, Ill.

Once you establish the location of the shaft pulley, mount the motor-reducer assembly so that its 2 1/2-in. pulley lines up with the pulley on the hollow shaft. Use a suitable length of a 1/2-in. V-belt to connect these two pulleys together.

The sprockets, their shoulder screws, Oilite bearings, and the bicycle chain are eliminated in this type of drive, thus simplifying the mechanical assembly considerably (compare Fig. 2 (see page 176) with Fig. 3). The electrical part of the control for this single coil spring-type garage door is the same as the one we described in the June '54 issue. However, you should locate the "up" limit switch so that the lower edge of the door, when in raised position, is two or three inches below the garage door opening. This provides a certain amount of gravity pull downward, when the motor drive starts the door on its downward travel.

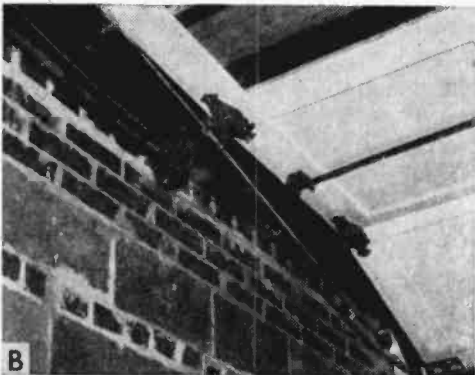

the existing idler pulley assembly for length of bushing and shoulder screw length required. Two used bicycle chains joined together replace the wire rope (Fig. 3). Each end of the chain is anchored at the same place where the wire rope was formerly attached. The bicycle chain provides a positive drive from the motor drive unit. The wire rope assembly on the other side of the door is left undisturbed. Make sure the sprockets match the link or pitch spacing of the chain.

Two limit switches control the stopping of the door, one at each end of its travel (Fig. 2). Auxiliary actuators fit over the limit switches for greater arm travel and to prevent damage to the switches.

Mount the bottom limit switch on the side of the door track, approximately 4 ft above the floor. A metal bracket (Fig. 7) fastened to the door trips the bottom limit switch when the door reaches 2 in. from its fully closed position and keeps it open on the door's downward travel (Fig. 7). The switch tripping bracket must extend outward far enough to clear the door track as the door moves along to open position.

The top limit switch is mounted horizontally on a bracket, with its lever arm pointing toward the back of the garage. The door itself trips this upper limit switch when the top edge of the door reaches a point 2 in. from the end of its travel to the fully open position (Fig. 8).

To assemble the parts and wire them for operation, first mount the motor drive unit so that the V-belt pulley lines up with the pulley of the pulley-sprocket assembly attached to the overhead track. Connect the two pulleys with a 1/2-in. V-belt. The belt allows for slippage when the door is closing and the motor is coasting with the power shut off (Fig. 4). In case of a motor malfunction you can manually operate the door by simply removing the belt.

direction of motor rotation each time that the control button is pressed; and two 6-volt ac S.P.S.T. relays connected in the limit switch circuits. A common filament transformer supplies the 6-volt limit switch control circuit which prevents any possibility of shock that might be present if the limit switches were operated on the usual 110 volts.

Fig. 9 shows the general arrangement of components in the relay control box. Fig. 11 is the schematic diagram of the wiring, while Fig. 12 shows a pictorial diagram of the same unit.

Use #18 or #16 stranded wire for wiring the control box. Use 1/2-in. plywood in box to mount the parts, then bolt plywood base inside cabinet. For 110-volt wiring to motor and switches inside garage (Fig. 13) use #14 BX cable. Use #14 lead or rubber covered wire to the switch on the post. The red warning light, located in the back of the garage, so as to be readily seen from the driver's seat, lights up until the garage door is raised to its fully open position.

Terminals 14, 15, 22, and 23 are not used as they have been provided for a future addition of remote control by radio. An S.P.S.T. switch in the 110-volt a-c supply circuit allows you to break the circuit at any time (S-5, Fig. 13).

As only one fuse is used in the control box, make sure that it is connected in the live or ungrounded side of the line terminal. Terminal #9 should be connected to this same live side of the line. To determine which side of the line is live, connect a 110-volt lamp from each wire to ground. The line which causes the bulb to light is the live line.

If necessary to correct rotation of the motor, reverse the motor leads connected to terminals 3 and 4 of the relay control box. As a check, the downward motion of the door should stop if the Down limit switch lever is pressed by hand and resume when it is released.

Caution: Make sure the motor completes the cycle of driving the door in one direction before pressing the control button on the relay control box or on the outside post to reverse the motion to prevent upsetting sequence of operation. Should you accidentally press one of the control buttons before the door has completed its travel, press the button again to keep the ratchet relay in step with motor rotation.

Apply a little water pump or other similar grease to the worm and worm gear, sprockets, and sprocket chain occasionally. It is advisable to cement a strip of sponge rubber, such as used on car doors, to the bottom edge of the garage door, so the door is able to coast to a rest on rubber.

A phone plug, with its two terminals shorted across, acts as the switch and is carried in the car for this purpose. One has only to plug it into the jack when the car pulls alongside the posts in the driveway to operate the door. It provides simple means to prevent tampering by unauthorized persons.

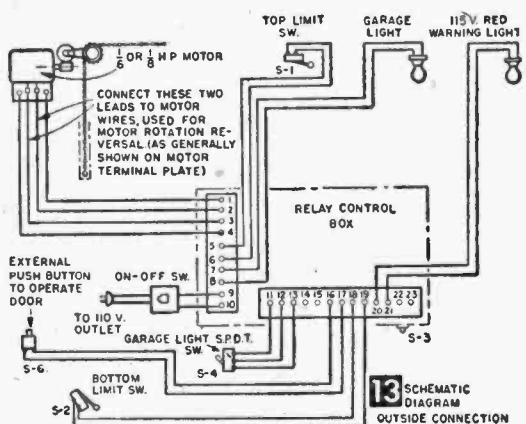

The automatic control circuit for the motor is housed in the control relay box. It consists of a 3 P.D.T. relay for reversing the motor rotation; a ratchet relay which automatically reverses the

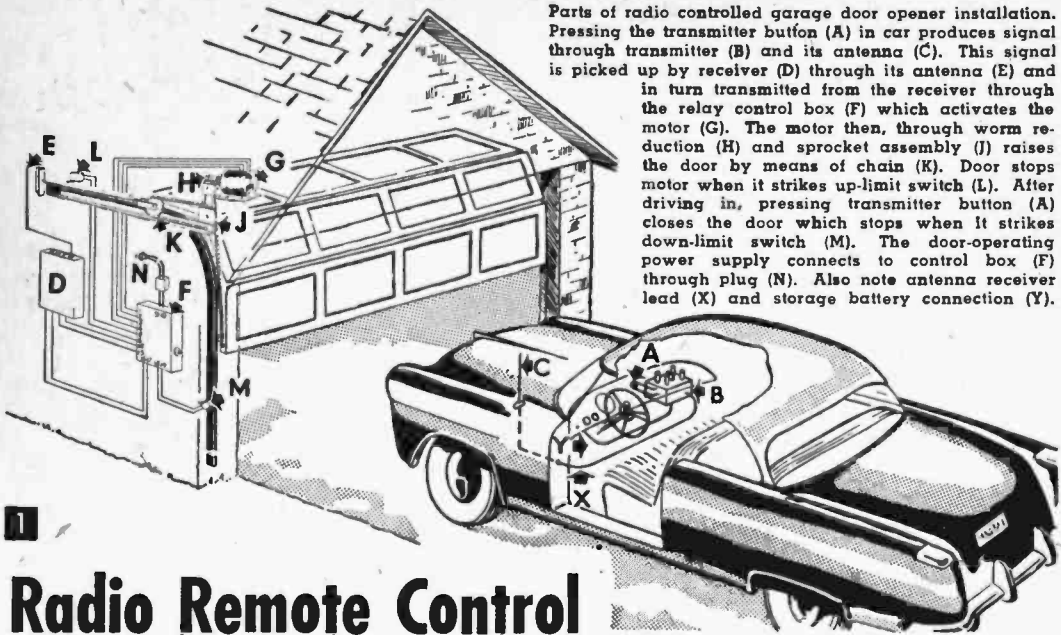

Parts of radio controlled garage door opener installation. Pressing the transmitter button (A) in car produces signal through transmitter (B) and its antenna (C). This signal is picked up by receiver (D) through its antenna (E) and in turn transmitted from the receiver through the relay control box (F) which activates the motor (G). The motor then, through worm reduction (H) and sprocket assembly (J) raises the door by means of chain (K). Door stops motor when it strikes up-limit switch (L). After driving in, pressing transmitter button (A) closes the door which stops when it strikes down-limit switch (M). The door-operating power supply connects to control box (F) through plug (N). Also note antenna receiver lead (X) and storage battery connection (Y).

Radio Remote Control For Your Garage Door

By N. RASKHODOFF

PRESS a button inside the warm comfort of your car, and, presto, the garage door opens, even though your car is still 50 to 100 feet away from the garage (Fig. 1). As the door opens, the garage light goes on, and after driving in, pressing the same button closes the garage door.

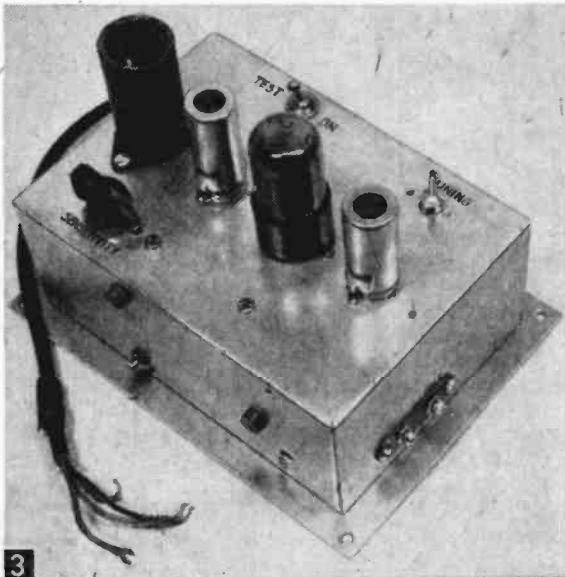

Top view of receiver, showing components in place in aluminum chassis, and backing plate also in place.

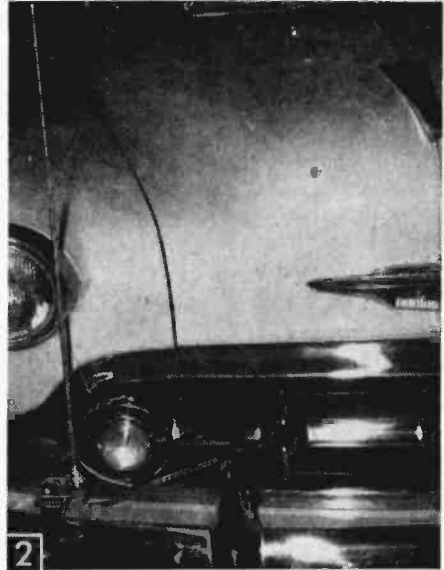

Front end mounting of transmitter's whip antenna.

What will such a luxury cost you to operate? About 75¢ a month. And you can figure it will increase the value of your property several times what the installation will cost you.

How to motorize a garage door so it can be opened electrically by a pushbutton mounted on a post has been previously described.

Those who have a single coil spring type door (such as the Crawford) also will need the special instructions contained in Chart A.

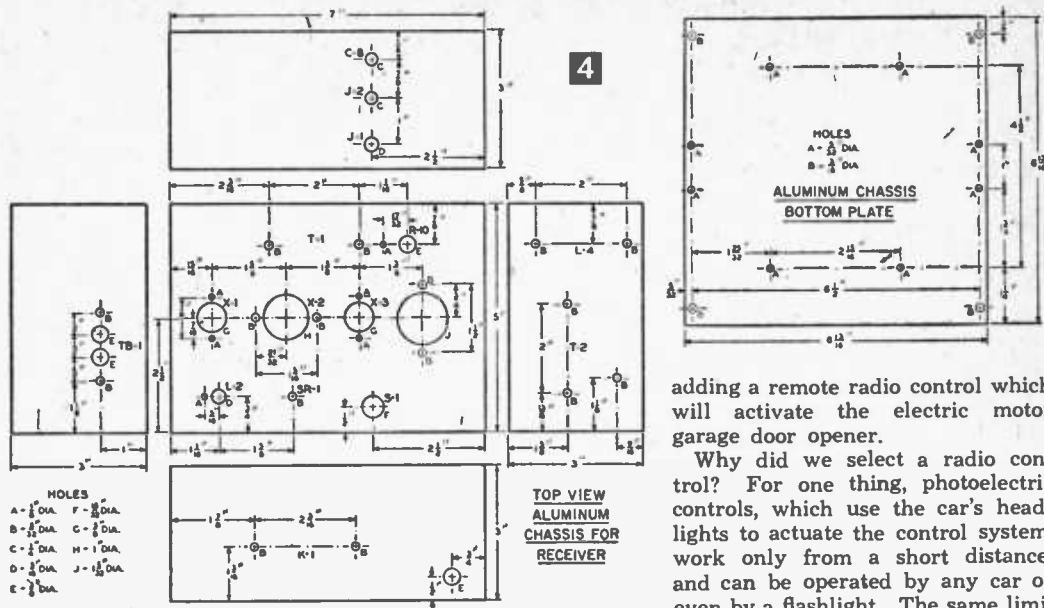

Now, let's say you want to add to your plans for motorizing the door the further luxury of not even having to roll down the car window to operate the button. Here is the story on

adding a remote radio control which will activate the electric motor garage door opener.

Why did we select a radio control? For one thing, photoelectric controls, which use the car's headlights to actuate the control system, work only from a short distance, and can be operated by any car or even by a flashlight. The same limitations

apply to sound type controls operated by the car's horn, not to mention the additional problem of producing objectionable noise in the early morning hours.

MATERIALS LIST—RECEIVER

| | | | | | | | |
|------|--------------------------------------------------------------------------------------|----------------------------------------------------------------------------|----------------------------------------------------------------------------------------------------|-------------------------------------------------------------------------------------------------------------------------------------------------------------------------------------------------------------------------------|----------------------------------------------------------------------|--------------------------------------------------------------|--|
| C-1 | 10 mmfd Erie Ceramicon, ± 10%, zero temperature coefficient (#34-NP0K-100) | R-14 | 4700 ohm 1/2 watt Ohmite composition resistor, ± 10% (#55-1/2W-10%-4700) | | | | |
| C-2 | 51 mmfd Cornell-Dubilier mica capacitor, ± 5% (#3-22R-5Q51) | T-1 | 1-3 Interstage input transformer, 1 plate to 1 grid, Stancor #A-53 (Cameradio #32-A-53C) | | | | |
| C-3 | 100 mmfd Erie Ceramicon capacitor, ± 20%, general purpose (#34-GPIK-101) | T-2 | Power transformer, Sec. 125v. 15 MA, 1/2 wave, Heater 6.3v, .6 amp, Stancor #PS-8415 (#32-PS-8415) | | | | |
| C-4 | | K-1 | 10,000 ohm plate relay S.P.D.T., type LS-5 Potter & Brumfield (#90-LS-5-10,000) | | | | |
| C-5 | | S-1 | 3 position D.P.D.T. toggle switch, center "off," Arrow-Hart & Hegeman #82024 (#143-82024) | | | | |
| C-6 | .005 mfd Erie HI-K Disc Ceramicon (#34-811.005) | SR-1 | 65 MA 130v selenium rectifier, Federal Miniature type, 1" square (#170-1002A) | | | | |
| C-7 | 1000 mmfd CRL Ceramic type RC HI-Cap capacitor (#165-D6-102) | X-1 | 17 Pin miniature statelite socket, top mount, Amphenol 147-921 (#1-147-921) | | | | |
| C-8 | 650-1900 mmfd Elmenco type 30 mica variable padder (#310 Elmenco) | X-3 | Octal, grounded lug (Saddle) type socket, Amphenol #74-8T (#1-74-8T) | | | | |
| C-9 | 20-20 mfd 150v dual capacitor, selenium rectifier type, Cornell-Dubilier (#3-X8001) | X-2 | 2 6AK6 tubes (#6AK6) | | | | |
| C-10 | | 12 mfd 150v Cornell-Dubilier electrolytic capacitor (#3-BR-1215) | 1 | 6SL7 tube (#6SL7) | | | |
| C-11 | 470 mmfd Erie Disc Ceramicon capacitor (#34-811.471) | TB-1 | Terminal strip, 2 terminal, Bakelite insulation, Jones (#14-2-50) | | | | |
| C-12 | .5 mfd 400v Cornell-Dubilier tubular capacitor (#3-CUB4P5) | TS-1 | Tie point strip, 1 insulated lug, 1 foot, no ground lug (#116-5101) | | | | |
| C-13 | .05 mfd 200v Cornell-Dubilier metallized capacitor (#3-MP-255) | TS-2 | | | | | |
| C-14 | .25 mfd 200v Cornell-Dubilier metallized capacitor (#3-MP-2P25) | TS-3 | | Tie point strip, 2 insulated lugs, 1 foot, no ground lug (#116-5201) | | | |
| L-1 | (See text) | TS-4 | Tie point strip, 4 insulated lugs, 1 foot, no ground lug (#Cinch 54-B) | | | | |
| L-2 | 27.255 MC slug-tuned Miller coil (Ace Radio Control) | J-1 | Phono tip jack, insulated, black Am. Radio Hardware (#116-138) | | | | |
| L-3 | RFC coil (Ace Radio Control) | J-2 | | 7 pin miniature tube shields (cad.-plated steel), 1 3/4" long, Amphenol #5-402 (#1-5-402) | | | |
| L-4 | 4 1/2 Henry filter choke coil, 50 MA, 300 ohm Stancor #C-1706 (Cameradio #32-C-1706) | 1 | Aluminum chassis 5" wide, 7" long, 3" deep, ICA (#ICA-29047) | | | | |
| R-1 | 220 ohm 1/2 watt Ohmite composition resistor, ± 10% (#55-1/2W-10%-220) | 1 | Bottom plate, chassis, aluminum, 7" by 7", ICA (#ICA 8723) | | | | |
| R-2 | 390K, 1/2 watt Ohmite composition resistor, ± 10% (#55-1/2W-10%-390K) | 1 | Bar knob, 1/4" dia, 5/8" high, ICA (#18-1274) | | | | |
| R-3 | | 6.8 meg 1/2 watt Ohmite composition resistor, ± 10% (#55-1/2W-10%-6.8 meg) | 1 | Rubber covered cord, 4 #20 conductors, Belden Shielded, length to suit (#2-8424); miscellaneous hardware, screws, lock washers, nuts, lock washer-type soldering lugs, rubber grommet, cable clip, interconnecting wire, etc. | | | |
| R-4 | | | 4.7 meg 1/2 watt Ohmite composition resistor, ± 10% (#55-1/2W-10%-4.7 meg) | | | | |
| R-5 | | | | 25,000 ohm, type AB, 2 watt Ohmite potentiometer, type CU-2531 with shaft 2" long (#55-CU-2531) | | | |
| R-6 | | | | | 47 ohm 1/2 watt Ohmite composition resistor, ± 10% (#55-1/2W-10%-47) | | |
| R-7 | | | | | | 820 ohm 1 watt IRC wire-wound resistor, ± 5% (#5-BW1-820-5%) | |
| R-8 | 22K 2 watt Ohmite composition resistor, ± 10% (#55-2W-10%-22K) | | | | | | |
| R-9 | | | | | | | |
| R-10 | | | | | | | |
| R-11 | | | | | | | |
| R-12 | | | | | | | |
| R-13 | | | | | | | |

Sources: Stock numbers given in parenthesis are catalog numbers for parts obtainable from Cameradio Co., 1121-SM Penn Ave., Pittsburgh 22, Pa. The Ace Radio Control parts may be obtained by writing to Ace Radio Control, Dept. A, Box 301, Higginsville, Mo. This company also will supply a complete kit of parts for this receiver, including an already drilled chassis, hardware, wiring material and assembly instructions.

Then there is the induction-type remote control, which has a large coil buried in the driveway, and a similar coil in the car actuating the control system. This also operates only over a short distance, and who wants to tear up his driveway to install such a system?

So we chose a radio control system as the most promising. And we avoided the carrier type of radio control, where a radio transmitter in the car actuates a radio receiver in the garage. With such carrier type systems there is a good chance that other extraneous radio impulses might trigger off the receiver.

On the other hand, with the modulated type of radio control, the transmitter signal in the car is modulated at an audio frequency of 500-1500 cycles, and the receiver in the garage (controlling the door opening mechanism) responds only to this type of signal. This is the system

we will describe in this article. It extends the reliable operating range of the garage control to from 75-100 feet. Thus, before the car reaches the front of the garage, the garage door is already open, or on leaving, you can close the door after you have left the driveway. You could even extend this range much further, but unless you can easily see the garage door from the car, you may close the door on a child, or an object placed near the garage door opening.

Since this system involves a transmitter, it also involves FCC (Federal Communications Commission) regulations. But the FCC has now opened two "Citizens' Band" sets of frequencies at low power transmitter operation, at 27,255 megacycles and 465 megacycles. Due to the strict restrictions on transmitter construction, and the difficulties in having the equipment operate on the 465 megacycle band, the 27,255 megacycle band has become the more popular, especially for model airplane work.

To operate our car transmitter, whose input power is limited by the FCC to a total of 5 watts to the plate of the oscillator tube, you don't have to obtain an amateur license or pass a test. But you will have to apply for and fill out Application Form #505 at the nearest FCC office. For a list of FCC regional offices, write for Bulletin 455R, SCIENCE AND MECHANICS, 450 East Ohio St., Chicago 11, Ill., enclosing 10¢ to cover mailing costs.

The transmitter design shown here meets three other important FCC rules: (1) it is crystal controlled, (2) its frequency variation is limited to .04% or 109 kilocycles, and (3) the radiation of the harmonic frequencies is kept down to a very low minimum. The transmitter also incorporates its own power supply, uses filament type tubes for almost instant operation, and a simple pushbutton control.

You will have the choice of using the receiver as is, that is, in a form which operates

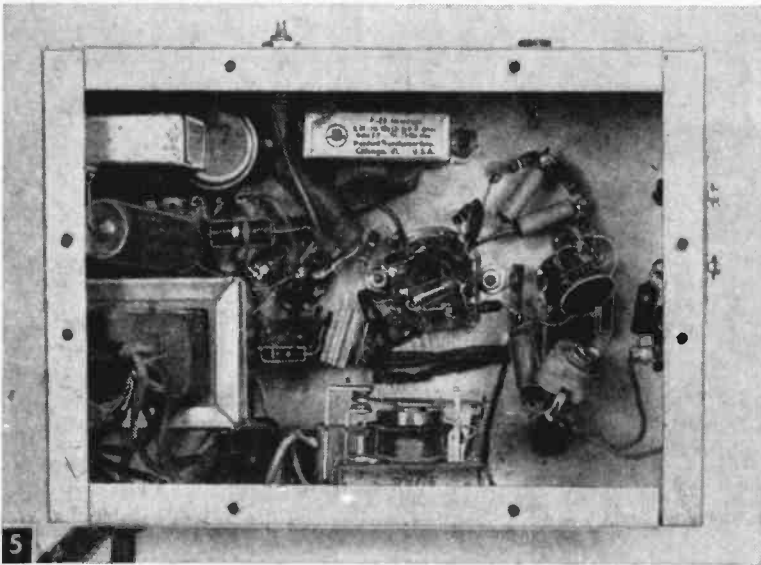

Underneath view of receiver with components in place. Note how component locations are inked on chassis to permit easy adjustment and replacement.

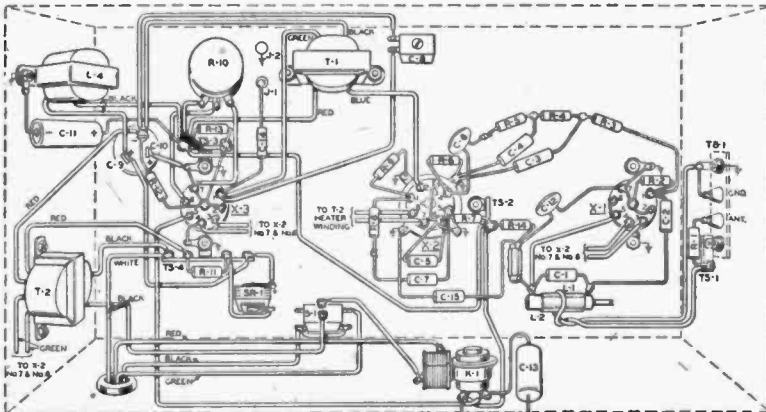

6 BOTTOM VIEW OF RECEIVER CHASSIS

tery systems.

The transmitter uses a 3A4 miniature tube as a crystal-controlled oscillator, operating at 27.255 mc in the Citizens' Band. An NE-2 neon tube oscillator drives a 3V4 modulator tube, which in turn applies a tone of about 1,000 cycles to the screen of the 3A4 oscillator tube. A single turn loop (actually a "U"-shaped form) coupled to the tank coil, with a #48, 2 volt, .060-amp. pilot bulb soldered to its ends (A in Fig. 8) is used for tuning the transmitter to the crystal frequency. The tank coil tuning slug is varied to obtain the brightest bulb illumination.

Drill the mounting holes in the chassis as shown in Fig. 9, and then begin mounting and wiring as in Figs. 10 through 12. For the 12-volt operation, note alternate mounting hole dimension in Fig. 9 and detail of mounting method in Fig. 10A.

The transmitter power supply consists of a vibrator transformer, to which is connected a Mallory interrupter. Two 65 ma selenium rectifiers are used, and the center tap of the power transformer's secondary returns to ground through a 56-ohm protective resistor. A 4½ henry choke is used to obtain a relatively clean d-c supply. A fuse in the battery supply circuit protects against accidental shorts.

Mount the electrolytic capacitor on the metal wafer mounting plate furnished with it, by twisting mounting lugs with pliers.

The NE-2 neon bulb is supported in the ¼-in. I.D. rubber grommet, which is in turn supported from a piece of #14 enameled copper wire, soldered to the ground connection on the antenna terminal jack (Figs. 10 and 11).

Connect the antenna to the transmitter with a phono jack and plug assembly. Above the jack, mount the tuning light for the 3A4 (Fig. 8), supporting the pilot bulb in a ¾-in. I.D. rubber grommet, so the coupling of the tuning loop can be varied by rotating the bulb. Mount the slug-tuned tank coil as you did its counterpart in the receiver.

Note that the parts are arranged so you can replace tubes, vibrator, and crystal from the top of the chassis (Fig. 8). Keep all connections short, since the transmitter parts are assembled

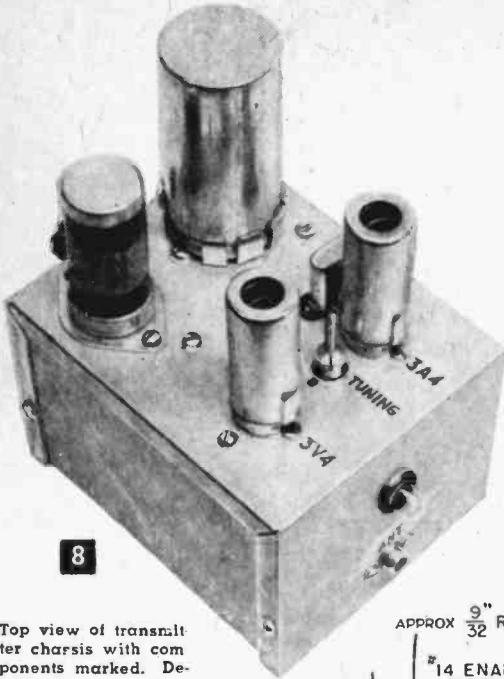

8
Top view of transmitter chassis with components marked. Detail shows L-1 coil or "U"-shaped form which is used when tuning transmitter to correct crystal frequency.

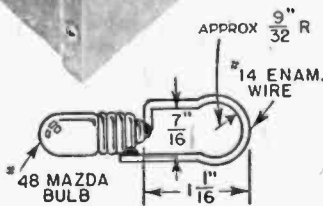

The transmitter is assembled on a 4 x 5 x 3-in. Bud Mini-Box, used as a chassis because it separates into two parts for easier assembly and wiring. Note that the transmitter is designed for use either on a 6-volt or 12-volt battery supply. Before ordering transmitter parts, check the voltage of your car battery. The transmitter materials list has been made for 6-volt battery operation and the 12-volt items have been added at the end, and those which they replace in the 6-volt system are marked with a double asterisk (**). They are the filament dropping resistors, the vibrator transformer, and the vibrator. Many new 1955 cars have 12-volt bat-

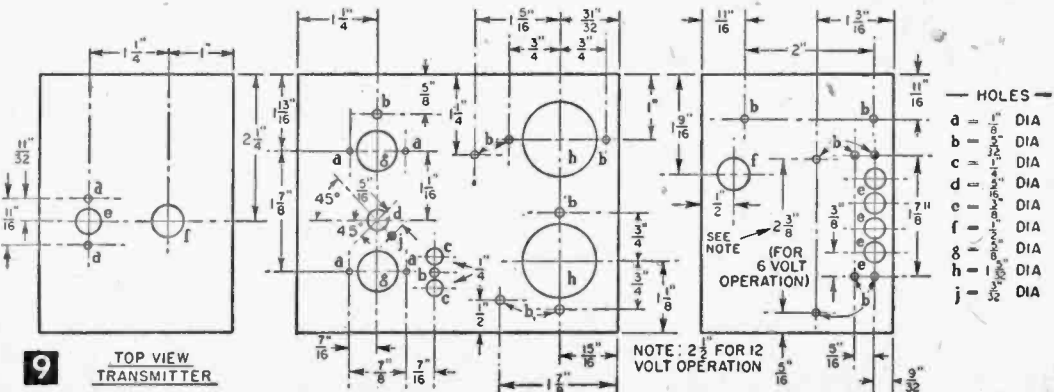

9
TOP VIEW TRANSMITTER

in a very limited space. Leave the mounting and wiring of the vibrator transformer and the choke until after you have wired and checked all the other components.

You can make the bracket shown in Fig. 13, for mounting the transmitter inside the firewall, upward and away from either the car pedals or driver's feet. We mounted the transmitter on the left side (the right side is usually blocked by the car heater), with the transmitter mounting bracket located about 9 in. above the brake pedal, and to the right of the steering post (Fig. 14).

Leaving off the antenna connection to the transmitter, it can first be bench tested by shorting terminals #1 and #2 on the terminal board TB-1, and connecting a 6 or 12-volt storage battery to the two on the right, or to numbers 3 and 4 (Fig. 11). Plug the crystal in, and then adjust the slug-tuning screw (marked "tuning") on top of the chassis until the pilot light glows (indicating resonance) up to the maximum brilliance. To get a good indication, you may need to adjust the plane of the coupling loop, by turning the bulb slowly in the rubber grommet. After obtaining maximum brilliance, change the slug adjustment slightly to one side of this maximum brilliance position, to obtain oscillator stability. You will find two adjustments possible, one from each side of the maximum brilliance. Select the side which has the broader or longer slug adjustment. The final oscillator adjustment should be made with the transmitter resting on the floor of the car and the antenna connected to it.

When bench checking the transmitter, you can measure the plate current to the 3A4 oscillator tube by temporarily disconnecting the low end of the RF choke from the +B and inserting a 0.25 ma milliammeter in series. With an input voltage of 6 volts, the +B voltage should be about 155 volts, and the plate current, with the pilot light glowing, should be about 10½ ma. Thus, the approximate power input to the plate

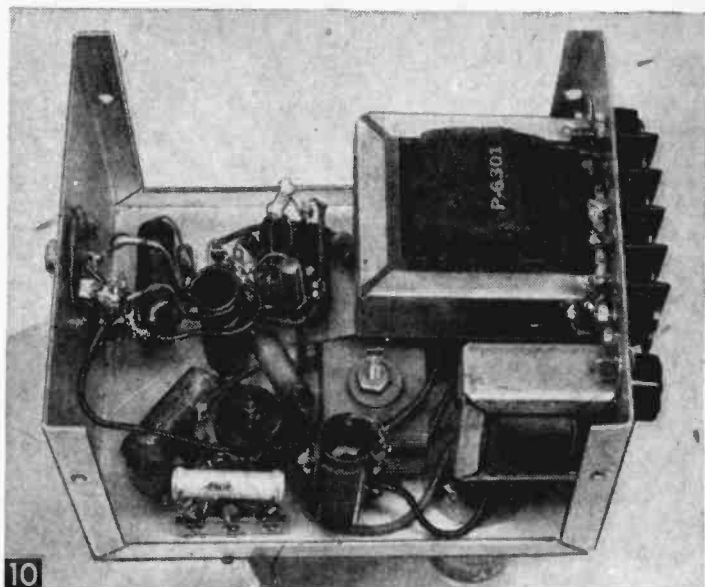

Underneath transmitter, showing components in place.

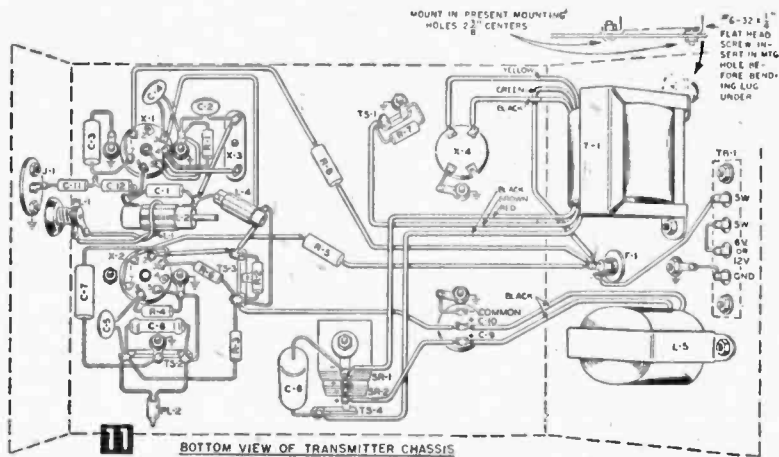

of the 3A4 tube is 1.6 watts, and the FCC allows a 5 watt maximum.

Also check the transmitter oscillating frequency by tuning it to a communications receiver set to 27.25 mc. Once you check the transmitter frequency, you can then use the transmitter as a signal generator for setting the receiver frequency control.

To install the transmitter in the car, secure the mounting bracket (Fig. 13) to the car's firewall with two ¾-in. dia. by 1½ in. long self-tapping screws. Mount the control button (Fig. 15 and materials list) on the instrument panel lip with a small bracket (Fig. 16A). When pressed, this button connects car's storage battery to the transmitter, and you may want to mount it to the left of the steering post—out of reach of small children in the front seat. Connect this button to terminals #1 and #2 on the terminal block on the transmitter; the #3 ter-

MATERIALS LIST—TRANSMITTER

For 6-volt Operation:

| | |
|------|-------------------------------------------------------------------------------------------------------------------------------------------------------------------------------------------------------------------|
| C-1 | 10 mmdf Erie Ceramicon capacitor, $\pm 10\%$, zero temperature coefficient (#34-NPOK-100) |
| C-2 | 470 mmdf Erie HI-K disc capacitor (#34-811.471) |
| C-3 | .05 mfd 400v Cornell-Dubilier paper capacitor (#3-PJ-455) |
| C-4 | .005 mfd Erie HI-K disc capacitor (#34-811.005) |
| C-5 | |
| C-6 | 1,000 mmdf Erie Ceramicon capacitor, $\pm 20\%$, general purpose type (#34-GP2L-102) |
| C-7 | .1 mfd 400v Cornell-Dubilier metallized paper capacitor (#3-MP-4P1) |
| C-8 | .008 mfd 1600v Cornell-Dubilier paper buffer capacitor (#3-CUB-16D8) |
| C-9 | 20-20 mfd 250v Mallory type FP electrolytic capacitor, metal mounting wafer (#47-FP-217) |
| C-10 | |
| C-11 | 1.5 mmdf Erie Ceramicon capacitor, $\pm 10\%$, zero temperature coefficient (#34-NPOK-1R5) |
| C-12 | |
| L-1 | Single turn loop (see text and Fig. 8) |
| L-2 | Coil with 17 turns of #20 enameled wire, wound on a $\frac{3}{8}$ " dia. phenolic form, with a $\frac{3}{16}$ " dia. tuning slug for tuning, or buy wound 27.255 MC slug-tuned Miller coil from Ace Radio Control |
| L-4 | RFC coil (One layer of #34 enameled wire wound on a $\frac{1}{4}$ " dia. phenolic form for a distance of $\frac{3}{4}$ "), or buy from Ace Radio Control |
| L-5 | $4\frac{1}{2}$ Henry filter choke coil, 50 MA 300 ohms, Stancor #C-1706 (#32-C-1706) |
| R-1 | 100K $\frac{1}{2}$ watt Ohmite composition resistor, $\pm 10\%$ (#55- $\frac{1}{2}$ W-10%-100K) |
| R-2 | 10K $\frac{1}{2}$ watt Ohmite composition resistor, $\pm 10\%$ (#55- $\frac{1}{2}$ W-10%-10K) |
| R-6 | 6.2 meg $\frac{1}{2}$ watt Ohmite composition resistor, $\pm 10\%$ (#55- $\frac{1}{2}$ W-10%-6.2 meg) |
| R-3 | |
| R-4 | 5.6 meg $\frac{1}{2}$ watt Ohmite composition resistor, $\pm 10\%$ (#55- $\frac{1}{2}$ W-10%-5.6 meg) |
| *R-5 | 43 ohm 1 watt IRC wire-wound resistor, $\pm 5\%$ (#5-BW1-5%-43) |
| R-7 | 56 ohm $\frac{1}{2}$ watt Ohmite composition resistor, $\pm 10\%$ (#55- $\frac{1}{2}$ W-10%-56) |
| *R-8 | 22 ohm 1 watt IRC wire-wound resistor, $\pm 5\%$ (#5-BW1-5%-22) |
| *T-1 | Vibrator transformer, 150v, D.C., 40 MA, Stancor #P-6301 (#32-P-6301) |
| F-1 | Type 3AG fuse, 8 amp Littelfuse (#42-312008) |
| SR-1 | Selenium rectifier, 65 MA 130v, Federal Miniature |
| SR-2 | 1002A (#170-1002A) |
| X-1 | 7 pin miniature steatite socket, Amphenol 147-921 (#1-147-921) |
| X-2 | |
| X-3 | Crystal socket, $\frac{1}{2}$ " spacing, .050" pins, steatite, Millen (Millen #33302) |
| X-4 | 4 pin MIP socket, mica filled, Amphenol #77-MIP-4T (#1-77-MIP4T) |
| 1 | 3A4 tube (#3A4) |
| 1 | 3V4 tube (#3V4) |

| | |
|-------|------------------------------------------------------------------------------------------------------------------------|
| CR-1 | Crystal, 27.255 MC, $\pm .04\%$, .050" pins, $\frac{1}{2}$ " spacing type Z-9, Petersen Radio Co. (Ace Radio Control) |
| *VR-1 | Mallory vibrator, interrupter type 4-4 (#47-4-4) |
| PL-1 | Dial light, Mazda #48 miniature screw base, 2v .060 amp (#153-48) |
| PL-2 | Neon lamp, $\frac{1}{5}$ watt type NE-2 (#153-NE-2) |
| J-1 | Phono Jack, Cinch #81A (#147-81A) |
| TB-1 | Terminal strip (4 terminals), type 140Y, H.B. Jones (#14-4-140Y) |
| TS-1 | Tie point strip, 1 insulated lug, 1 ground lug foot (#116-5110) |
| TS-2 | Tie point strips, 2 insulated lugs, 1 foot, 1 ground lug (#116-5210) |
| TS-3 | |
| TS-4 | 2 |
| 2 | 7 pin miniature tube shields (Cad.-plated steel), 1 $\frac{3}{4}$ " long, Amphenol 5-402 (#1-5-402) |
| 1 | Fuse extractor post type 3AG Littelfuse 342003 (#42-342003) |
| 1 | Vibrator grounding cup, $\frac{1}{2}$ " dia. Mallory (#47-GC7) |
| 1 | Mini-Box, 5" long, 4" wide, 3" deep, Bud #CU-3005 (#6-CU-3005) |

For 12-Volt Operation:

Substitute the following items in place of the items marked ** in the 6-volt materials list above, if your car has a 12-volt battery.

| | |
|------|--------------------------------------------------------------------------------------------------------------------------------------|
| R-5 | 100 ohm 2 watt IRC wire-wound resistor, $\pm 5\%$ (#5-BW2-5%-100) |
| R-8 | 51 ohm 2 watt IRC wire-wound resistor, $\pm 5\%$ (#5-BW2-5%-51) |
| T-1 | 12-volt vibrator transformer, 150v D.C. 40 MA, Hall-dorson V3900, Hall-dorson Transformer Co., 2734 N. Pulaski Rd., Chicago 39, Ill. |
| VR-1 | Mallory vibrator, interrupter type #G874 (47-G874) |

MISCELLANEOUS MATERIALS—GARAGE OPENING RADIO UNIT

Miscellaneous hardware, screws, lock washers, nuts, lock washer-type soldering lugs, rubber grommets, connecting wire, insulating sleeving, etc.

| | |
|------|-----------------------------------------------------------------------------------------------------------|
| 1 | Momentary contact, push button switch, 2 circuit, 1 amp, 125v Arrow-Hart & Hegeman Type 3392 (#AH&H 3392) |
| 1 | Red button for above switch (#AH&H 3391-194R) |
| 6 | Television antenna insulators, #10-32 machine screw type, Amphenol (#Amphenol 66-204) |
| 8 ft | Television flat antenna lead |
| 1 | Phono plug, Cinch #13A (#147-13A) |

Parts with catalog numbers in parenthesis may be obtained from Cameradio Co., 1121-SM Penn Ave., Pittsburgh 22, Pa. Parts listed for Ace Radio Control are obtainable from Ace Radio Control, Box 301, Higginsville, Mo. In addition, Ace Radio Control will supply the complete kit of transmitter parts including hardware, wiring, an already drilled chassis, and complete instructions to simplify building.

minal is connected to the ungrounded side of the car's battery (Fig. 15). This connection from the #3 terminal is made either to the dead side of the ignition switch, or at a junction box with which some cars are equipped. If connecting at the junction box, use the terminal on the junction box which is connected through the ignition lock, so that the transmitter won't operate unless the ignition switch is on.

Make the connecting wires to the transmitter long enough so the transmitter can be test-operated on the floor of the car, before it is fastened to the firewall. It is held on the mounting bracket with four #6 self-tapping screws. Incidentally, when operating the transmitter off the mounting bracket, temporarily run a ground wire to the transmitter terminal #4.

Antenna System. We found the easiest and neatest antenna installation is one which uses an 8-ft. length of flat television lead-in wire, mounted within the hood of the car (Fig. 17). To keep the wire in place, and the capacity to ground low, support the lead-in wire with several TV antenna lead-in insulators, which have 10-32 threaded ends. Figure 16B shows how the TV

insulators are supported on small brackets made out of $\frac{1}{16}$ -in. aluminum bent to convenient shape, and caught under existing screws or bolts within the engine compartment. Support the free end of this wire across the front of the car, in the space between the radiator and the grill.

When passing the lead-in wire through the firewall and other partitions, keep it clear of metal as far as possible. Connecting the antenna lead to the transmitter should not detune it enough to put out the tuning light; if it does, that indicates there is excessive antenna capacity, and you then check the entire length of antenna lead to make sure it is not too close to car or actually shorted or grounded somewhere.

If you want to increase the effective range of the transmitter considerably and allow the receiver sensitivity control to be cut back, you can mount a whip-type antenna on the front bumper (Fig. 2), connecting the free end of the TV lead-in to this whip. The whip is extended to a length of three feet or so, to get this increased range. Cut off the shielded lead-in wire (normally furnished with this type of antenna)

close to the whip, and connect the TV lead-in wire to the whip.

An auto radio receiver antenna, mounted on the fender of the car, also makes a suitable transmitter antenna (Fig. 1) but the shielded lead-in that normally comes with it, should be replaced with the TV lead-in as above.

System Installation.

The receiver is installed in the garage, directly below the relay control box of the motorized garage door (Figs. 1 and 18). Figure 19 shows the four connections required from the receiver to the relay control box. A ground connection should be made to the receiver and also to the relay control box. Use shielded lead-in wire from the receiver antenna to the antenna terminal on the receiver; this is especially important if the lead-in has to be run near the house wiring.

Testing the System. Note the two positions on the receiver control switch marked "on" and "test," with the "off" position being in the center. Set the switch to the "test" position, plug a pair of headphones into the phone jacks, and let the receiver warm up for 10 minutes. Park your car in the driveway a short distance away, and temporarily short out the transmitter control button, so that you only have to turn on the ignition key to operate the transmitter. Then connect the antenna to the transmitter, and connect a short length of wire to the receiver as an antenna. You should hear the familiar hiss of the super-regenerative receiver in the headphones. Turn the transmitter on and listen in the headphones, rotating the slug adjusting screw marked "tun-

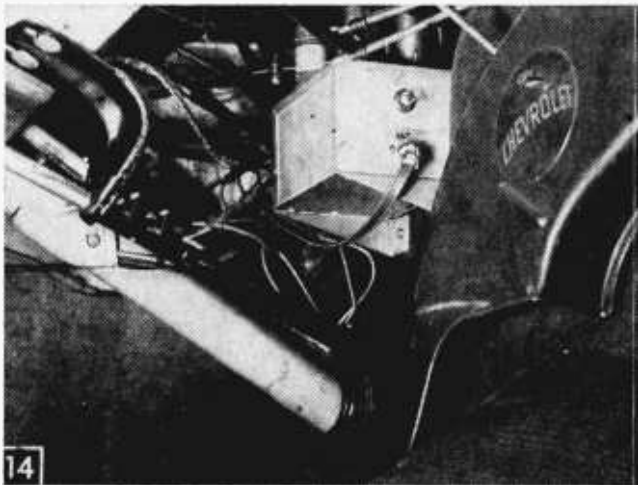
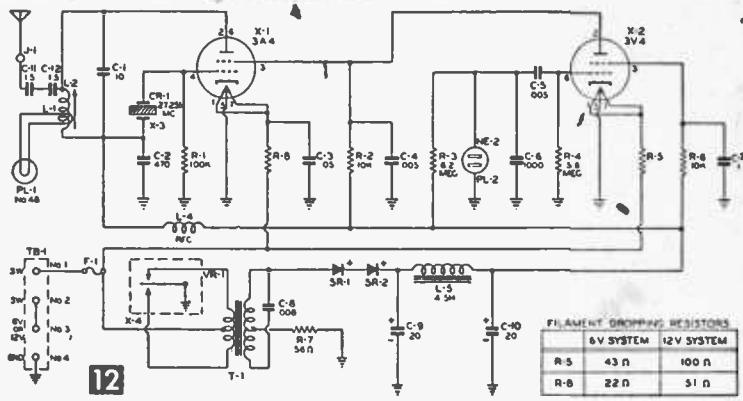

Transmitter mounted in car. Bracket fastens onto firewall up under dashboard, and just to right of steering column.

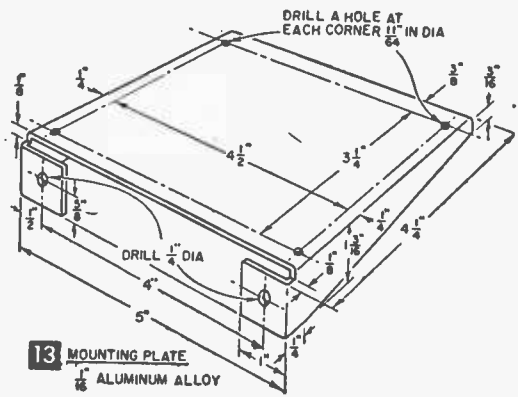

ing" (Fig. 8) until the transmitter signal is heard in the phones. The plate relay may or may not close, depending on the setting of the sensitivity control (R-10) controlled by the bar knob on top of the chassis.

This plate relay will tend to be unstable in its setting with the headphones plugged in, but the final adjustment is made with the headphones disconnected. As R-10 is rotated in the clockwise direction (looking at the top of the receiver) you will hear the plate relay click as it closes, and rotating the control shaft in the opposite direction will release the relay armature with a click.

As a further aid in tuning the receiver to a definite audio frequency, a variable padder capacitor (C-8) is connected across the secondary of the interstage audio transformer. With the transmitter turned on, a high resistance voltmeter, connected across the relay coil is used to adjust the padder until the highest reading is obtained on the voltmeter.

To further check the setting of the receiver sensitivity control, note that when the sensitivity control is set near the maximum sensitivity setting (just back of the point where you can hear

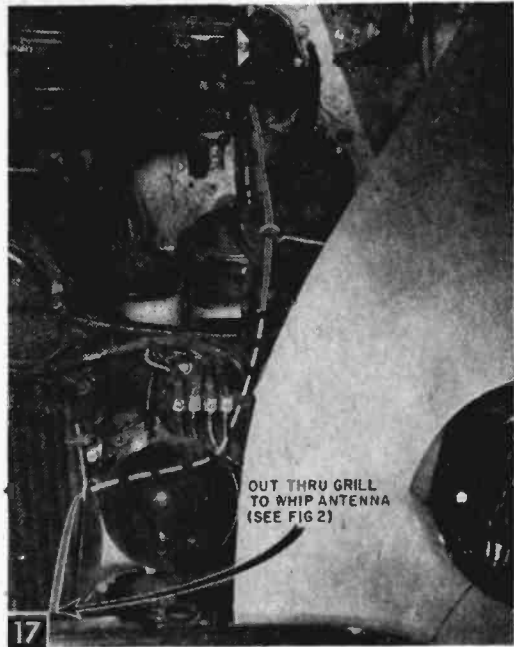
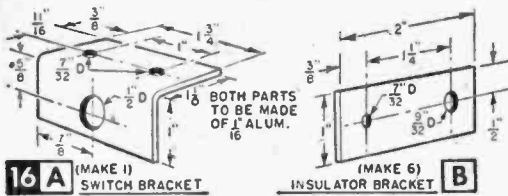
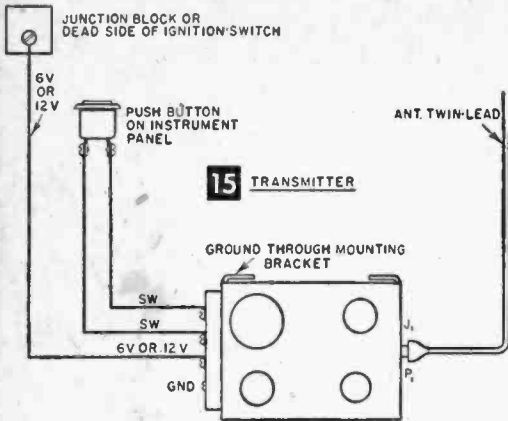

Note TV antenna lead-in wire starting at firewall in upper center, and supported by TV antenna insulator from side of fender, through radiator and horn support, with a TV insulator to left of horn. Lead then continues in back of lower grille bar, supported with pair of insulators in back of bumper guard, on out to location shown in Figure 2.

the relay armature open), pressing the transmitter button will operate the receiver relay immediately, as evidenced by the click of the plate relay closing. As you gradually change the setting of the sensitivity control counterclockwise, cutting down the sensitivity, the plate relay will not click closed (with the transmitter on) unless the transmitter button is pressed for several seconds, and finally will not close at all.

Set the sensitivity control where the plate relay does not click closing as soon as you press the transmitter button, but where it clicks upon pressing the transmitter button for 2 or 3 seconds, with the car parked about 25 feet from the garage. This adjustment prevents erratic operation of the plate relay, and yet gives you sufficient sensitivity for ordinary control. After testing, remember to set receiver control switch back to "on" position to make door mechanism operate.

Make the final adjustment of the tuning slug by backing the car 75-100 feet away and rechecking the setting with a pair of headphones.

Application to Commercial Opening Units. While we have described how to apply this radio control system to the motorized garage door control presented previously, note that the same radio control system can be readily applied to any commercial garage door opening unit, where the door operator can reverse the motor drive quickly each time the control button is pressed momentarily. One final word of caution: one condition of securing the FCC license is that all unnecessary transmission must be kept down to a minimum.

Clock Control. Some of you may want to add a clock control to limit the time when the equip-

ment is in operation. Here are the pros and cons of this effort to economize. Let's say you use the car for going to work and that your weekly working hours are fairly regular. The operating time for Monday through Friday can then be limited to an arrangement something like an "on" period from 6:30 to 8 am and from 4 pm to 1 am (to cover evening and nighttime use of the car). These hours are merely as a suggestion. Choose those that fit your own schedule, but allow an overlap of 15-30 minutes, before using the car in the morning, and the final use at night. For Saturdays and Sundays, the clock has a provision whereby the equipment is left on 24 hours a day.

You can install the clock by plugging it in the 110-volt circuit, and connecting the relay control box and the receiver to the clock (Figs. 20 and 21).

The hours of operation of the equipment are then determined by the setting of the clock dial—which gives the same operating hours for Monday through Friday. For Saturday and Sunday, the use of the skipping screws in the daily dial cuts out the "off" periods on the clock.

Figure 21 shows the connections to be made from the clock to the 110-volt line, and to the relay control box. These connections should be followed instead of the instructions supplied with the time switch. Also, the positions of the "on" and "off" trippers are reversed from the directions furnished. Where the directions

furnished specify that the "on" tripper is to be used, use the black-colored "off" type tripper instead. Where the "off" tripper is specified, use the silver-colored "on" tripper instead.

Fasten the red-marked tripper (which advances the 7-tooth ratchet once a day) on the time dial, just ahead of the "off" tripper, set for operating the clock in the early morning, in this case at 6:30 *am*. Figure 20 shows the trippers set in place. Note the two special screws (furnished with the switch) set in the weekly dial, one in the Saturday and the other in the Sunday holes (see arrows in Fig. 20). These screws keep the equipment turned on continuously on Saturdays and Sundays. To give two "on" and "off" periods daily, you'll need to purchase an extra set of "on" and "off" trippers when ordering the time switch.

The clock, a "Skipper" Time Switch Model TS66SPDT, is made by International Register Company. (Allied Radio Corp., 100 N. Western Avenue, Chicago 80, Ill. stocks it under No. 78B315.)

The time switch has a manual lever. To operate, push lever left if the equipment is off (disregard markings on the switch lever). Should the trippers on

the clock dial prevent you from moving the lever manually, pull the time dial outward temporarily while pushing the control lever to the left.

With the hours listed in the example given above, the control relay box and the receiver would be on about 100 hours, as against a weekly total of 168 hours.

To compare, assuming a 3¢ kilowatt hourly rate, without the clock the cost of operating the receiver and the relays in the control box (which draw a total of about 15 watts per hour) for 24 hours daily, is \$3.89 per year, or 32¢ per month. To this yearly total, add the cost of possibly two sets of receiver tubes at \$4.50 per

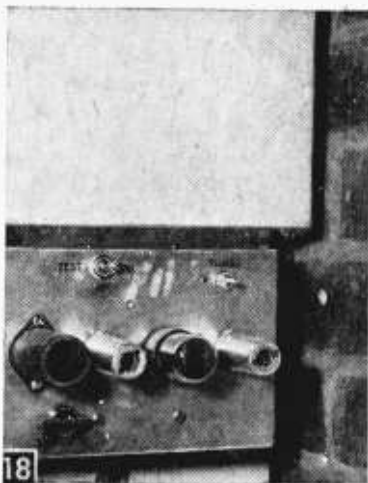

Receiver mounted directly below relay control box (see Fig. 1).

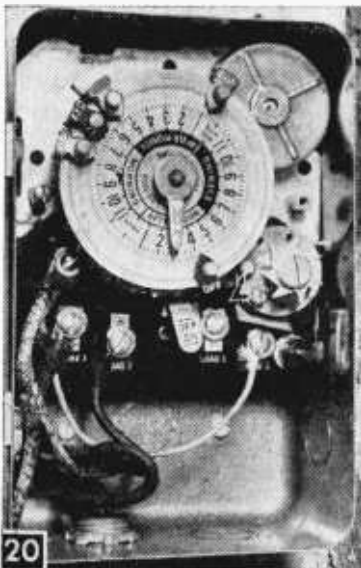

Closeup of time switch clock. Arrows indicate special screws which are set in Saturday and Sunday holes to permit full-time operations on weekends.

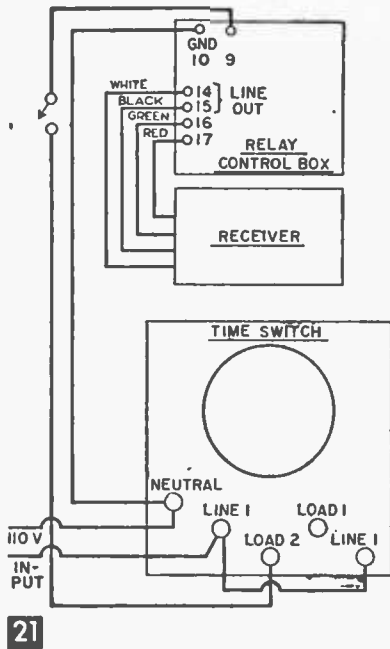
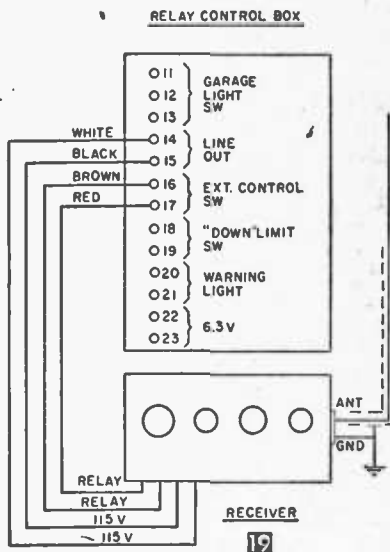

set (wholesale price) or \$9, making a total operating cost of \$12.89 per year. Incidentally, if you leave the receiver on, check tubes often.

On the other hand, the clock, drawing 2½ watts per hour and operating 24 hours daily, costs 65¢ per year to operate. The cost of operating the receiver and the relay box (100 hours per week) is \$2.34 per year. Only one set of tubes should be required for replacement, adding \$4.50 to the cost of operation, plus writing off the cost of the clock over a period of 10 years, or \$1.20 per year, adds up to a total of \$8.69 per year. Actual saving would be greater, since other parts would last longer.—END

ON LAND·IN THE AIR *and* ON THE SEA..

BIG MONEY

awaits
**TRAINED
 TECHNICIANS**
in
**TELEVISION·RADIO·
 ELECTRONICS·RADAR**

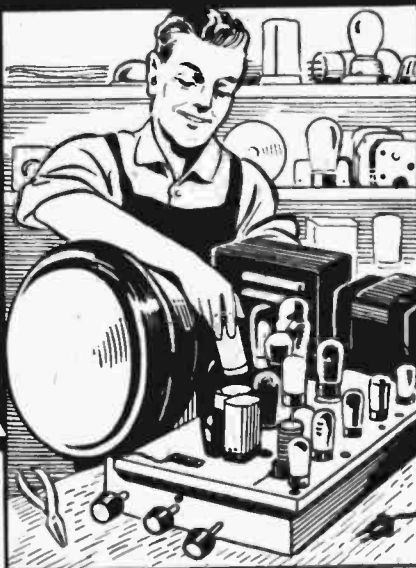

EARN *As You Learn*

Christy Shop-Method Home Training makes you a more valuable and desirable technician, assures you of more money, faster progress and greater success. This practical step-by-step training makes everything interesting and easy, makes learning fun.

You don't have to leave home or quit your job to learn this simple, easy way. A few hours of your spare time each week soon prepares you for earning while learning and later for a big-pay job or profitable business of your own in this fabulous, fast-growing new industry.

3 new books contain complete information. Describe the course and many opportunities in this fantastic new field. Send for your 3 free books today!

The Only Complete Course!

C.T.S. training covers every phase of this fascinating new subject. You get this comprehensive training starting with your first lesson. You learn Radar, Sonar, Television, Radio and Electronics in C.T.S.'s Complete course. This broader knowledge and greater understanding means more jobs and higher pay for you. Why be satisfied with less? You learn faster and better with Christy Shop-Method Home Training. It gives you all the training you need in a clear, simple, easy-to-understand way.

Big pay, interesting work, immediate success, await those thoroughly trained in all branches of electronics. And the C.T.S. Master Shop-Method Home Training Course is the only complete course in Radar, Sonar, Television, Radio and Electronics.

MAIL COUPON TODAY!

CHRISTY TRADES SCHOOL, INC.
 Dept. T-109, 4804 N. Kedzie Ave., Chicago 25, Ill.

Gentlemen:
 Please send me, without cost or obligation, two FREE Lessons and the new 24-page illustrated book telling all about the C.T.S. Master Shop-Method Home Training Course in Radar, Sonar, Television, Radio and Electronics, and the many opportunities this new field offers.

Name.....Age.....
 Address.....
 City.....State.....



19 TRAINING INSTRUMENTS INCLUDED

In a few months you learn what used to take years of hard work to master, reach your goal sooner and are better prepared to make maximum progress. Send for complete information today!

CHRISTY TRADES SCHOOL, INC.
 Dept. T-109
 4804 N. Kedzie, Chicago 25, Ill.

Special Offer to Buyers of RADIO-TV Experimenter

If you have enjoyed this handbook, you will be happy to know that the Editors of **SCIENCE AND MECHANICS**, the publishers of "Radio-TV Experimenter", have many more practical articles on radio and electronics scheduled for the forthcoming issues. At the newsstand, **SCIENCE AND MECHANICS** sells for 25c a copy. But by subscription, you get the next 12 issues for only \$2.00—a net savings of \$1.00 over the single copy price. And best of all, you will get your subscription copies before the magazine goes on sale on the newsstand. **Subscribe NOW!** Use the handy coupon **TODAY!**

12 BIG ISSUES
Only **\$2.00**



Here Are a Few of the Many Articles on RADIO and ELECTRONICS Scheduled for the Coming Issues of SCIENCE AND MECHANICS

- Radio Controlled Garage Door Opener
- Hidden Metal Detector
- What to Look for in Buying Hi-Fi
- Putting "Electric Eyes" to work
- New Uses for old Radio Parts
- Electronify Your Musical Instruments
- Midget Transistor Sets
- Radio Direction Finder
- Low Cost Speedlight
- Crystal Sets
- Shortwave Receivers
- Radio Telephone Station
- Electronic Detectophone
- Remote Controlled Model Fireboat
- TV Servicing

By subscribing to **SCIENCE AND MECHANICS**, you make sure that you don't miss a single model building article. Enjoy the pleasure and satisfaction of having America's foremost radio engineers supplying you with new ideas and plans for building a wide variety of radio projects. In addition to radio, **SCIENCE AND MECHANICS** brings you up-to-the-minute reports on the latest automotive, scientific and mechanical developments all over the world, plus scores and scores of "do-it-yourself" projects you can build in your shop. You'll enjoy **SCIENCE AND MECHANICS**. **Subscribe now at this bargain rate. Mail the coupon—NOW!**

SCIENCE AND MECHANICS MAGAZINE,
450 East Ohio Street, Dept. R-155 Chicago 11, Illinois

Enclosed is \$_____ for which enter my subscription to
SCIENCE AND MECHANICS for the period checked below:

- 12 Issues (\$3.00 Newsstand Value).....\$2.00*
 24 Issues (\$6.00 Newsstand Value).....\$3.50*

Start my subscription with the _____ issue.

NAME _____

ADDRESS _____

CITY, ZONE & STATE _____

*Outside U. S., its possessions and Canada, 12 Issues \$3.00; 24 Issues \$5.00

Send Today



Train for Better
Jobs in

ELECTRICITY OR TELEVISION-RADIO

in Great
Shops of COYNE

GREAT OPPORTUNITY FIELDS

Conditions are changing. Many "one operation" jobs that have paid well will not last. *Don't be satisfied with a "no future" job.* Whether 17 or up to 45 years of age, train the Coyne way for a better job and a real future in **ELECTRICITY** or **TELEVISION-RADIO**, fields that offer a world of opportunities.

YOU can TRAIN in great CHICAGO SHOPS

Train on real, full-size equipment at COYNE where thousands of successful men have trained for over 55 years—largest, oldest, best equipped school of its kind—established in 1899. No advanced education or previous experience needed. **TRAINING APPROVED FOR VETERANS.**

B. W. COOKE, President

COYNE
ELECTRICAL SCHOOL

FOUNDED 1899

A TECHNICAL TRADE INSTITUTE OPERATED NOT FOR PROFIT
500 S. PAULINA STREET, CHICAGO, Dept. 35-83M

ELECTRICITY ★ RADIO ★ TELEVISION ★ REFRIGERATION ★ ELECTRONICS

**COYNE offers
LOW COST**

TELEVISION RADIO-ELECTRONICS

Training in
Spare Time **AT HOME**

The future is **YOURS** in TV-RADIO!

A fabulous field—good pay—fascinating work—
a prosperous future! Good jobs, or independence
in your own business!

Coyne brings you the first *truly lower cost*, MODERN—QUALITY Television Home Training; training designed to meet Coyne standards. Not an old Radio Course with Television "tacked on". Here is MODERN TELEVISION TRAINING including working knowledge of Radio. Includes UHF and **COLOR TV**. No Radio background or previous experience needed. Personal guidance by Coyne Staff. **Practical Job Guides** to show you how to do actual servicing jobs—*make money early in course.* With Coyne Television Home Training you pay only for your training, *no costly "put together kits"*.

B. W. COOKE, President



Coyne—the Institution behind this training... the largest, oldest, best equipped residential school of its kind. Established 1899.

COYNE
ELECTRICAL SCHOOL

500 S. Paulina St., Dept. 35-HT6, Chicago 12
A TECHNICAL TRADE INSTITUTE OPERATED
NOT FOR PROFIT

START NOW—PAY LATER—Finance Plan and Easy Monthly Payment Plan. Also part-time employment help for students.

Get FREE Book

Send coupon for 48 page illustrated book "Guide to Careers in Electricity and Television-Radio." No cost; no obligation; no salesman will call. Get vital facts now!



B. W. COOKE, President
COYNE ELECTRICAL SCHOOL
500 S. Paulina St., Chicago 12, Ill., Dept. 35-83M

Send **BIG FREE** book and details of your training offer. This does not obligate me and no salesman will call. I am interested in:

Electricity Television-Radio

Name _____

Address _____

City _____

State _____



SEND COUPON FOR FREE BOOK

and full details,
including easy
Payment Plan.

**No obligation, no
salesman will call.**



COYNE ELECTRICAL SCHOOL

Television Home Training Div.
500 S. Paulina St., Chicago 12, Ill.,
Dept. 35-1176

Send Free Book and details on Television Home Training. This does not obligate me and no salesman will call.

Name _____

Address _____

City _____

State _____